



The following excerpt are pages from the North American Product Technical Guide, Volume 2: Anchor Fastening, Edition 19.

Please refer to the publication in its entirety for complete details on this product including data development, product specifications, general suitability, installation, corrosion and spacing and edge distance guidelines.

US&CA: <https://submittals.us.hilti.com/PTGVol2/>

To consult directly with a team member regarding our anchor fastening products, contact Hilti's team of technical support specialists between the hours of 7:00am – 6:00pm CST.

US: 877-749-6337 or [HNATechnicalServices@hilti.com](mailto:HNATechnicalServices@hilti.com)

CA: 1-800-363-4458, ext. 6 or [CATechnicalServices@hilti.com](mailto:CATechnicalServices@hilti.com)





1/2" diameter anchor data for CMU is bubbled for convenience

\*Grout-filled CMU See Pages 225,226



### 3.2.5 HIT-HY 270 HYBRID FOR MASONRY CONSTRUCTION

#### PRODUCT DESCRIPTION

##### HIT-HY 270 with Threaded Rod, Rebar, and HIS-N/RN Inserts

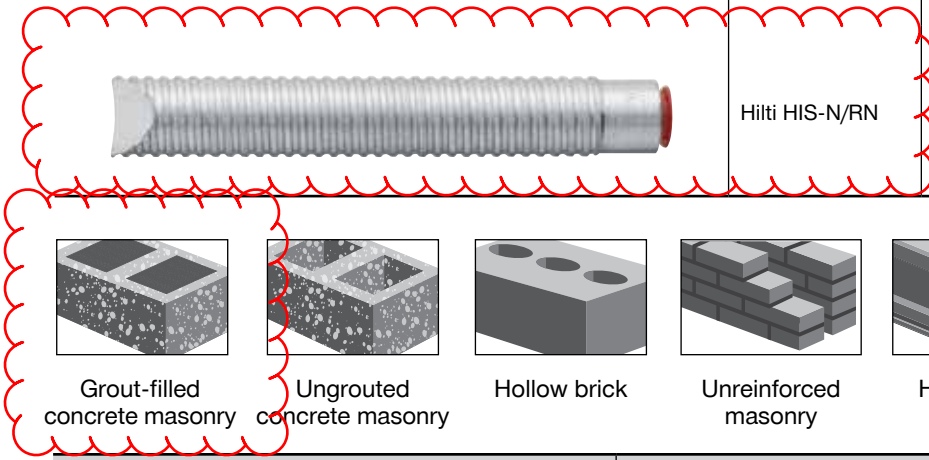
Anchor System	Features and Benefits
 <p>Hilti HIT-HY 270 Cartridge</p>	<ul style="list-style-type: none"> <li>• Injectable two-component hybrid adhesive mortar</li> <li>• For use in grouted and ungrouted concrete masonry block walls, solid and hollow brick walls and unreinforced multi-wythe brick walls referred to as unreinforced masonry or URM.</li> <li>• ICC-ES approved for grout-filled and ungrouted concrete masonry and hollow brick</li> <li>• ICC-ES approved for unreinforced masonry (URM)</li> </ul>
 <p>Hilti HAS Threaded Rods</p>	<ul style="list-style-type: none"> <li>• No hole cleaning requirement when installed with SafeSet™ hollow drill bit technology</li> </ul>
 <p>Rebar</p>	
 <p>Hilti HIS-N/RN</p>	

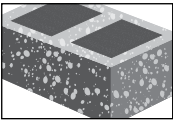
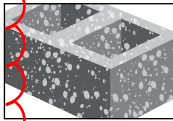
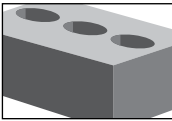
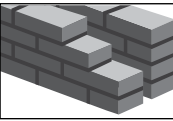
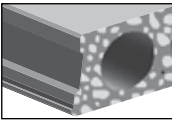
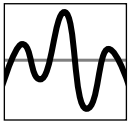

						
Grout-filled concrete masonry	UngROUTED concrete masonry	Hollow brick	Unreinforced masonry	Hollowcore concrete	Seismic Design categories A-F	Hollow drill bit

3.2.4

3.2.5

Approvals/Listings	
ICC-ES (International Code Council)	ESR-4143 in hollow and grout-filled CMU and hollow brick per ICC-ES AC58 ESR-4144 in unreinforced masonry per ICC-ES AC60
European Technical Approval	ETA-13/1036
City of Los Angeles	2017 LABC Supplement (within ESR-4143 and ESR-4144)
Florida Building Code	2017 FBC Supplement (within ESR-4143) w/ HVHZ
U.S. Green Building Council	LEED® Credit 4.1-Low Emitting Materials



## DESIGN DATA IN MASONRY

### HIT-HY 270 adhesive with Hilti HAS threaded rods and deformed reinforcing bars (Rebar)



Hilti HAS Threaded Rods



Deformed Reinforcing Bars (Rebar)

Permissible Base Materials	<p>Grout-filled concrete masonry</p>	Permissible drilling method	<p>Hammer drilling with carbide tipped drill bit</p>
			<p>Hilti TE-CD or TE-YD hollow drill bit</p>

**Figure 1 – Hilti HIT-HY 270 specifications for HAS threaded rod and reinforcing bars in grout-filled concrete masonry walls**

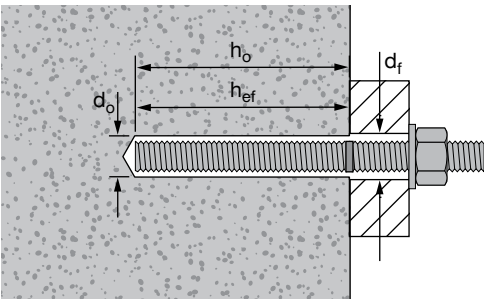

#### Hilti installation specifications for HAS threaded rod in grout-filled concrete masonry walls

Setting information	Symbol	Units	Nominal rod diameter (in.)			
			3/8	1/2	5/8	3/4
Nominal bit diameter	$d_o$	in.	7/16	9/16	3/4	7/8
Nominal / effective embedment	$h_o / h_{ef}$	in. (mm)	3-3/8 (86)	4-1/2 (114)	5-5/8 (143)	6-3/4 (171)
Installation torque	$T_{inst}$	ft-lb (Nm)	6 (8)	7.5 (10)	7.5 (10)	10 (13.5)
Diameter of fixture hole	$d_f$	in.	7/16	9/16	11/16	13/16

#### Hilti installation specifications for reinforcing bars in grout-filled concrete masonry walls

Setting information	Symbol	Units	Rebar size			
			#3	#4	#5	#6
Nominal bit diameter	$d_o$	in.	1/2	5/8	3/4	7/8
Nominal / effective embedment	$h_o / h_{ef}$	in. (mm)	3-3/8 (86)	4-1/2 (114)	5-5/8 (143)	6-3/4 (171)

**Table 1 – Hilti HIT-HY 270 allowable adhesive bond tension loads for threaded rods and reinforcing bars in the face of grout-filled concrete masonry walls<sup>1,2,3,4,5,6,7,8</sup>**

Nominal anchor diameter	Rebar size	Effective embedment in. (mm) <sup>11</sup>	Tension lb (kN)	Spacing <sup>9</sup>			Edge distance <sup>10</sup>		
				Critical $s_{cr}$ in. (mm)	Minimum $s_{min}$ in. (mm)	Load reduction factor @ $s_{min}$ <sup>12</sup>	Critical $c_{cr}$ in. (mm)	Minimum $c_{min}$ in. (mm)	Load reduction factor @ $c_{min}$ <sup>12</sup>
3/8	#3	3-3/8 (86)	1,240 (5.5)	13.5 (343)	4 (102)	0.70	12 (305)	4 (102)	0.80
1/2	#4	4-1/2 (114)	2,035 (9.1)	18 (457)		0.70	20 (508)		0.76
5/8	#5	5-5/8 (143)	2,840 (12.6)	22.5 (572)		0.50	20 (508)		0.71
3/4	#6	6-3/4 (171)	3,810 (16.9)	27 (686)		0.50	20 (508)		0.66

**Table 2 - Hilti HIT-HY 270 allowable adhesive bond shear loads for threaded rods and reinforcing bars in the face of grout-filled concrete masonry walls<sup>1,2,3,4,5,6,7,8</sup>**

Nominal anchor diameter	Rebar size	Effective embedment in. (mm) <sup>11</sup>	Shear lb (kN)	Spacing <sup>9</sup>			Edge distance <sup>10</sup>			
				Critical $s_{cr}$ in. (mm)	Minimum $s_{min}$ in. (mm)	Load reduction factor @ $s_{min}$ <sup>12</sup>	Critical $c_{cr}$ in. (mm)	Minimum $c_{min}$ in. (mm)	Load reduction factor @ $c_{min}$ <sup>12</sup>	
									Load perpendicular to edge	Load parallel to edge
3/8	#3	3-3/8 (86)	850 (3.8)	13.5 (343)	4 (102)	1.00	12 (305)	4 (102)	0.88	1.00
1/2	#4	4-1/2 (114)	1,495 (6.7)	18 (457)		1.00	12 (305)		0.49	1.00
5/8	#5	5-5/8 (143)	2,615 (11.6)	22.5 (572)		0.50	20 (508)		0.40	0.78
3/4	#6	6-3/4 (171)	4,090 (18.2)	27 (686)		0.50	20 (508)		0.26	0.60

The following footnotes apply to both Tables 1 and 2:

- All values are for anchors installed in fully grouted concrete masonry with minimum masonry prism strength of 1,500 psi. Concrete masonry units shall be lightweight, medium-weight or heavy-weight conforming to ASTM C90. Allowable loads are calculated using a safety factor of 5.
- Anchors may be installed in any location in the face of the masonry wall including cell, web, and mortar joints. Anchors are limited to one per masonry cell. See Figure 2
- Linear interpolation of load values between minimum spacing ( $s_{min}$ ) and critical spacing ( $s_{cr}$ ) and between minimum edge distance ( $c_{min}$ ) and critical edge distance ( $c_{cr}$ ) is permitted.
- Concrete masonry thickness must be equal to or greater than 1.5 times the anchor embedment depth. EXCEPTION: the 5/8-inch- and the 3/4-inch diameter anchors (No. 5 and No. 6 bars) may be installed in minimum nominally 8-inch thick concrete masonry.
- When using the basic load combinations in accordance with IBC Section 1605.3.1, tabulated allowable loads must not be increased for seismic or wind loading. When using the alternative basic load combinations in IBC Section 1605.3.2 that include seismic or wind loads, tabulated allowable loads may be increased by 33-1/3 percent, or the alternative basic load combinations may be reduced by a factor of 0.75.
- Allowable loads must be the lesser of the adjusted masonry or bond tabulated values and the steel values given in tables 3 and 4.
- Tabulated allowable loads shall be adjusted for increased base material temperatures in accordance with figure 13.
- For combined loading:  $(T_{applied}/T_{allowable})^n + (V_{applied}/V_{allowable})^n \leq 1$  where  $n = 5/3$  for 3/8- and 1/2-inch diameters (#3 and #4 rebar) and  $n = 1$  for 5/8- and 3/4-inch diameters (#5 and #6 rebar).
- The critical spacing,  $s_{cr}$ , is the anchor spacing where full load values may be used. The minimum spacing,  $s_{min}$ , is the minimum anchor spacing for which values are available and installation is recommended. Spacing is measured from the center of one anchor to the center of an adjacent anchor.
- The critical edge distance,  $c_{cr}$ , is the edge distance where full load values may be used. The minimum edge distance,  $c_{min}$ , is the minimum edge distance for which values are available and installation is recommended. Edge distance is measured from the center of the anchor to the closest edge.
- Embedment depth is measured from the outside face of the concrete masonry unit.
- Load reduction factors are multiplicative: both spacing and edge distance load reduction factors, and spacing and edge distances for all adjacent anchors/edges less than  $s_{cr}/c_{cr}$  must be considered. Load values for anchors installed at less than  $s_{cr}$  and  $c_{cr}$  must be multiplied by the appropriate load reduction factor based on actual edge distance ( $c$ ) and spacing ( $s$ ).

3.2.5

**Table 3 - Hilti HIT-HY 270 allowable tension and shear values for threaded rods based on steel strength<sup>1,2,3</sup>**

Anchor diameter in.	Tension lb (kN)						Shear lb (kN)					
	ISO 898 class 5.8	ASTM A36	ASTM F1554 Gr. 55	ASTM A307	ASTM A193 B7	ASTM F593 CW (316/304)	ISO 898 Class 5.8	ASTM A36	ASTM F1554 Gr. 55	ASTM A307	ASTM A193 B7	ASTM F593 CW (316/304)
1/4	1,175 (5.2)	940 (4.2)	- -	970 (4.3)	2,025 (9.0)	1,620 (7.2)	605 (2.7)	485 (2.2)	- -	500 (2.2)	1,040 (4.6)	835 (3.7)
5/16	1,835 (8.2)	1,470 (6.5)	- -	1,520 (6.8)	3,160 (14.1)	2,530 (11.3)	945 (4.2)	755 (3.4)	- -	780 (3.5)	1,630 (7.3)	1,300 (5.8)
3/8	2,640 (11.7)	2,115 (9.4)	2,730 (12.1)	2,185 (9.7)	4,555 (20.3)	3,645 (16.2)	1,360 (6.0)	1,090 (4.8)	1,410 (6.3)	1,125 (5.0)	2,345 (10.4)	1,875 (8.3)
1/2	4,700 (20.9)	3,755 (16.7)	4,860 (21.6)	3,885 (17.3)	8,100 (36.0)	6,480 (28.8)	2,420 (10.8)	1,935 (8.6)	2,505 (11.1)	2,000 (8.9)	4,170 (18.5)	3,335 (14.8)
5/8	7,340 (32.6)	5,870 (26.1)	7,595 (33.8)	6,075 (27.0)	12,655 (56.3)	10,125 (45.0)	3,780 (16.8)	3,025 (13.5)	3,910 (17.4)	3,130 (13.9)	6,520 (29.0)	5,215 (23.2)
3/4	10,570 (47.0)	8,455 (37.6)	10,935 (48.6)	8,750 (38.9)	18,225 (81.1)	12,390 (55.1)	5,445 (24.2)	4,355 (19.4)	5,635 (25.1)	4,505 (20.0)	9,390 (41.8)	6,385 (28.4)

**Table 4 - Hilti HIT-HY 270 allowable tension and shear values for reinforcing bars based on steel strength<sup>1,2,3</sup>**

Rebar size	Tension lb (kN)	Shear lb (kN)
	ASTM A615, GRADE 60	ASTM A615, GRADE 60
#3	3,270 (14.5)	1,685 (7.5)
#4	5,940 (26.4)	3,060 (13.6)
#5	9,205 (40.9)	4,745 (21.1)
#6	13,070 (58.1)	6,730 (29.9)

The following footnotes apply to both Tables 3 and 4:

- 1 Allowable load used in the design must be the lesser of bond values and tabulated steel values.
- 2 The allowable tension and shear values for threaded rods to resist short term loads, such as wind or seismic, must be calculated in accordance with the appropriate IBC Sections.
- 3 Allowable steel loads are based on tension and shear stresses equal to  $0.33 \times F_u$  and  $0.17 \times F_u$ , respectively.

**Figure 2 — Allowable anchor installation locations in the face of grout-filled concrete block**

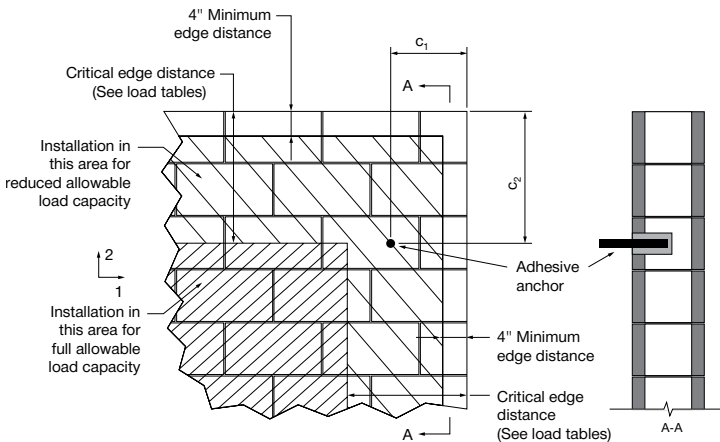

**Table 5 - Hilti HIT-HY 270 allowable adhesive bond loads for threaded rods and reinforcing bars in the top of grout-filled concrete masonry walls<sup>1,2,4,5,6,7,8</sup>**

Nominal anchor diameter or rebar size	Effective embedment in. (mm)	Edge distance in. (mm)	End distance in. (mm)	Spacing		Tension load <sup>9</sup>		Shear load <sup>9</sup>					
				Critical $s_{cr}$ in. (mm)	Minimum $s_{min}$ in. (mm)	@ $s_{cr}$ lb (kN)	Reduction factor @ $s_{min}$	Parallel to edge of masonry wall @ $s_{cr}$ lb (kN)	Perpendicular to edge of masonry wall @ $s_{cr}$ lb (kN)	Reduction Factor @ $s_{min}$			
1/2 <sup>3</sup>	4-1/2 (114)	1-3/4 (44)	8 (203)	16 (406)	3 (76)	1,165 (5.2)	0.57	815 (3.6)	345 (1.5)	0.50			
		4 (102)				1,625 (7.2)	0.50	1,445 (6.4)	505 (2.2)				
5/8 <sup>3</sup>	5-5/8 (143)	1-3/4 (44)				16 (406)	3 (76)	1,165 (5.2)	0.58		1,190 (5.3)	385 (1.7)	0.50
		4 (102)						1,590 (7.1)	0.50		1,825 (8.1)	655 (2.9)	
3/4 <sup>3</sup>	6-3/4 (171)	2-3/4 (70)				16 (406)	16 (406)	1,020 (4.5)	0.74		1,405 (6.3)	425 (1.9)	0.59
#4 <sup>10</sup>	4-1/2 (114)	1-3/4 (44)						865 (3.8)	1.00		635 (2.8)	245 (1.1)	
#5 <sup>10</sup>	5-5/8 (143)			980 (4.4)	755 (3.4)	295 (1.3)							

- All values are for anchors installed in fully grouted concrete masonry with minimum masonry prism strength of 1,500 psi. Concrete masonry units shall be lightweight, medium-weight or heavy-weight conforming to ASTM C90. Allowable loads are calculated using a safety factor of 5.
- When using the basic load combinations in accordance with IBC Section 1605.3.1, or the alternative basic load combinations in IBC Section 1605.3.2, tabulated allowable loads must not be increased for seismic or wind loading.
- One anchor shall be permitted to be installed in each cell.
- Anchors are not permitted to be installed in a head joint, flange or web of the concrete masonry unit.
- Allowable loads must be the lesser of the adjusted bond tabulated values and the steel values given in tables 3 and 4.
- Tabulated allowable loads shall be adjusted for increased base material temperatures in accordance with figure 13.
- For combined loading:  $(T_{applied}/T_{allowable})^n + (V_{applied}/V_{allowable})^n \leq 1$  where  $n = 5/3$  for 1/2-inch diameters (#4 rebar) and  $n = 1$  for 5/8-inch diameters (#5 rebar).
- The tabulated edge distance is measured from the anchor centerline to the edge of the concrete block. See figure 3.
- Linear interpolation of load values between the two tabulated edge distances is permitted.
- One anchor shall be permitted to be installed in each concrete block.

3.2.5

**Figure 3 – Edge and end distances for threaded rods and reinforcing bars installed in the top of grout-filled CMU**

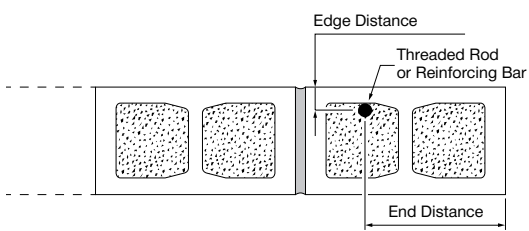
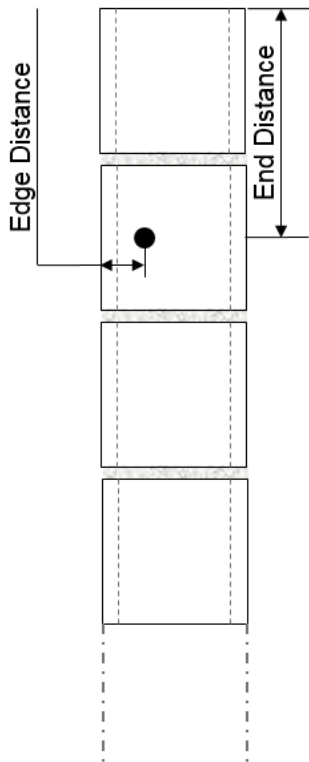

**Table 6 - Hilti HIT-HY 270 allowable adhesive bond loads for threaded rods and reinforcing bars in the side of grout-filled concrete masonry walls<sup>1,2,3,4,5,6,7,8</sup>**

Nominal anchor diameter or rebar size	Effective embedment in. (mm)	Minimum edge distance in. (mm)	Minimum end distance in. (mm)	Tension lb (kN)	Shear load, lb (kN)	
					Load parallel to edge of masonry wall	Load perpendicular to edge of masonry wall
1/2	4-1/2 (114)	1-3/4 (44)	8 (203)	990 (4.4)	885 (3.9)	255 (1.1)
5/8	5-5/8 (143)			1,200 (5.3)	1,220 (5.4)	330 (1.5)
3/4	5-5/8 (143)	2-3/4 (70)		1,200 (5.3)	1,770 (7.9)	530 (2.4)
#4	4-1/2 (114)	1-3/4 (44.5)		1,055 (4.7)	835 (3.7)	255 (1.1)
#5	5-5/8 (143)			1,160 (5.2)	990 (4.4)	275 (1.2)

- 1 All values are for anchors installed in fully grouted concrete masonry with minimum masonry prism strength of 1,500 psi. Concrete masonry units shall be lightweight, medium-weight or heavy-weight conforming to ASTM C90. Allowable loads are calculated using a safety factor of 5.
- 2 When using the basic load combinations in accordance with IBC Section 1605.3.1 or the alternative basic load combinations in IBC Section 1605.3.2. Tabulated allowable loads must not be increased for seismic or wind loading.
- 3 One anchor shall be permitted to be installed in each concrete block.
- 4 Anchors are not permitted to be installed in mortar joint of the concrete masonry unit.
- 5 Allowable loads must be the lesser of bond tabulated values and the steel values given in tables 3 and 4.
- 6 Tabulated allowable loads shall be adjusted for increased base material temperatures in accordance with figure 13.
- 7 Anchors installed on the side of the wall, shall have minimum of 16" vertical spacing.
- 8 For combined loading:  $(T_{\text{applied}}/T_{\text{allowable}}) + (V_{\text{applied}}/V_{\text{allowable}}) \leq 1$ , where  $n = 5/3$  for 1/2-inch diameters (#4 rebar) and  $n=1$  for 5/8-inch diameter or #5 and #6 rebar.

**Figure 4 – Edge and end distances for threaded rods and reinforcing bars installed in the side of grout-filled CMU**



HIT-HY 270 adhesive with Hilti HIS-N and HIS-RN internally threaded insert





Permissible Base Materials	 <p>Grout-filled concrete masonry</p>	Permissible drilling method	 <p>Hammer drilling with carbide tipped drill bit</p>
			 <p>Hilti TE-CD or TE-YD hollow drill bit</p>

Figure 5 – Hilti HIT-HY 270 specifications for HIS-N and HIS-RN inserts in grout-filled concrete masonry walls

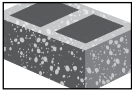

Hilti installation specifications for HIS-N and HIS-RN inserts in grout-filled concrete masonry walls

Setting information	Symbol	Units	Thread size	
			3/8-16 UNC	1/2-13 UNC
Nominal bit diameter	$d_o$	in.	11/16	7/8
Nominal / effective embedment	$h_o / h_{ef}$	in. (mm)	4-3/8 (110)	5 (125)
Installation torque	$T_{inst}$	ft-lb (Nm)	6 (8)	7.5 (10)
Diameter of fixture hole	$d_f$	in.	7/16	9/16
Thread engagement length	$h_s$	in. (mm)	3/8 to 15/16 (10 to 25)	1/2 to 1-1/4 (13 - 32)

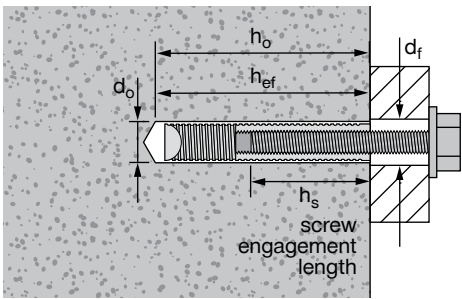
3.2.5



**Table 7 - Hilti HIT-HY 270 allowable adhesive bond tension loads for HIS-N and HIS-RN inserts in the face of grout-filled concrete masonry walls<sup>1,2,3,4,5,6,7,8</sup>**

Thread size	Effective embedment in. (mm) <sup>11</sup>	Tension lb (kN)	Spacing <sup>9</sup>			Edge distance <sup>10</sup>		
			Critical s <sub>cr</sub> in. (mm)	Minimum s <sub>min</sub> in. (mm)	Load reduction factor @ s <sub>min</sub> <sup>12</sup>	Critical c <sub>cr</sub> in. (mm)	Minimum c <sub>min</sub> in. (mm)	Load reduction factor @ c <sub>min</sub> <sup>12</sup>
3/8-16 UNC	4-3/8 (110)	2,075 (9.2)	17 (432)	4 (102)	0.55	12 (305)	4 (102)	0.82
1/2-13 UNC	5 (125)	2,710 (12.1)	20 (508)		0.55	20 (508)		0.63

**Table 8 - Hilti HIT-HY 270 allowable adhesive bond shear loads for HIS-N and HIS-RN inserts in the face of grout-filled concrete masonry walls<sup>1,2,3,4,5,6,7,8</sup>**

Thread size	Effective embedment in. (mm) <sup>11</sup>	Shear lb (kN)	Spacing <sup>9</sup>			Edge distance <sup>10</sup>			
			Critical s <sub>cr</sub> in. (mm)	Minimum s <sub>min</sub> in. (mm)	Load reduction factor @ s <sub>min</sub> <sup>12</sup>	Critical c <sub>cr</sub> in. (mm)	Minimum c <sub>min</sub> in. (mm)	Load reduction factor	
								Load perpendicular to edge	Load parallel to edge
3/8-16 UNC	4-3/8 (110)	1,100 (4.9)	17.0 (432)	4 (102)	0.74	12 (305)	4 (102)	0.72	1.00
1/2-13 UNC	5 (125)	2,065 (9.2)	20 (508)		0.71	20 (508)		0.40	0.87

The following footnotes apply to both Tables 7 and 8:





- All values are for anchors installed in fully grouted concrete masonry with minimum masonry prism strength of 1,500 psi. Concrete masonry units shall be lightweight, medium-weight or heavy-weight conforming to ASTM C90. Allowable loads are calculated using a safety factor of 5.
- Anchors may be installed in any location in the face of the masonry wall including cell, web, and mortar joints. Anchors are limited to one per masonry cell. See Figure 2.
- Linear interpolation of load values between minimum spacing (s<sub>min</sub>) and critical spacing (s<sub>cr</sub>) and between minimum edge distance (c<sub>min</sub>) and critical edge distance (c<sub>cr</sub>) is permitted.
- Concrete masonry thickness must be equal to or greater than 1.5 times the anchor embedment depth.
- When using the basic load combinations in accordance with IBC Section 1605.3.1, tabulated allowable loads must not be increased for seismic or wind loading. When using the alternative basic load combinations in IBC Section 1605.3.2 that include seismic or wind loads, tabulated allowable loads may be increased by 33-1/3 percent, or the alternative basic load combinations may be reduced by a factor of 0.75.
- Allowable loads must be the lesser of the adjusted bond tabulated values and the steel values given in tables 3 and 4.
- Tabulated allowable loads shall be adjusted for increased base material temperatures in accordance with figure 13.
- For combined loading:  $(T_{\text{applied}} / T_{\text{allowable}})^n + (V_{\text{applied}} / V_{\text{allowable}})^n \leq 1$  where  $n = 5/3$
- The critical spacing, s<sub>cr</sub>, is the anchor spacing where full load values may be used. The minimum spacing, s<sub>min</sub>, is the minimum anchor spacing for which values are available and installation is recommended. Spacing is measured from the center of one anchor to the center of an adjacent anchor.
- The critical edge distance, c<sub>cr</sub>, is the edge distance where full load values may be used. The minimum edge distance, c<sub>min</sub>, is the minimum edge distance for which values are available and installation is recommended. Edge distance is measured from the center of the anchor to each edge.
- Embedment depth is measured from the outside face of the concrete masonry unit.
- Load reduction factors are multiplicative: both spacing and edge distance load reduction factors, and spacing and edge distances for all adjacent anchors/edges less than s<sub>cr</sub>/c<sub>cr</sub>, must be considered. Load values for anchors installed at less than s<sub>cr</sub> and c<sub>cr</sub> must be multiplied by the appropriate load reduction factor based on actual edge distance (c) and spacing (s).

HIT-HY 270 adhesive with Hilti HAS threaded rods and Hilti HIT-IC Inserts

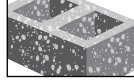

Hilti HAS Threaded Rods

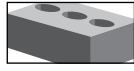
Hilti HIT-IC Inserts

Permissible Base Materials		Ungrouted Concrete Masonry	Permissible drilling method		Rotary only drilling with carbide tipped drill bit
		Brick with Holes			Hilti TE-CD or TE-YD Hollow Drill Bit

Hilti installation specifications for HAS threaded rod in hollow masonry and brick with holes

Setting information	Symbol	Units	Nominal rod diameter (in.)			
			1/4	5/16	3/8	1/2
Nominal bit diameter	$d_o$	in.	1/2	5/8	5/8	11/16
Screen size, CMU	HIT-SC	-	12x50	16x50	16x50	18x50
Depth drilled, CMU	$h_o$	in. (mm)	Through face shell			
Effective embedment, CMU	$h_{ef}$	in. (mm)	2 (50)	2 (50)	2 (50)	2 (50)
Screen size, Brick	HIT-SC	-	12x85	16x85	16x85	18x85
Depth drilled, Brick	$h_o$	in. (mm)	3-3/4 (95)	3-3/4 (95)	3-3/4 (95)	3-3/4 (95)
Effective embedment, Brick	$h_{ef}$	in. (mm)	3-1/8 (79)	3-1/8 (79)	3-1/8 (79)	3-1/8 (79)
Installation torque	$T_{inst}$	ft-lb (Nm)	2.2 (3)	2.2 (3)	3 (4)	4.5 (6)
Diameter of fixture hole	$d_f$	in.	9/32	3/8	7/16	9/16

Figure 6 – Hilti HIT-HY 270 specifications for Hilti HAS threaded rod in hollow masonry and brick with holes

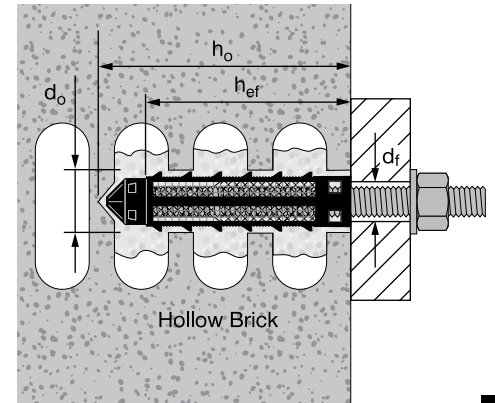

3.2.5

Hilti installation specifications for #14 screw in hollow masonry and brick with holes

Setting information	Symbol	Units	CMU	Brick
Nominal bit diameter	$d_o$	in.	1/2	1/2
Screen size	HIT-S	-	12/1	12/1
Depth drilled	$h_o$	in. (mm)	Through face shell	2 (50)
Effective embedment	$h_{ef}$	in. (mm)	2 (50)	2 (50)
Diameter of fixture hole	$d_f$	in.	9/32	9/32

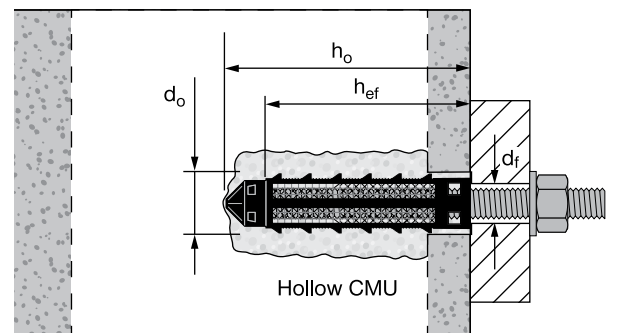

**Table 9 - Hilti HIT-HY 270 allowable adhesive bond loads for threaded rods in the face of hollow concrete masonry units<sup>1,3,7,9,10</sup>**

Nominal anchor diameter in.	Embedment in. (mm) <sup>2</sup>	Tension load lb (kN)		Critical and minimum edge distance for tension, $c_{cr}$ and $c_{min}$ in (mm)	Shear load at $c_{cr}$ lb (kN)		Edge distances for shear <sup>6</sup>		
		Installation in the cell lb (kN) <sup>4,5,8</sup>	Installation in the bed joint lb (kN) <sup>5,8</sup>		Installation in the cell lb (kN) <sup>4,5,8</sup>	Installation in the bed joint lb (kN) <sup>5,8</sup>	Critical $c_{cr}$ in. (mm)	Minimum $c_{min}$ in. (mm)	Load reduction factor @ $c_{min}$
1/4	2 (51)	220 (1.0)	300 (1.3)	4 (102)	355 (1.6)	385 (1.7)	4 (102)	4 (102)	1.00
5/16		390 (1.7)	300 (1.3)		630 (2.8)	435 (1.9)	12 (305)		0.73
3/8		390 (1.7)	300 (1.3)		645 (2.9)	550 (2.4)	12 (305)		0.73
1/2		390 (1.7)	330 (1.5)		670 (3.0)	755 (3.4)	12 (305)		0.73

**Table 10 - Hilti HIT-HY 270 allowable adhesive bond loads for Hilti HIT-IC inserts in the face of hollow concrete masonry units<sup>1,3,7,9,10</sup>**

Nominal anchor diameter in.	Embedment in. (mm) <sup>2</sup>	Tension load, installation in the cell lb (kN) <sup>4,5,8</sup>	Critical and minimum edge distance for tension, $c_{cr}$ and $c_{min}$ in (mm)	Shear load, installation in the cell lb (kN) <sup>4,5,8</sup>	Edge distances for shear <sup>6</sup>		
					Critical $c_{cr}$ in. (mm)	Minimum $c_{min}$ in. (mm)	Load reduction factor @ $c_{min}$
#14 Screw	2 (51)	190 (0.8)	4 (102)	235 (1.0)	4 (102)	4 (102)	1.00
5/16-18 UNC		415 (1.8)		605 (2.7)	12 (305)		0.80
3/8-16 UNC		480 (2.1)		620 (2.8)	12 (305)		0.78
1/2-13 UNC		495 (2.2)		620 (2.8)	12 (305)		0.75

**The following footnotes apply to both Tables 9 and 10:**

- All values are for anchors installed in hollow concrete masonry with minimum masonry strength of 1500 psi. Concrete masonry units must be light-, medium, normal-weight conforming to ASTM C90. Allowable loads have been calculated using a safety factor of 5.
- Tabulated embedment depth is limited by the length of the plastic HIT-SC screens.
- Anchors must be installed in the face of the hollow CMU masonry wall. A maximum of two anchors may be installed in a single cell of the hollow CMU block.
- Tabulated values are for anchors installed in the cell of the hollow CMU. Installation in other locations of the hollow CMU (mortar joints, flange, or cell web) is not permitted.
- Two anchors may be spaced as close as 4 inches apart with no reduction in tension or shear capacity. EXCEPTION: Two 3/8-inch diameter HIT-IC inserts and two 1/2-inch diameter HIT-IC inserts installed in the same cell spaced as close as 4 inches require a 20% reduction in the tension capacity.
- The critical edge distance,  $c_{cr}$ , is the edge distance where full load values in the table may be used. The minimum edge distance,  $c_{min}$ , is the minimum edge distance for which values are available and installation is permitted. Edge distance is measured from the center of the anchor to any edge.
- Anchors are not recognized for resisting earthquake forces. When using the basic load combinations in accordance with IBC Section 1605.3.1, or the alternative basic load combinations in IBC Section 1605.3.2, tabulated allowable loads must not be increased for wind loading.
- Allowable loads must be the lesser of the adjusted bond values tabulated above and the steel values given in Table 3.
- Tabulated allowable bond loads must be adjusted for increased base material temperatures in accordance with Figure 13, as applicable.
- For combined loading:  $(T_{applied} / T_{allowable}) + (V_{applied} / V_{allowable}) \leq 1$

**Figure 7 – Hilti HIT-HY 270 specifications for Hilti HIT-IC in hollow masonry and brick with holes**

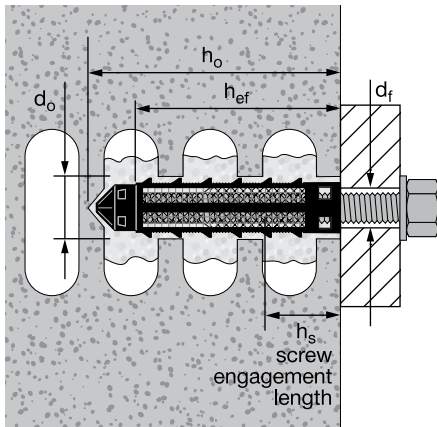

**Hilti installation specifications for Hilti HIT-IC in hollow masonry and brick with holes**

Setting information	Symbol	Units	Nominal rod diameter (in.)		
			5/16	3/8	1/2
Nominal bit diameter	$d_o$	in.	5/8	7/8	7/8
HIT-IC size, CMU	HIT-IC	-	5/16x2	3/8x2	1/2x2
Screen size, CMU	HIT-SC	-	16x50	22x50	22x50
Nominal embedment, CMU	$h_o$	in. (mm)	2-3/8 (60)	2-3/8 (60)	2-3/8 (60)
Effective embedment, CMU	$h_{ef}$	in. (mm)	2 (50)	2 (50)	2 (50)
Screw engagement length, CMU	$h_s$	in. (mm)	3/8 - 1 1/2 (9.5 - 38)	3/8 - 1 1/2 (9.5 - 38)	1/2 - 1 1/2 (12.5 - 38)
HIT-IC size, Brick	HIT-IC	-	5/16x3-3/16	3/8x3-3/16	1/2x3-3/16
Screen size, Brick	HIT-SC	-	16x85	22x85	22x85
Nominal embedment, Brick	$h_o$	in. (mm)	3-3/4 (95)	3-3/4 (95)	3-3/4 (95)
Effective embedment, Brick	$h_{ef}$	in. (mm)	3-1/8 (79)	3-1/8 (79)	3-1/8 (79)
Screw engagement length, Brick	$h_s$	in. (mm)	3/8 - 3 (9.5 - 76)	3/8 - 3 (9.5 - 76)	1/2 - 3 (12.5 - 76)
Installation torque	$T_{inst}$	ft-lb (Nm)	2.2 (3)	3 (4)	4.5 (6)
Diameter of fixture hole	$d_f$	in.	3/8	7/16	9/16

3.2.5

**Table 11 - Hilti HIT-HY 270 allowable adhesive bond tension loads for threaded rods in the face of hollow brick<sup>1,3,4,8,9,10,11</sup>**

Nominal anchor diameter in.	Effective embedment in. (mm) <sup>2</sup>	Tension lb (kN)	Spacing <sup>5</sup>			Edge distance <sup>6</sup>		
			Critical s <sub>cr</sub> in. (mm)	Minimum s <sub>min</sub> in. (mm)	Load reduction factor @ s <sub>min</sub> <sup>7</sup>	Critical c <sub>cr</sub> in. (mm)	Minimum c <sub>min</sub> in. (mm)	Load reduction factor @ c <sub>min</sub> <sup>7</sup>
1/4	3-1/8 (79)	530 (2.4)	8 (203)	4 (102)	0.88	6 3/8 (162)	4 (102)	0.93
5/16		735 (3.3)			0.82			0.80
3/8		905 (4.0)			0.54			0.83
1/2		905 (4.0)			0.50			1.00

**Table 12 - Hilti HIT-HY 270 allowable adhesive bond shear loads for threaded rods in the face of hollow brick<sup>1,3,4,8,9,10,11</sup>**

Nominal anchor diameter in.	Effective embedment in. (mm) <sup>2</sup>	Shear lb (kN)	Spacing <sup>5</sup>			Edge distance <sup>6</sup>		
			Critical s <sub>cr</sub> in. (mm)	Minimum s <sub>min</sub> in. (mm)	Load reduction factor @ s <sub>min</sub> <sup>7</sup>	Critical c <sub>cr</sub> in. (mm)	Minimum c <sub>min</sub> in. (mm)	Load reduction factor @ c <sub>min</sub> <sup>7</sup>
1/4	3-1/8 (79)	370 (1.6)	8 (203)	4 (102)	0.84	4 (102)	4 (102)	0.86
5/16		595 (2.6)			0.81			0.93
3/8		1,045 (4.6)			0.59			0.54
1/2		1,685 (7.5)			0.50			0.36

**The following footnotes apply to both Tables 11 and 12:**

- All values are for anchors installed in hollow brick masonry with minimum masonry strength of 3000 psi. Hollow brick units must be in conformance with ASTM C652. Allowable loads have been calculated using a safety factor of 5.
- Tabulated embedment depth is limited by the length of the plastic HIT-SC screens.
- Anchors must be installed in the face of the hollow brick masonry wall.
- Tabulated values are for the anchor installed in the center of the hollow brick, mortar joints, flanges, or cell web (all wall face locations permitted).
- The critical spacing, s<sub>cr</sub>, is the anchor spacing where full load values in the table may be used. The minimum spacing, s<sub>min</sub>, is the minimum anchor spacing for which values are available and installation is recommended. Spacing is measured from the center of one anchor to the center of an adjacent anchor.
- The critical edge distance, c<sub>cr</sub>, is the edge distance where full load values in the table may be used. The minimum edge distance, c<sub>min</sub>, is the minimum edge distance for which values are available and installation is permitted. Edge distance is measured from the center of the anchor to each edge.
- Load reduction factors are multiplicative: both spacing and edge distance load reduction factors, and spacing and edge distances for all adjacent anchors/edges less than s<sub>cr</sub>/c<sub>cr</sub>, must be considered. Load values for anchors installed at less than s<sub>cr</sub> and c<sub>cr</sub> must be multiplied by the appropriate load reduction factor based on actual edge distance (c) and spacing (s).
- Anchors are not recognized for resisting earthquake forces. When using the basic load combinations in accordance with IBC Section 1605.3.1, or the alternative basic load combinations in IBC Section 1605.3.2, tabulated allowable loads must not be increased for wind loading.
- Allowable loads must be the lesser of the adjusted bond tabulated values and the steel values given in table 3.
- Tabulated allowable bond loads must be adjusted for increased base material temperatures in accordance with Figure 13, as applicable.
- For combined loading:  $(T_{\text{applied}} / T_{\text{allowable}}) + (V_{\text{applied}} / V_{\text{allowable}}) \leq 1$

**Table 13 - Hilti HIT-HY 270 allowable adhesive bond loads for HIT-IC inserts in the face of hollow brick<sup>1,3,4,5,7,8,9,10</sup>**

Thread size	Effective embedment in. (mm) <sup>2</sup>	Tension lb (kN)	Critical and minimum edge distance for tension, c <sub>cr</sub> and c <sub>min</sub> in. (mm)	Shear lb (kN)	Edge distance for shear <sup>6</sup>		
					Critical c <sub>cr</sub> in. (mm)	Minimum c <sub>min</sub> in. (mm)	Load reduction factor @ c <sub>min</sub>
#14 Screw	2 (51)	170 (0.8)	6 3/8 (162)	222 (1.0)	8 (203)	8 (203)	1.00
5/16-18 UNC	3-1/8 (79)	880 (3.9)		655 (2.9)	8 (203)		1.00
3/8-16 UNC		880 (3.9)		1,235 (5.5)	12 (305)		0.66
1/2-13 UNC		990 (4.4)		1,895 (8.4)	12 (305)		0.44

- 1 All values are for anchors installed in hollow brick masonry with minimum masonry strength of 3000 psi. Hollow brick units must be in conformance with ASTM C652. Allowable loads have been calculated using a safety factor of 5.
- 2 Tabulated embedment depth is limited by the length of the plastic HIT-SC screens.
- 3 Anchors must be installed in the face of the hollow brick masonry wall.
- 4 Tabulated values are for one anchor installed in the hollow brick, mortar joints, flanges, or cell web (all wall face locations permitted).
- 5 One anchor is permitted to be installed in each brick. Two anchors installed in adjacent bricks may be spaced as close as 8 inches apart with no load reduction.
- 6 The critical edge distance, c<sub>cr</sub>, is the edge distance where full load values in the table may be used. The minimum edge distance, c<sub>min</sub>, is the minimum edge distance for which values are available and installation is permitted. Edge distance is measured from the center of the anchor to each edge.
- 7 Anchors are not recognized for resisting earthquake forces. When using the basic load combinations in accordance with IBC Section 1605.3.1, or the alternative basic load combinations in IBC Section 1605.3.2, tabulated allowable loads must not be increased for wind loading.
- 8 Allowable loads must be the lesser of the adjusted bond tabulated values and the steel values given in table 3.
- 9 Tabulated allowable bond loads must be adjusted for increased base material temperatures in accordance with Figure 13, as applicable.
- 10 For combined loading:  $(T_{\text{applied}}/T_{\text{allowable}}) + (V_{\text{applied}}/V_{\text{allowable}}) \leq 1$

### HIT-HY 270 adhesive with Hilti HAS threaded rods and deformed reinforcing bars (Rebar)



Hilti HAS Threaded Rods



Deformed Reinforcing Bars (Rebar)

Permissible Base Materials		Unreinforced Multi-wythe Brick (URM)	Permissible drilling method		Rotary only drilling with carbide tipped drill bit

**Figure 8 - Hilti HIT-HY 270 specifications for HAS rods in multi-wythe brick wall**

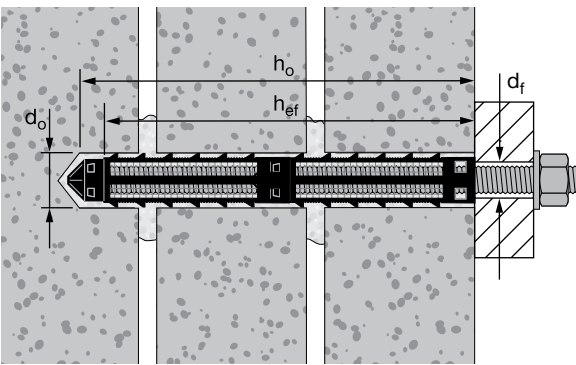

### Hilti installation specifications for HAS rods in multi-wythe brick wall

Setting information	Symbol	Units	Nominal rod diameter (in.)							
			3/8		1/2		5/8		3/4	
Nominal bit diameter	$d_o$	in.	5/8		11/16		7/8		1	
Screen size	HIT-SC	-	2x 16x85	3x 16x85	2x 18x85	3x 18x85	2x 22x85	3x 22x85	26x200	26x125 + 26x200
Nominal embedment	$h_o$	in. (mm)	7-1/8 (181)	10-3/4 (273)	7-1/8 (181)	10-3/4 (273)	7-1/8 (181)	10-3/4 (273)	8-1/4 (210)	13-1/4 (337)
Effective embedment	$h_{ef}$	in. (mm)	6 (152)	10 (254)	6 (152)	10 (254)	6 (152)	10 (254)	8 (203)	13 (330)
Installation torque	$T_{inst}$	ft-lb	10		30		45		60	
		(Nm)	(14)		(41)		(61)		(81)	
Diameter of fixture hole	$d_f$	in.	7/16		9/16		11/16		13/16	

**Hilti installation specifications for rebar in multi-wythe brick wall**

Setting information	Symbol	Units	Nominal rod diameter (in.)		
			#4	#5	#6
Nominal bit diameter	$d_o$	in.	1	1	1
Screen size	HIT-SC	-	26x200	26x200	26x200
Nominal embedment	$h_o$	in. (mm)	8-1/4 (210)	8-1/4 (210)	8-1/4 (210)
Effective embedment	$h_{ef}$	in. (mm)	8 (203)	8 (203)	8 (203)

**Figure 9 – Hilti HIT-HY 270 specifications for rebar in multi-wythe brick wall**

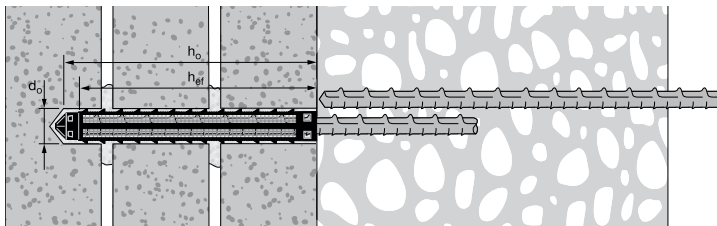

**Table 14 - Hilti HIT-HY 270 allowable adhesive bond loads for threaded rods in multi-wythe solid brick wall<sup>1,2,3,4,5,6,8,9</sup>**

Nominal anchor diameter in.	Effective embedment <sup>7</sup> in. (mm)	Tension lb (kN)	Shear lb (kN)	Spacing			Edge distance		
				Critical $s_{cr}$ in. (mm)	Minimum $s_{min}$ in. (mm)	Load reduction factor@ $s_{min}$	Critical $c_{cr}$ in. (mm)	Minimum $c_{min}$ in. (mm)	Load reduction factor@ $c_{min}$
3/8	6 (152)	895 (4.0)	680 (3.0)	16 (406)	8 (203)	0.50	16 (406)	8 (203)	0.50
	10 (254)	1,325 (5.9)	795 (3.5)						
1/2	6 (152)	895 (4.0)	1,075 (4.8)						
	10 (254)	1,455 (6.5)	1,115 (5.0)						
5/8	6 (152)	1,025 (4.6)	1,405 (6.3)						
	10 (254)	1,955 (8.7)	1,445 (6.4)						
3/4	8 (203)	1,575 (7.0)	1,985 (8.8)						
	13 (330)	2,135 (9.5)	1,985 (8.8)						

3.2.5

- All values are based on mortar shear strength of 45 psi or greater. Allowable loads are calculated using a safety factor of 5.
- Anchors must be installed in the face of the multi-wythe URM wall. The wall must have a minimum thickness of 13 inches made up of 3 wythes of brick.
- Tabulated values are for maximum one anchor installed in the center of the brick of the multi-wythe URM wall.
- Edge distance,  $c_{min}$ , and spacing,  $s_{min}$ , are the minimum distances for which values are available and installation is recommended. Edge distance is measured from the center of the anchor to each edge. Spacing is measured from the center of one anchor to the center of an adjacent anchor.
- Allowable loads must be the lesser of the adjusted bond tabulated values and the steel values given in table 3.
- Allowable loads shall be adjusted for increased base material temperature in accordance with Figure 13.
- Tabulated embedment depth is limited by the length of the plastic HIT-SC screens.
- For combined loading:  $(T_{applied} / T_{allowable}) + (V_{applied} / V_{allowable}) \leq 1$
- Load reduction factors are multiplicative: both spacing and edge distance load reduction factors, and spacing and edge distances for all adjacent anchors/ edges less than  $s_{cr} / c_{cr}$  must be considered. Load values for anchors installed at less than  $s_{cr}$  and  $c_{cr}$  must be multiplied by the appropriate load reduction factor based on actual edge distance (c) and spacing (s).

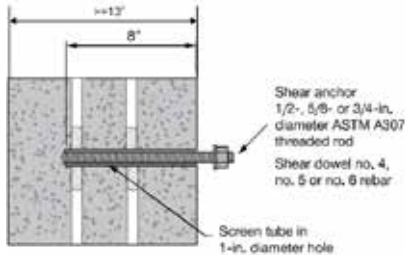

**Table 15 - Hilti HIT-HY 270 allowable adhesive bond loads for threaded rods in multi-wythe hollow brick wall** <sup>1,3,4,5,7,8</sup>

Nominal anchor diameter in.	Effective embedment in. (mm) <sup>6</sup>	Tension lb (kN)	Shear lb (kN)	Minimum edge distance $c_{min}$ in. (mm)	Spacing			
					Critical $s_{cr}$ in. (mm)	Minimum $s_{min}$ in. (mm)	Load reduction factor in tension @ $s_{min}$	Load reduction factor in shear @ $s_{min}$
Anchor installed into the face of brick masonry wall <sup>2</sup>								
3/8	6-1/4 (160)	880 (3.9)	560 (2.5)	4 (102)	16 (406)	8 (203)	0.89	1.00
	9-3/4 (248)	1,540 (6.9)	895 (4.0)				0.96	0.75
1/2	6-1/4 (160)	1,430 (6.4)	655 (2.9)				0.59	0.75
	9-3/4 (248)	2,020 (9.0)	895 (4.0)				0.89	0.78
5/8	6-1/4 (160)	1,695 (7.5)	655 (2.9)				0.50	0.71
	9-3/4 (248)	2,165 (9.6)	895 (4.0)				0.71	0.58
3/4	8 (203)	1,380 (6.1)	855 (3.8)				1.00	0.67
	10 (250)	2,075 (9.2)	1,070 (4.8)				0.79	0.54
Anchor installed into the top of brick masonry wall								
3/8	3-1/8 (79)	315 (1.4)	220 (1.0)	2.5 (64)	8 (203)	8 (203)	1	1
Anchor installed into the side of brick masonry wall								
3/8	3-1/8- (79)	570 (2.5)	290 (1.3)	2.5 (64)	8 (203)	8 (203)	1	1

- 1 All values are for anchors installed in brick masonry with minimum masonry strength of 3000 psi. Brick units must be in conformance with ASTM C652. Allowable loads have been calculated using a safety factor of 5.
- 2 Anchors must be installed in the face of the multi-wythe URM wall. 2-wythe brick walls must have minimum of 6 inches thickness. Anchors with the effective embedment larger than 6-1/4" inches must be installed in the wall with minimum thickness of 13 inches made up of 3-wythe brick walls.
- 3 Edge distance,  $c_{min}$ , and spacing,  $s_{min}$ , are the minimum distances for which values are available and installation is recommended. Edge distance is measured from the center of the anchor to each edge. Spacing is measured from the center of one anchor to the center of an adjacent anchor.
- 4 Allowable loads must be the lesser of the adjusted bond tabulated values and the steel values given in table 3.
- 5 Allowable loads shall be adjusted for increased base material temperature in accordance with Figure 13.
- 6 Tabulated embedment depth is limited by the length of the plastic HIT-SC screens.
- 7 For combined loading:  $(T_{applied} / T_{allowable}) + (V_{applied} / V_{allowable}) \leq 1$
- 8 Load reduction factors are multiplicative: both spacing and edge distance load reduction factors, and spacing and edge distances for all adjacent anchors/ edges less than  $s_{cr}/c_{cr}$ , must be considered. Load values for anchors installed at less than  $s_{cr}$  and  $c_{cr}$  must be multiplied by the appropriate load reduction factor based on actual edge distance (c) and spacing (s).

**Figure 10 – Hilti HIT-HY 270 shear anchor or dowel in configuration A**



**Figure 11 – Hilti HIT-HY 270 with 22-1/2° combination anchor in configuration B**

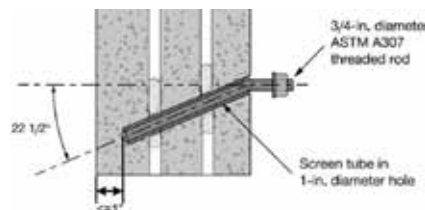

**Table 16 - Hilti HIT-HY 270 allowable adhesive bond seismic loads for threaded rods and reinforcing bars in unreinforced brick masonry** <sup>1,2,3</sup>

Configuration A – Shear anchor or rebar dowel				
Nominal anchor diameter (in.) or rebar size	Embedment in. (mm)	Minimum wall thickness in. (mm)	Tension lb (kN)	Shear lb (kN) <sup>4</sup>
1/2 or # 4	8 (203)	13 (330)	-	500 (2.2)
5/8 or # 5			-	750 (3.3)
3/4 or # 6			-	1,000 (4.4)
Configuration B – 22 1/2° combination anchor				
Nominal anchor diameter (in.)	Embedment in. (mm)	Minimum wall thickness in. (mm)	Tension lb (kN)	Shear lb (kN) <sup>4</sup>
3/4	Within 1 inch of opposite wall surface	13 (330)	1200 (5.3)	1,000 (4.4)

- 1 Allowable load values are applicable only to anchors where in-place shear tests indicate minimum mortar strength of 50 psi.
- 2 Allowable loads are computed in accordance with ICC-ES AC60 (2010) and IBC (2009).
- 3 No increase for short-term loading is permitted, such as loading induced by wind or earthquake.
- 4 Anchors must be tested in accordance with the requirements of IEBC and UCBC

HIT-HY 270 adhesive with Hilti HAS threaded rods

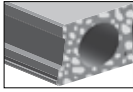
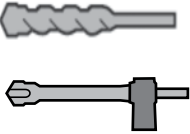

Hilti HAS threaded rod

Permissible Base Materials		Hollow core concrete	Permissible drilling method		Rotary only drilling with carbide tipped drill bit Hilti TE-CD or TE-YD Hollow Drill Bit
----------------------------	---	----------------------	-----------------------------	--	---

**Table 17 - Hilti HIT-HY 270 allowable adhesive bond loads for threaded rods in hollow core concrete panels<sup>1,4,5,6,7</sup>**

Nominal anchor diameter in.	Effective embedment in. (mm) <sup>2</sup>	Minimum concrete thickness in. (mm) <sup>3</sup>	Tension lb (kN)	Shear lb (kN)
3/8	2 (50.8)	1-3/8 (34.9)	450 (2.0)	560 (2.5)

- 1 All values are for anchor installed in hollow core concrete with minimum compressive strength of 7,000 psi. Due to variations in materials and dimensional configurations, on-site testing is required to determine the actual performance of the anchor. Allowable loads are calculated using a safety factor of 5.
- 2 Tabulated embedment depth is limited by the plastic HIT-SC 16x50 mm screens. See figure 12.
- 3 The required concrete thickness is the thickness for which values are available and installation is recommended. Anchors shall be installed along the centerline of the hollow core or along the line of minimum thickness. Verify these requirements with the hollow core plank supplier before installation. The required thickness is measured from the inner to the outer side of hollow core panel. See figure 12.
- 4 Tabulated allowable loads must be the lesser of the adjusted bond values tabulated and the steel values in table 3.
- 5 Allowable loads shall be adjusted for increased base material temperature in accordance with Figure 13.
- 6 The adhesive gel and cure times shall be identical to the values adopted for masonry.
- 7 For combined loading:  $(T_{\text{applied}} / T_{\text{allowable}}) + (V_{\text{applied}} / V_{\text{allowable}}) \leq 1$

**Figure 12 – Hilti HIT-HY 270 adhesive installed in hollow core concrete<sup>1,2</sup>**

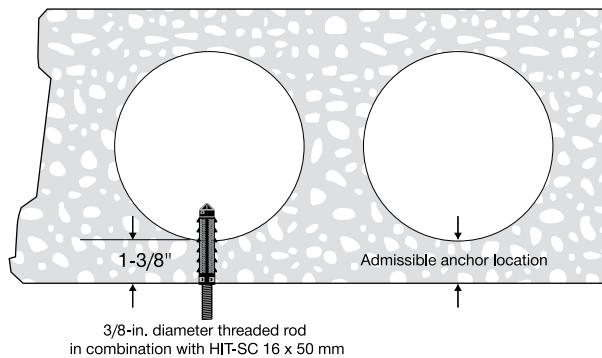

- 1 Representation of the tested conditions for which allowable adhesive bond loads are applicable. Refer to footnote 3 of corresponding load table above for more information on requirements and restrictions on the admissible anchor installation.
- 2 Minimum edge distance is 6-inches. Minimum spacing is:
  - 8-inches along the length of each hollow core section.
  - One anchor per hollow core section (left and right on page), 6-inches minimum between adjacent hollow core sections.

3.2.5

## INSTALLATION INSTRUCTIONS

Installation Instructions For Use (IFU) are included with each product package. They can also be viewed or downloaded online at [www.hilti.com](http://www.hilti.com). Because of the possibility of changes, always verify that downloaded IFU are current when used. Proper installation is critical to achieve full performance. Training is available on request. Contact Hilti Technical Services for applications and conditions not addressed in the IFU.

## MATERIAL SPECIFICATIONS

**Table 1 - Properties of fully-cured HIT-HY 270 adhesive**

Compressive strength	ASTM D695/DIN 53454	7,252-10,153 psi	50-70
Modulus of elasticity (Compression test)	ASTM D790/DIN 53452	246,568 psi	1,700 MPa
Water absorption	ASTM D570/DIN 53495	3 - 8%	
Electrical resistance	VDE/DIN 0303T3	4.2 x 10 <sup>11</sup> ohm/in.	1.065 x 10 <sup>12</sup> ohm/cm

Material specifications for Hilti HAS threaded rods and Hilti HIS-N inserts are listed in section 3.2.8.

**Figure 13 — Influence of in-service temperature on bond loads**

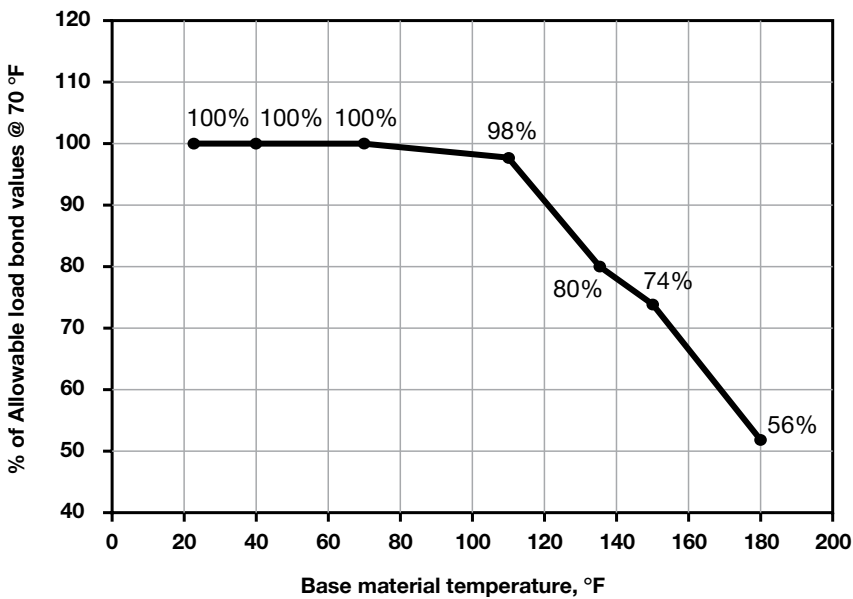

ORDERING INFORMATION

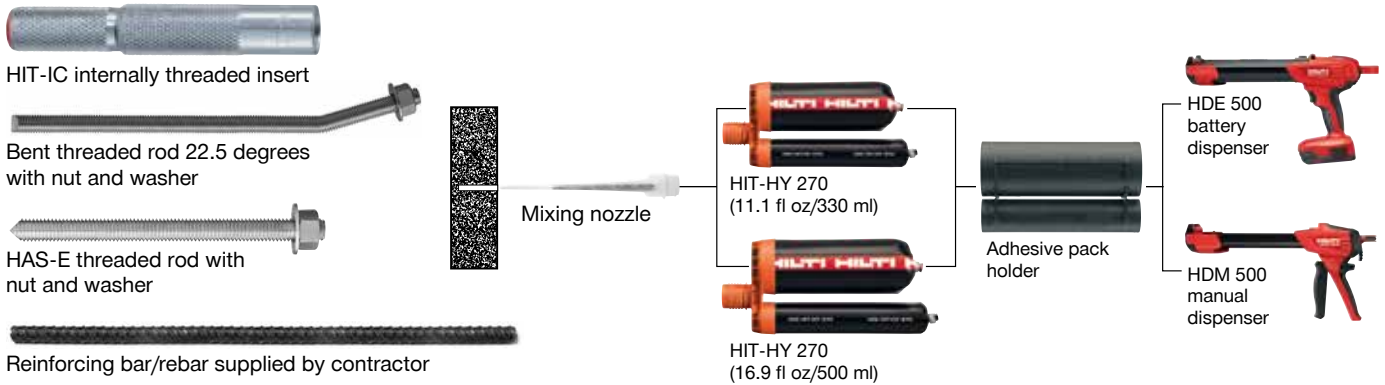

Description	Package Contents	Qty of Foil Packs
HIT-HY 270 (11.1OZ/330ML)	Includes (1) foil pack with (1) mixer and 3/8-in. filler tuber per pack	1
HIT-HY 270 (11.1OZ/330ML) 1 MC	Includes (1) master carton containing (25) foil packs with (1) mixer and 3/8-in. filler tuber per pack	25
HIT-HY 270 (16.9OZ/500ML) 1 MC	Includes (1) master carton containing (20) foil packs with (1) mixer and 3/8-in. filler tuber per pack	20
HIT-HY 270/500ML (2MC)+ HDM 500	Includes (2) master cartons containing (20) foil packs each with (1) mixer and 3/8-in. filler tuber per pack and (1) HDM 500 manual dispenser	40
HIT-HY 270/500ML (2MC)+ HDE 500 KIT	Includes (2) master cartons containing (20) foil packs each with (1) mixer and 3/8-in. filler tuber per pack and (1) HDM 500 manual dispenser	40
HY 270 TE 30-C AVR SAFESET PACK	Includes TE 30-C AVR, VC 150 6-X, (40) HIT-HY 270 500/1, HDE 500-A22, C 4/36 LI-ION, (1) B 22/2.6 LI-ION, HIT-CB 500, TE-CD BITS: (1) 1/2"-13", (1) 9/16"-14", (1) 5/8"-14", (1) 3/4"-14", & BAG SMALL	40
HY 270 TE 6-A22 SAFESET PACK	Includes TE 6-A22, VC 150 6-X, (40) HIT-HY 270 500/1, HDE 500-A22, C 4/36 LI-ION, (2) B 22/5.2 LI-ION, HIT-CB 500, TE-CD BITS: (1) 1/2"-13", (1) 9/16"-14", (1) 5/8"-14", (1) 3/4"-14", & BAG SMALL	40
HY 270 TE 30-A36 SAFESET PACK	Includes TE 30-A36, VC 150 6-X, (40) HIT-HY 270 500/1, HDE 500-A22, C 4/36-350 LI-ION, (2) B 36/6.0 LI-ION, HIT-CB 500, TE-CD BITS: (1) 1/2"-13", (1) 9/16"-14", (1) 5/8"-14", (1) 3/4"-14", & BAG SMALL	40
HIT-RE-M Static Mixer	For use with HIT-HY 270 cartridges	1

Customize the sleeve to the length of your application. Different embedment depths are created with minimal effort.

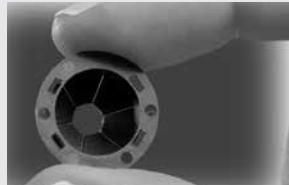

Step 1: Remove the centering ring of any screen tube within the cell.



Step 2: Pierce the tip of the screen tube with the rod intended to be used to check embedment depth.



Step 3: Combine screen tubes to desired length.

3.2.5

Brick with holes and hollow concrete block

Threaded Rod			Mesh Sleeve		Approximate fastenings per foil pack <sup>1</sup>	
			Nominal Bit Dia., in.	Mesh Sleeve per Fastening	11.1 fl oz (330 ml)	16.9 fl oz (500 ml)
Plastic Sleeve (for #14 screw)	Embedment, in.	Qty	1/2	(1) HIT S-12/I	25	40
HAS B 1/4 x 3	2	20	1/2	(1) SC 12x50	25	40
HAS B 1/4 x 4-1/2	3-1/8	20	1/2	(1) SC 12x85	16	26
HAS B 5/16 x 3	2	20	5/8	(1) SC 16x50	16	26
HAS B 5/16 x 4-1/2	3-1/8	20	5/8	(1) SC 16x85	7	12
HAS-E 3/8 x 3	2	10	5/8	(1) SC 16x50	16	26
HAS-E 3/8 x 4-3/8	3-1/8	10	5/8	(1) SC 16x85	7	12
HAS-E 1/2 x 3-1/8	2	10	11/16	(1) SC 18x50	9	15
HAS-E 1/2 x 4-1/2	3-1/8	10	11/16	(1) SC 18x85	4	7

## Composite mesh sleeves for hollow masonry and brick material

Description	For use with:	Qty	Actual Dia., in.	Length, in.	Bit Dia.
Mesh sleeve HIT-SC 12x50 ①	1/4 dia. rods	20	0.47	1.97	1/2
Mesh sleeve HIT-SC 12x85 ①	1/4 dia. rods	20	0.47	3.35	1/2
Mesh sleeve HIT-SC 16x50 ①	5/16, 3/8 dia. rods and 5/16 HIT-IC rods	20	0.63	1.97	5/8
Mesh sleeve HIT-SC 16x85 ①	5/16, 3/8 dia. rods and 5/16 HIT-IC rods	20	0.63	3.35	5/8
Mesh sleeve HIT-SC 18x50 ①	1/2 dia. rods	20	0.71	1.97	11/16
Mesh sleeve HIT-SC 18x85 ①	1/2 dia. rods	20	0.71	3.35	11/16
Mesh sleeve HIT-SC 22x50 ①	5/8 dia. rods, 3/8 and 1/2 HIT-IC rods	20	0.87	1.97	7/8
Mesh sleeve HIT-SC 22x85 ①	5/8 dia. rods, 3/8 and 1/2 HIT-IC rods	10	0.87	3.35	7/8
Mesh sleeve HIT-SC 26x125 ②	3/4 dia. rods	20	1.02	4.92	1
Mesh sleeve HIT-SC 26x200 ②	3/4 dia. rods	20	1.02	7.87	1

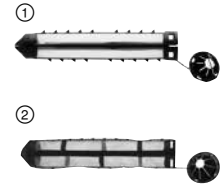

## Internally threaded inserts for hollow masonry and brick material

Description	For use with:	Qty	Bit Dia., in.	Threads per inch
Internally Threaded HIT-IC 5/16 x 2	In hollow material use with HIT-SC 16 x 50	10	5/8	18
Internally Threaded HIT-IC 5/16 x 3-3/16 ③	In hollow material use with HIT-SC 16 x 85	10	5/8	18
Internally Threaded HIT-IC 3/8 x 2	In hollow material use with HIT-SC 22 x 50	10	7/8	16
Internally Threaded HIT-IC 3/8 x 3-3/16 ③	In hollow material use with HIT-SC 22 x 85	10	7/8	16
Internally Threaded HIT-IC 1/2 x 2	In hollow material use with HIT-SC 22 x 50	10	7/8	13
Internally Threaded HIT-IC 1/2 3 x 3/16 ③	In hollow material use with HIT-SC 22 x 85	10	7/8	13
HIT Combi-Insert HIT-S - 12/I ④	Plastic sleeve for #14 screw	20	1/2	-

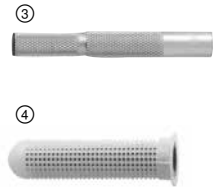

## Multi-wythe brick walls

Threaded Rod		Mesh Sleeve		Approximate fastenings per foil pack <sup>1</sup>		
Rod Size 5.8 Grade	Embedment, in.	Qty	Bit Diameter, in.	Mesh Sleeve per Fastening	11.1 fl oz (330 ml)	16.9 fl oz (500 ml)
HAS-E 3/8 x 5-1/8	4	20	5/8	(2) SC 16x50	15	24
HAS-E 3/8 x 8	6-3/4	10	5/8	(2) SC 16x85	9	14
HAS-E 3/8 x 12	10	10	5/8	(3) SC 16x85	5	9
HAS-E 1/2 x 8	6-3/4	10	11/16	(2) SC 18x85	7	11
HAS-E 1/2 x 12	10	10	11/16	(3) SC 18x85	4	7
HAS-E 5/8 x 8	6-3/4	20	7/8	(2) SC 22x85	4	7
HAS-E 5/8 x 12	10	10	7/8	(3) SC 22x85	2	4
HAS-E 3/4 x 10	8	10	1	(1) SC 26x200	2	4
HAS-E 3/4 x 14	13	10	1	(1) SC 26x200, (1) SC 26x125	1	2
HAS-E 3/4 x 17	15-3/4	10	1	(2) SC 26x200	1	2
HAS-E 3/4 x 19	18	10	1	(2) SC 26x125, (1) SC 26 x 200	1	2
HAS-E 3/4 x 25	23-1/2	10	1	(3) SC 26x200	0	1

## Internally threaded inserts

Threaded Rod		Mesh Sleeve		Approximate fastenings per foil pack <sup>1</sup>		
Rod Size 5.8 Grade	Embedment, in.	Qty	Bit Diameter, in.	Mesh Sleeve per Fastening	11.1 fl oz (330 ml)	16.9 fl oz (500 ml)
Internally Threaded HIT-IC 5/16 x 2	2	10	5/8	(1) SC 16x50	16	26
Internally Threaded HIT-IC 5/16 x 3-3/16	3-1/4	10	5/8	(1) SC 16x85	7	12
Internally Threaded HIT-IC 3/8 x 2	2	10	7/8	(1) SC 22x50	9	15
Internally Threaded HIT-IC 3/8 x 3-3/16	3-1/4	10	7/8	(1) SC 22x85	4	7
Internally Threaded HIT-IC 1/2 x 2	2	10	7/8	(1) SC 22x50	9	15
Internally Threaded HIT-IC 1/2 3-3/16	3-1/4	10	7/8	(1) SC 22x85	4	7

<sup>1</sup> Assumes use with HDM 500 Manual Dispenser

## Cleaning accessories

Hole Diameter	Round Brush Size use with HIT-RBH handle	Qty
1/2	HIT-RB 1/2	1
5/8	HIT-RB 5/8	1
11/16	HIT-RB 11/16	1
7/8	HIT-RB 7/8	1
1	HIT-RB 1	1

