



The following excerpt are pages from the North American Product Technical Guide, Volume 2: Anchor Fastening, Edition 19.

Please refer to the publication in its entirety for complete details on this product including data development, product specifications, general suitability, installation, corrosion and spacing and edge distance guidelines.

US&CA: <https://submittals.us.hilti.com/PTGVol2/>

To consult directly with a team member regarding our anchor fastening products, contact Hilti's team of technical support specialists between the hours of 7:00am – 6:00pm CST.

US: 877-749-6337 or HNATechnicalServices@hilti.com

CA: 1-800-363-4458, ext. 6 or CATechnicalServices@hilti.com

1/2" diameter anchor data for CIP is bubbled for convenience

*CIP See Pages 112,141-144

3.2.3 HIT-RE 500 V3 EPOXY ADHESIVE ANCHORING SYSTEM

PRODUCT DESCRIPTION

HIT-RE 500 V3 with Threaded Rod, Rebar, and HIS-N/RN Inserts

Anchor System	Features and Benefits
 <p>Hilti HIT-RE 500 V3 Cartridge</p>	<ul style="list-style-type: none"> • Superior bond performance in both cracked and uncracked concrete • Seismic qualified in accordance with ICC-ES Acceptance Criteria AC308 and ACI 355.4 • No hole cleaning requirement when installed SafeSet™ hollow drill bit technology • ICC-ES approved for cracked concrete and seismic service
 <p>Hilti HAS Threaded Rods</p>	<ul style="list-style-type: none"> • May be installed in diamond cored holes in cracked and uncracked concrete including all seismic zones concrete using the Safe-Set™ system using the TE-YRT Roughening tool
 <p>Rebar</p>	<ul style="list-style-type: none"> • Use underwater up to 165 ft (50 m) • Meets requirements of ASTM C881-14, Type I, II, IV, and V, Grade 3, Class A, B, and C.
 <p>Hilti HIS-N</p>	<ul style="list-style-type: none"> • Meets requirements of AASHTO specification M235, Type I, II, IV, and V, Grade 3, Class A, B, and C • Technical data available for larger diameters, oversized holes, deeper embedments. Contact Hilti Technical Services for additional information

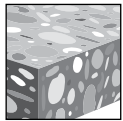

Uncracked concrete

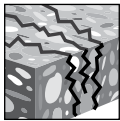

Cracked concrete

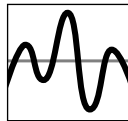

Seismic design categories A-F

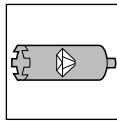

Diamond cored holes for cracked and uncracked concrete



Hollow drill bit Roughening tool



Profis anchor design software

Approvals/Listings	
ICC-ES (International Code Council)	ESR-3814 in concrete per ACI 318-14 Ch. 17 / ACI 355.2/ ICC-ES AC308 ELC-3814 in concrete per CSA A23.3-14 / ACI 355.2
NSF/ANSI Std 61	Certification for use in potable water
European Technical Approval	ETA-16/0142, ETA-16/0143, ETA-16/0180
City of Los Angeles	City of Los Angeles 2017 LABC Supplement (within ESR-3814)
Florida Building Code	2017 FBC Supplement (within ESR-1814)
U.S. Green Building Council	LEED® Credit 4.1-Low Emitting Materials
Department of Transportation	Contact Hilti for various states



MATERIAL SPECIFICATIONS

Table 1 - Material properties of fully cured Hilti HIT-RE 500 V3

Bond Strength ASTM C882-13A ¹ 2 day cure 14 day cure	10.8 MPa 11.7 MPa	1,560 psi 1,690 psi
Compressive Strength ASTM D695-10 ¹	82.7 MPa	12,000 psi
Compressive Modulus ASTM D695-10 ¹	2,600 MPa	0.38 x 10 ⁶ psi
Tensile Strength 7 day ASTM D638-14	49.3 MPa	7,150 psi
Elongation at break ASTM D638-14	1.1%	1.1%
Heat Deflection Temperature ASTM D648-07	50°C	122°F
Absorption ASTM D570-98	0.18%	0.18%
Linear Coefficient of Shrinkage on Cure ASTM D2566-86	0.008	0.008

¹ Minimum values obtained as the result of tests at 35°F, 50°F, 75°F and 110°F.

Material specifications for Hilti threaded rods and Hilti HIS-N inserts are listed in section 3.2.8.

DESIGN DATA IN CONCRETE FOR ACI 318

ACI 318-14 Chapter 17 design

The load values contained in this section are Hilti Simplified Design Tables. The load tables in this section were developed using the strength design parameters and variables of ESR-3814 and the equations within ACI 318-14 Chapter 17. For a detailed explanation of the Hilti Simplified Design Tables, refer to Section 3.1.8. Data tables from ESR-3814 are not contained in this section, but can be found at www.icc-es.org or at www.hilti.com.

3.2.3

HIT-RE 500 V3 adhesive with deformed reinforcing bars (rebar)



Figure 1 - Rebar installed with Hilti HIT-RE 500 V3 adhesive











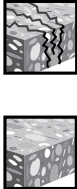

Cracked or uncracked concrete	Permissible drilling methods	Permissible concrete conditions
 <p>Cracked and uncracked concrete</p>	 <p>Hammer drilling with carbide-tipped drill bit</p>	 Dry concrete  Water-saturated concrete  Water-filled holes  Submerged (underwater)
	  <p>Hilti TE-CD or TE-YD hollow drill bit and VC 20/40 vacuum Diamond core drill bit with Hilti TE-YRT roughening tool</p>	 Dry concrete  Water-saturated concrete
 <p>Uncracked concrete</p>	 <p>Diamond core drill bit</p>	 Dry concrete  Water-saturated concrete

Figure 2 - Rebar installed with Hilti HIT-RE 500 V3 adhesive

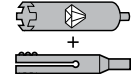
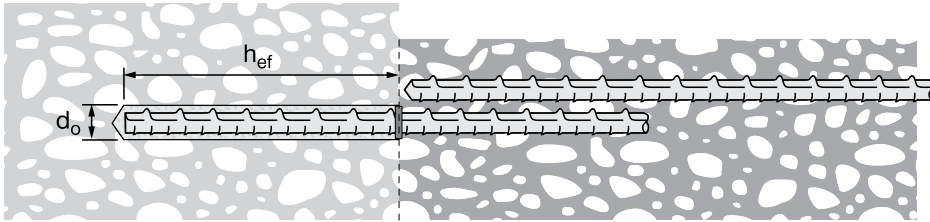

Table 2 - Specifications for rebar installed with Hilti HIT-RE 500 V3 adhesive

Setting information		Symbol	Units	Rebar size							
				#3	#4	#5	#6	#7	#8	#9	#10
Nominal bit diameter		d_o	in.	1/2	5/8	3/4	7/8	1	1-1/8	1-3/8	1-1/2
Effective embedment	minimum	$h_{ef,min}$	in. (mm)	2-3/8 (60)	2-3/8 (60)	3 (76)	3 (76)	3-3/8 (85)	4 (102)	4-1/2 (114)	5 (127)
	maximum	$h_{ef,max}$	in. (mm)	7-1/2 (191)	10 (254)	12-1/2 (318)	15 (381)	17-1/2 (445)	20 (508)	22-1/2 (572)	25 (635)
Minimum concrete member thickness		h_{min}	in. (mm)	$h_{ef} + 1-1/4$ ($h_{ef} + 30$)			$(h_{ef} + 2d_o)$				
Minimum edge distance ¹		c_{min}	in. (mm)	1-7/8 (48)	2-1/2 (64)	3-1/8 (79)	3-3/4 (95)	4-3/8 (111)	5 (127)	5-5/8 (143)	6-1/4 (159)
Minimum anchor spacing		s_{min}	in. (mm)	1-7/8 (48)	2-1/2 (64)	3-1/8 (79)	3-3/4 (95)	4-3/8 (111)	5 (127)	5-5/8 (143)	6-1/4 (159)

¹ Edge distance of 1-3/4-inch (44mm) is permitted provided the rebar remains un-torqued.

Note: The installation specifications in table 2 above and the data in tables 3 through 23 pertain to the use of Hilti HIT-RE 500 V3 with rebar designed as a post-installed anchor using the provisions of ACI 318-14 Chapter 17. For the use of Hilti HIT-RE 500 V3 with rebar for typical development calculations according to ACI 318-14 Chapter 25 (formerly ACI 318-11 Chapter 12), refer to section 3.1.14 for the design method and tables 83 through 87 in section 3.2.4.3.8.

Table 3 - Hilti HIT-RE 500 V3 adhesive design strength with concrete / bond failure for US rebar in uncracked concrete 1,2,3,4,5,6,7,8,9,11

Rebar size	Effective embedment in. (mm)	Tension — ϕN_n				Shear — ϕV_n			
		$f'_c = 2,500$ psi (17.2 MPa) lb (kN)	$f'_c = 3,000$ psi (20.7 MPa) lb (kN)	$f'_c = 4,000$ psi (27.6 MPa) lb (kN)	$f'_c = 6,000$ psi (41.4 MPa) lb (kN)	$f'_c = 2,500$ psi (17.2 MPa) lb (kN)	$f'_c = 3,000$ psi (20.7 MPa) lb (kN)	$f'_c = 4,000$ psi (27.6 MPa) lb (kN)	$f'_c = 6,000$ psi (41.4 MPa) lb (kN)
#3	3-3/8 (86)	4,575 (20.4)	4,790 (21.3)	5,145 (22.9)	5,695 (25.3)	9,855 (43.8)	10,310 (45.9)	11,080 (49.3)	12,265 (54.6)
	4-1/2 (114)	6,100 (27.1)	6,385 (28.4)	6,860 (30.5)	7,590 (33.8)	13,135 (58.4)	13,750 (61.2)	14,775 (65.7)	16,350 (72.7)
	7-1/2 (191)	10,165 (45.2)	10,640 (47.3)	11,435 (50.9)	12,655 (56.3)	21,895 (97.4)	22,915 (101.9)	24,625 (109.5)	27,250 (121.2)
#4	4-1/2 (114)	7,445 (33.1)	8,155 (36.3)	8,990 (40.0)	9,950 (44.3)	16,035 (71.3)	17,570 (78.2)	19,365 (86.1)	21,430 (95.3)
	6 (152)	10,660 (47.4)	11,155 (49.6)	11,990 (53.3)	13,265 (59.0)	22,960 (102.1)	24,030 (106.9)	25,820 (114.9)	28,575 (127.1)
	10 (254)	17,765 (79.0)	18,595 (82.7)	19,980 (88.9)	22,110 (98.3)	38,265 (170.2)	40,050 (178.2)	43,035 (191.4)	47,625 (211.8)
#5 ¹⁰	5-5/8 (143)	10,405 (46.3)	11,400 (50.7)	13,165 (58.6)	15,370 (68.4)	22,415 (99.7)	24,550 (109.2)	28,350 (126.1)	33,105 (147.3)
	7-1/2 (191)	16,020 (71.3)	17,230 (76.6)	18,515 (82.4)	20,490 (91.1)	34,505 (153.5)	37,115 (165.1)	39,880 (177.4)	44,135 (196.3)
	12-1/2 (318)	27,440 (122.1)	28,720 (127.8)	30,860 (137.3)	34,155 (151.9)	59,100 (262.9)	61,855 (275.1)	66,470 (295.7)	73,560 (327.2)
#6 ¹⁰	6-3/4 (171)	13,680 (60.9)	14,985 (66.7)	17,305 (77.0)	21,190 (94.3)	29,460 (131.0)	32,275 (143.6)	37,265 (165.8)	45,645 (203.0)
	9 (229)	21,060 (93.7)	23,070 (102.6)	26,200 (116.5)	28,995 (129.0)	45,360 (201.8)	49,690 (221.0)	56,430 (251.0)	62,450 (277.8)
	15 (381)	38,825 (172.7)	40,635 (180.8)	43,665 (194.2)	48,325 (215.0)	83,620 (372.0)	87,520 (389.3)	94,045 (418.3)	104,080 (463.0)
#7 ¹⁰	7-7/8 (200)	17,235 (76.7)	18,885 (84.0)	21,805 (97.0)	26,705 (118.8)	37,125 (165.1)	40,670 (180.9)	46,960 (208.9)	57,515 (255.8)
	10-1/2 (267)	26,540 (118.1)	29,070 (129.3)	33,570 (149.3)	38,995 (173.5)	57,160 (254.3)	62,615 (278.5)	72,300 (321.6)	83,995 (373.6)
	17-1/2 (445)	52,220 (232.3)	54,655 (243.1)	58,730 (261.2)	64,995 (289.1)	112,470 (500.3)	117,715 (523.6)	126,495 (562.7)	139,990 (622.7)
#8 ¹⁰	9 (229)	21,060 (93.7)	23,070 (102.6)	26,640 (118.5)	32,625 (145.1)	45,360 (201.8)	49,690 (221.0)	57,375 (255.2)	70,270 (312.6)
	12 (305)	32,425 (144.2)	35,520 (158.0)	41,015 (182.4)	50,020 (222.5)	69,835 (310.6)	76,500 (340.3)	88,335 (392.9)	107,735 (479.2)
	20 (508)	66,980 (297.9)	70,100 (311.8)	75,330 (335.1)	83,365 (370.8)	144,260 (641.7)	150,990 (671.6)	162,250 (721.7)	179,560 (798.7)
#9 ¹⁰	10-1/8 (257)	25,130 (111.8)	27,530 (122.5)	31,785 (141.4)	38,930 (173.2)	54,125 (240.8)	59,290 (263.7)	68,465 (304.5)	83,850 (373.0)
	13-1/2 (343)	38,690 (172.1)	42,380 (188.5)	48,940 (217.7)	59,940 (266.6)	83,330 (370.7)	91,285 (406.1)	105,405 (468.9)	129,095 (574.2)
	22-1/2 (572)	83,245 (370.3)	87,640 (389.8)	94,175 (418.9)	104,225 (463.6)	179,300 (797.6)	188,765 (839.7)	202,840 (902.3)	224,480 (998.5)
#10	11-1/4 (286)	29,430 (130.9)	32,240 (143.4)	37,230 (165.6)	45,595 (202.8)	63,395 (282.0)	69,445 (308.9)	80,185 (356.7)	98,205 (436.8)
	15 (381)	45,315 (201.6)	49,640 (220.8)	57,320 (255.0)	70,200 (312.3)	97,600 (434.1)	106,915 (475.6)	123,455 (549.2)	151,200 (672.6)
	25 (635)	97,500 (433.7)	106,195 (472.4)	114,115 (507.6)	126,290 (561.8)	210,000 (934.1)	228,730 (1017.4)	245,785 (1093.3)	272,005 (1209.9)

3.2.3

- See Section 3.1.8 for explanation on development of load values.
- See Section 3.1.8 to convert design strength value to ASD value.
- Linear interpolation between embedment depths and concrete compressive strengths is not permitted.
- Apply spacing, edge distance, and concrete thickness factors in tables 8-23 as necessary to the above values. Compare to the steel values in table 7. The lesser of the values is to be used for the design.
- Data is for temperature range A: Max. short term temperature = 130°F (55°C), max. long term temperature = 110°F (43°C). For temperature range B: Max. short term temperature = 176°F (80°C), max. long term temperature = 110°F (43°C) multiply above values by 0.69. Short term elevated concrete temperatures are those that occur over brief intervals, e.g., as a result of diurnal cycling. Long term concrete temperatures are roughly constant over significant periods of time.
- Tabular values are for dry concrete and water-saturated concrete conditions. For water-filled drilled holes multiply design strength by 0.51. For submerged (under water) applications multiply design strength by 0.45.
- Tabular values are for short term loads only. For sustained loads including overhead use, see Section 3.1.8.
- Tabular values are for normal-weight concrete only. For lightweight concrete multiply design strength by λ_a as follows: For sand-lightweight, $\lambda_a = 0.51$. For all-lightweight, $\lambda_a = 0.45$.
- Tabular values are for holes drilled in concrete with carbide tipped hammer drill bit. For diamond core drilling, except as indicated in note 10, multiply above values by 0.55. Diamond core drilling is not permitted for the water-filled or under-water (submerged) applications.
- Diamond core drilling with the Hilti TE-YRT roughening tool is permitted for #5, #6, #7, #8, and #9 rebar in dry and water-saturated concrete. See Table 5
- Tabular values are for static loads only. Seismic design is not permitted for uncracked concrete.

Table 4 - Hilti HIT-RE 500 V3 adhesive design strength with concrete / bond failure for US rebar in cracked concrete^{1,2,3,4,5,6,7,8,9,11}

Rebar size	Effective embedment in. (mm)	Tension — ϕN_n				Shear — ϕV_n			
		$f'_c = 2,500$ psi (17.2 MPa) lb (kN)	$f'_c = 3,000$ psi (20.7 MPa) lb (kN)	$f'_c = 4,000$ psi (27.6 MPa) lb (kN)	$f'_c = 6,000$ psi (41.4 MPa) lb (kN)	$f'_c = 2,500$ psi (17.2 MPa) lb (kN)	$f'_c = 3,000$ psi (20.7 MPa) lb (kN)	$f'_c = 4,000$ psi (27.6 MPa) lb (kN)	$f'_c = 6,000$ psi (41.4 MPa) lb (kN)
#3	3-3/8 (86)	3,425 (15.2)	3,585 (15.9)	3,745 (16.7)	3,980 (17.7)	7,380 (32.8)	7,725 (34.4)	8,065 (35.9)	8,570 (38.1)
	4-1/2 (114)	4,650 (20.7)	4,780 (21.3)	4,990 (22.2)	5,305 (23.6)	10,020 (44.6)	10,300 (45.8)	10,750 (47.8)	11,425 (50.8)
	7-1/2 (191)	7,755 (34.5)	7,970 (35.5)	8,320 (37.0)	8,840 (39.3)	16,700 (74.3)	17,165 (76.4)	17,920 (79.7)	19,045 (84.7)
#4	4-1/2 (114)	5,275 (23.5)	5,780 (25.7)	6,670 (29.7)	7,125 (31.7)	11,360 (50.5)	12,445 (55.4)	14,370 (63.9)	15,345 (68.3)
	6 (152)	8,120 (36.1)	8,560 (38.1)	8,940 (39.8)	9,500 (42.3)	17,490 (77.8)	18,440 (82.0)	19,255 (85.7)	20,465 (91.0)
	10 (254)	13,885 (61.8)	14,270 (63.5)	14,900 (66.3)	15,835 (70.4)	29,910 (133.0)	30,735 (136.7)	32,095 (142.8)	34,105 (151.7)
#5 ¹⁰	5-5/8 (143)	7,370 (32.8)	8,075 (35.9)	9,325 (41.5)	11,380 (50.6)	15,875 (70.6)	17,390 (77.4)	20,080 (89.3)	24,510 (109.0)
	7-1/2 (191)	11,350 (50.5)	12,430 (55.3)	14,275 (63.5)	15,170 (67.5)	24,440 (108.7)	26,775 (119.1)	30,750 (136.8)	32,680 (145.4)
	12-1/2 (318)	22,175 (98.6)	22,790 (101.4)	23,795 (105.8)	25,285 (112.5)	47,760 (212.4)	49,085 (218.3)	51,250 (228.0)	54,465 (242.3)
#6 ¹⁰	6-3/4 (171)	9,690 (43.1)	10,615 (47.2)	12,255 (54.5)	15,010 (66.8)	20,870 (92.8)	22,860 (101.7)	26,395 (117.4)	32,330 (143.8)
	9 (229)	14,920 (66.4)	16,340 (72.7)	18,870 (83.9)	22,160 (98.6)	32,130 (142.9)	35,195 (156.6)	40,640 (180.8)	47,735 (212.3)
	15 (381)	32,095 (142.8)	33,290 (148.1)	34,760 (154.6)	36,935 (164.3)	69,135 (307.5)	71,700 (318.9)	74,865 (333.0)	79,560 (353.9)
#7 ¹⁰	7-7/8 (200)	12,210 (54.3)	13,375 (59.5)	15,445 (68.7)	18,915 (84.1)	26,300 (117.0)	28,810 (128.2)	33,265 (148.0)	40,740 (181.2)
	10-1/2 (267)	18,800 (83.6)	20,590 (91.6)	23,780 (105.8)	29,120 (129.5)	40,490 (180.1)	44,355 (197.3)	51,215 (227.8)	62,725 (279.0)
	17-1/2 (445)	40,445 (179.9)	44,310 (197.1)	47,310 (210.4)	50,275 (223.6)	87,115 (387.5)	95,430 (424.5)	101,895 (453.2)	108,285 (481.7)
#8 ¹⁰	9 (229)	14,920 (66.4)	16,340 (72.7)	18,870 (83.9)	23,110 (102.8)	32,130 (142.9)	35,195 (156.6)	40,640 (180.8)	49,775 (221.4)
	12 (305)	22,965 (102.2)	25,160 (111.9)	29,050 (129.2)	35,580 (158.3)	49,465 (220.0)	54,190 (241.0)	62,570 (278.3)	76,635 (340.9)
	20 (508)	49,415 (219.8)	54,135 (240.8)	62,230 (276.8)	66,130 (294.2)	106,435 (473.4)	116,595 (518.6)	134,035 (596.2)	142,440 (633.6)
#9 ¹⁰	10-1/8 (257)	17,800 (79.2)	19,500 (86.7)	22,515 (100.2)	27,575 (122.7)	38,340 (170.5)	42,000 (186.8)	48,495 (215.7)	59,395 (264.2)
	13-1/2 (343)	27,405 (121.9)	30,020 (133.5)	34,665 (154.2)	42,455 (188.8)	59,025 (262.6)	64,660 (287.6)	74,665 (332.1)	91,445 (406.8)
	22-1/2 (572)	58,965 (262.3)	64,595 (287.3)	74,585 (331.8)	81,930 (364.4)	127,005 (564.9)	139,125 (618.9)	160,650 (714.6)	176,465 (785.0)
#10	11-1/4 (286)	20,850 (92.7)	22,840 (101.6)	26,370 (117.3)	32,295 (143.7)	44,905 (199.7)	49,190 (218.8)	56,800 (252.7)	69,565 (309.4)
	15 (381)	32,095 (142.8)	35,160 (156.4)	40,600 (180.6)	49,725 (221.2)	69,135 (307.5)	75,730 (336.9)	87,445 (389.0)	107,100 (476.4)
	25 (635)	69,060 (307.2)	75,655 (336.5)	87,360 (388.6)	97,510 (433.7)	148,750 (661.7)	162,945 (724.8)	188,155 (837.0)	210,020 (934.2)

- See Section 3.1.8 for explanation on development of load values.
- See Section 3.1.8 to convert design strength value to ASD value.
- Linear interpolation between embedment depths and concrete compressive strengths is not permitted.
- Apply spacing, edge distance, and concrete thickness factors in tables 8-23 as necessary to the above values. Compare to the steel values in table 7. The lesser of the values is to be used for the design.
- Data is for temperature range A: Max. short term temperature = 130°F (55°C), max. long term temperature = 110°F (43°C). For temperature range B: Max. short term temperature = 176°F (80°C), max. long term temperature = 110°F (43°C) multiply above values by 0.69. Short term elevated concrete temperatures are those that occur over brief intervals, e.g., as a result of diurnal cycling. Long term concrete temperatures are roughly constant over significant periods of time.
- Tabular values are for dry concrete and water-saturated concrete conditions. For water-filled drilled holes multiply design strength by 0.51. For submerged (under water) applications multiply design strength by 0.45.
- Tabular values are for short term loads only. For sustained loads including overhead use, see Section 3.1.8.
- Tabular values are for normal-weight concrete only. For lightweight concrete multiply design strength by λ_a as follows: For sand-lightweight, $\lambda_a = 0.51$. For all-lightweight, $\lambda_a = 0.45$.
- Tabular values are for holes drilled in concrete with carbide tipped hammer drill bit. Diamond core drilling is not permitted in cracked concrete except as indicated in note 10.
- Diamond core drilling with the Hilti TE-YRT roughening tool is permitted for #5, #6, #7, #8, and #9 rebar in dry and water-saturated concrete. See Table 6
- Tabular values are for static loads only. For seismic loads, multiply cracked concrete tabular values in tension and shear by $\alpha_{seis} = 0.68$. See section 3.1.8 for additional information on seismic applications.

Table 5 - Hilti HIT-RE 500 V3 for Core Drilled Holes with TE-YRT Roughening Tool adhesive design strength with concrete / bond failure for US rebar in uncracked concrete^{1,2,3,4,5,6,7,8,9}

Rebar size	Effective embedment in. (mm)	Tension — ϕN_n				Shear — ϕV_n			
		$f'_c = 2,500$ psi (17.2 MPa) lb (kN)	$f'_c = 3,000$ psi (20.7 MPa) lb (kN)	$f'_c = 4,000$ psi (27.6 MPa) lb (kN)	$f'_c = 6,000$ psi (41.4 MPa) lb (kN)	$f'_c = 2,500$ psi (17.2 MPa) lb (kN)	$f'_c = 3,000$ psi (20.7 MPa) lb (kN)	$f'_c = 4,000$ psi (27.6 MPa) lb (kN)	$f'_c = 6,000$ psi (41.4 MPa) lb (kN)
#5	5-5/8 (143)	10,405 (46.3)	11,400 (50.7)	12,350 (54.9)	12,350 (54.9)	22,415 (99.7)	24,550 (109.2)	26,595 (118.3)	26,595 (118.3)
	7-1/2 (191)	16,020 (71.3)	16,465 (73.2)	16,465 (73.2)	16,465 (73.2)	34,505 (153.5)	35,460 (157.7)	35,460 (157.7)	35,460 (157.7)
	12-1/2 (318)	27,440 (122.1)	27,440 (122.1)	27,440 (122.1)	27,440 (122.1)	59,100 (262.9)	59,100 (262.9)	59,100 (262.9)	59,100 (262.9)
#6	6-3/4 (171)	13,680 (60.9)	14,985 (66.7)	17,305 (77.0)	17,470 (77.7)	29,460 (131.0)	32,275 (143.6)	37,265 (165.8)	37,630 (167.4)
	9 (229)	21,060 (93.7)	23,070 (102.6)	23,295 (103.6)	23,295 (103.6)	45,360 (201.8)	49,690 (221.0)	50,175 (223.2)	50,175 (223.2)
	11-1/4 (286)	29,120 (129.5)	29,120 (129.5)	29,120 (129.5)	29,120 (129.5)	62,715 (279.0)	62,715 (279.0)	62,715 (279.0)	62,715 (279.0)
#7	7-7/8 (200)	17,235 (76.7)	18,885 (84.0)	21,805 (97.0)	23,500 (104.5)	37,125 (165.1)	40,670 (180.9)	46,960 (208.9)	50,610 (225.1)
	10-1/2 (267)	26,540 (118.1)	29,070 (129.3)	31,330 (139.4)	31,330 (139.4)	57,160 (254.3)	62,615 (278.5)	67,485 (300.2)	67,485 (300.2)
	17-1/2 (445)	52,220 (232.3)	52,220 (232.3)	52,220 (232.3)	52,220 (232.3)	112,470 (500.3)	112,470 (500.3)	112,470 (500.3)	112,470 (500.3)
#8	9 (229)	21,060 (93.7)	23,070 (102.6)	26,640 (118.5)	30,140 (134.1)	45,360 (201.8)	49,690 (221.0)	57,375 (255.2)	64,920 (288.8)
	12 (305)	32,425 (144.2)	35,520 (158.0)	40,185 (178.8)	40,185 (178.8)	69,835 (310.6)	76,500 (340.3)	86,555 (385.0)	86,555 (385.0)
	20 (508)	66,980 (297.9)	66,980 (297.9)	66,980 (297.9)	66,980 (297.9)	144,260 (641.7)	144,260 (641.7)	144,260 (641.7)	144,260 (641.7)
#9	10-1/8 (257)	25,130 (111.8)	27,530 (122.5)	31,785 (141.4)	37,680 (167.6)	54,125 (240.8)	59,290 (263.7)	68,465 (304.5)	81,160 (361.0)
	13-1/2 (343)	38,690 (172.1)	42,380 (188.5)	48,940 (217.7)	50,240 (223.5)	83,330 (370.7)	91,285 (406.1)	105,405 (468.9)	108,215 (481.4)
	22-1/2 (572)	83,245 (370.3)	83,735 (372.5)	83,735 (372.5)	83,735 (372.5)	179,300 (797.6)	180,355 (802.3)	180,355 (802.3)	180,355 (802.3)

3.2.3

- 1 See Section 3.1.8 for explanation on development of load values.
- 2 See Section 3.1.8 to convert design strength value to ASD value.
- 3 Linear interpolation between embedment depths and concrete compressive strengths is not permitted.
- 4 Apply spacing, edge distance, and concrete thickness factors in tables 8 - 23 as necessary to the above values. Compare to the steel values in table 7. The lesser of the values is to be used for the design.
- 5 Data is for temperature range A: Max. short term temperature = 130°F (55°C), max. long term temperature = 110°F (43°C). For temperature range B: Max. short term temperature = 176°F (80°C), max. long term temperature = 110°F (43°C) multiply above values by 0.69. Short term elevated concrete temperatures are those that occur over brief intervals, e.g., as a result of diurnal cycling. Long term concrete temperatures are roughly constant over significant periods of time.
- 6 Tabular values are for dry concrete and water-saturated concrete conditions. Water-filled and submerged (under water) applications are not permitted for this hole preparation method.
- 7 Tabular values are for short term loads only. For sustained loads including overhead use, see Section 3.1.8.
- 8 Tabular values are for normal-weight concrete only. For lightweight concrete multiply design strength by λ_s as follows: For sand-lightweight, $\lambda_s = 0.51$. For all-lightweight, $\lambda_s = 0.45$.
- 9 Tabular values are for static loads only. Seismic design is not permitted for uncracked concrete.

Table 6 - Hilti HIT-RE 500 V3 for Core Drilled Holes with TE-YRT Roughening Tool adhesive design strength with concrete / bond failure for US rebar in cracked concrete^{1,2,3,4,5,6,7,8,9}

Rebar size	Effective embedment in. (mm)	Tension — ϕN_n				Shear — ϕV_n			
		$f'_c = 2,500$ psi (17.2 MPa) lb (kN)	$f'_c = 3,000$ psi (20.7 MPa) lb (kN)	$f'_c = 4,000$ psi (27.6 MPa) lb (kN)	$f'_c = 6,000$ psi (41.4 MPa) lb (kN)	$f'_c = 2,500$ psi (17.2 MPa) lb (kN)	$f'_c = 3,000$ psi (20.7 MPa) lb (kN)	$f'_c = 4,000$ psi (27.6 MPa) lb (kN)	$f'_c = 6,000$ psi (41.4 MPa) lb (kN)
#5	5-5/8 (143)	6,965 (31.0)	6,965 (31.0)	6,965 (31.0)	6,965 (31.0)	15,000 (66.7)	15,000 (66.7)	15,000 (66.7)	15,000 (66.7)
	7-1/2 (191)	9,285 (41.3)	9,285 (41.3)	9,285 (41.3)	9,285 (41.3)	20,000 (89.0)	20,000 (89.0)	20,000 (89.0)	20,000 (89.0)
	12-1/2 (318)	15,475 (68.8)	15,475 (68.8)	15,475 (68.8)	15,475 (68.8)	33,330 (148.3)	33,330 (148.3)	33,330 (148.3)	33,330 (148.3)
#6	6-3/4 (171)	9,690 (43.1)	10,235 (45.5)	10,235 (45.5)	10,235 (45.5)	20,870 (92.8)	22,045 (98.1)	22,045 (98.1)	22,045 (98.1)
	9 (229)	13,645 (60.7)	13,645 (60.7)	13,645 (60.7)	13,645 (60.7)	29,390 (130.7)	29,390 (130.7)	29,390 (130.7)	29,390 (130.7)
	11-1/4 (286)	17,055 (75.9)	17,055 (75.9)	17,055 (75.9)	17,055 (75.9)	36,740 (163.4)	36,740 (163.4)	36,740 (163.4)	36,740 (163.4)
#7	7-7/8 (200)	12,210 (54.3)	13,375 (59.5)	13,930 (62.0)	13,930 (62.0)	26,300 (117.0)	28,810 (128.2)	30,005 (133.5)	30,005 (133.5)
	10-1/2 (267)	18,575 (82.6)	18,575 (82.6)	18,575 (82.6)	18,575 (82.6)	40,005 (178.0)	40,005 (178.0)	40,005 (178.0)	40,005 (178.0)
	17-1/2 (445)	30,955 (137.7)	30,955 (137.7)	30,955 (137.7)	30,955 (137.7)	66,675 (296.6)	66,675 (296.6)	66,675 (296.6)	66,675 (296.6)
#8	9 (229)	14,920 (66.4)	16,340 (72.7)	18,285 (81.3)	18,285 (81.3)	32,130 (142.9)	35,195 (156.6)	39,385 (175.2)	39,385 (175.2)
	12 (305)	22,965 (102.2)	24,380 (108.4)	24,380 (108.4)	24,380 (108.4)	49,465 (220.0)	52,515 (233.6)	52,515 (233.6)	52,515 (233.6)
	20 (508)	40,635 (180.8)	40,635 (180.8)	40,635 (180.8)	40,635 (180.8)	87,525 (389.3)	87,525 (389.3)	87,525 (389.3)	87,525 (389.3)
#9	10-1/8 (257)	17,800 (79.2)	19,500 (86.7)	22,515 (100.2)	22,560 (100.4)	38,340 (170.5)	42,000 (186.8)	48,495 (215.7)	48,595 (216.2)
	13-1/2 (343)	27,405 (121.9)	30,020 (133.5)	30,085 (133.8)	30,085 (133.8)	59,025 (262.6)	64,660 (287.6)	64,795 (288.2)	64,795 (288.2)
	22-1/2 (572)	50,140 (223.0)	50,140 (223.0)	50,140 (223.0)	50,140 (223.0)	107,990 (480.4)	107,990 (480.4)	107,990 (480.4)	107,990 (480.4)

- 1 See Section 3.1.8 for explanation on development of load values.
- 2 See Section 3.1.8 to convert design strength value to ASD value.
- 3 Linear interpolation between embedment depths and concrete compressive strengths is not permitted.
- 4 Apply spacing, edge distance, and concrete thickness factors in tables 8 - 23 as necessary to the above values. Compare to the steel values in table 7. The lesser of the values is to be used for the design.
- 5 Data is for temperature range A: Max. short term temperature = 130°F (55°C), max. long term temperature = 110°F (43°C). For temperature range B: Max. short term temperature = 176°F (80°C), max. long term temperature = 110°F (43°C) multiply above values by 0.69. Short term elevated concrete temperatures are those that occur over brief intervals, e.g., as a result of diurnal cycling. Long term concrete temperatures are roughly constant over significant periods of time.
- 6 Tabular values are for dry concrete and water-saturated concrete conditions. Water-filled and submerged (under water) applications are not permitted for this hole preparation method.
- 7 Tabular values are for short term loads only. For sustained loads including overhead use, see Section 3.1.8.
- 8 Tabular values are for normal-weight concrete only. For lightweight concrete multiply design strength by λ_s as follows: For sand-lightweight, $\lambda_s = 0.51$. For all-lightweight, $\lambda_s = 0.45$.
- 9 Tabular values are for static loads only. Seismic design is not permitted for uncracked concrete. For seismic loads, multiply cracked concrete tabular values in tension and shear by $\alpha_{seis} = 0.68$. See section 3.1.8 for additional information on seismic applications.

Table 7 - Steel design strength for US rebar¹

Rebar size	ASTM A 615 Grade 40 ²			ASTM A 615 Grade 60 ²			ASTM A 706 Grade 60 ²		
	Tensile ³ ϕN_{sa} lb (kN)	Shear ⁴ ϕV_{sa} lb (kN)	Seismic Shear ⁵ $\phi V_{sa,eq}$ lb (kN)	Tensile ³ ϕN_{sa} lb (kN)	Shear ⁴ ϕV_{sa} lb (kN)	Seismic Shear ⁵ $\phi V_{sa,eq}$ lb (kN)	Tensile ³ ϕN_{sa} lb (kN)	Shear ⁴ ϕV_{sa} lb (kN)	Seismic Shear ⁵ $\phi V_{sa,eq}$ lb (kN)
#3	4,290 (19.1)	2,375 (10.6)	1,665 (7.4)	6,435 (28.6)	3,565 (15.9)	2,495 (11.1)	6,600 (29.4)	3,430 (15.3)	2,400 (10.7)
#4	7,800 (34.7)	4,320 (19.2)	3,025 (13.5)	11,700 (52.0)	6,480 (28.8)	4,535 (20.2)	12,000 (53.4)	6,240 (27.8)	4,370 (19.4)
#5	12,090 (53.8)	6,695 (29.8)	4,685 (20.8)	18,135 (80.7)	10,045 (44.7)	7,030 (31.3)	18,600 (82.7)	9,670 (43.0)	6,770 (30.1)
#6	17,160 (76.3)	9,505 (42.3)	6,655 (29.6)	25,740 (114.5)	14,255 (63.4)	9,980 (44.4)	26,400 (117.4)	13,730 (61.1)	9,610 (42.7)
#7	23,400 (104.1)	12,960 (57.6)	9,070 (40.3)	35,100 (156.1)	19,440 (86.5)	13,610 (60.5)	36,000 (160.1)	18,720 (83.3)	13,105 (58.3)
#8	30,810 (137.0)	17,065 (75.9)	11,945 (53.1)	46,215 (205.6)	25,595 (113.9)	17,915 (79.7)	47,400 (210.8)	24,650 (109.6)	17,255 (76.8)
#9	39,000 (173.5)	21,600 (96.1)	15,120 (67.3)	58,500 (260.2)	32,400 (144.1)	22,680 (100.9)	60,000 (266.9)	31,200 (138.8)	21,840 (97.1)
#10	49,530 (220.3)	27,430 (122.0)	19,200 (85.4)	74,295 (330.5)	41,150 (183.0)	28,805 (128.1)	76,200 (339.0)	39,625 (176.3)	27,740 (123.4)

1 See Section 3.1.8 to convert design strength value to ASD value.

2 ASTM A706 Grade 60 rebar are considered ductile steel elements. ASTM A 615 Grade 40 and 60 rebar are considered brittle steel elements.

3 Tensile = $\phi A_{se,N} f_{uta}$ as noted in ACI 318-14 Chapter 17

4 Shear = $\phi 0.60 A_{se,N} f_{uta}$ as noted in ACI 318-14 Chapter 17

5 Seismic Shear = $\alpha_{V,seis} \phi V_{sa}$: Reduction for seismic shear only. See section 3.1.8 for additional information on seismic applications.

Table 8 - Load adjustment factors for #3 rebar in uncracked concrete^{1,2,3}

Embedment h_{ef}	#3 uncracked concrete	Spacing factor in tension			Edge distance factor in tension			Spacing factor in shear ⁴			Edge distance in shear						Concrete thickness factor in shear ⁵		
		f_{AN}			f_{RN}			f_{AV}			⊥ Toward edge			∥ To and away from edge			f_{HV}		
		3-3/8 (86)	4-1/2 (114)	7-1/2 (191)	3-3/8 (86)	4-1/2 (114)	7-1/2 (191)	3-3/8 (86)	4-1/2 (114)	7-1/2 (191)	3-3/8 (86)	4-1/2 (114)	7-1/2 (191)	3-3/8 (86)	4-1/2 (114)	7-1/2 (191)	3-3/8 (86)	4-1/2 (114)	7-1/2 (191)
1-3/4 (44)	n/a	n/a	n/a	0.29	0.22	0.13	n/a	n/a	n/a	0.07	0.06	0.03	0.15	0.11	0.07	n/a	n/a	n/a	
1-7/8 (48)	0.59	0.57	0.54	0.30	0.22	0.13	0.53	0.53	0.52	0.08	0.06	0.04	0.17	0.12	0.07	n/a	n/a	n/a	
2 (51)	0.59	0.57	0.54	0.31	0.23	0.13	0.53	0.53	0.52	0.09	0.07	0.04	0.18	0.14	0.08	n/a	n/a	n/a	
3 (76)	0.64	0.61	0.57	0.38	0.28	0.16	0.55	0.54	0.53	0.17	0.13	0.08	0.34	0.25	0.15	n/a	n/a	n/a	
4 (102)	0.69	0.65	0.59	0.45	0.33	0.19	0.57	0.56	0.54	0.26	0.19	0.12	0.45	0.33	0.19	n/a	n/a	n/a	
4-5/8 (117)	0.72	0.67	0.60	0.50	0.37	0.22	0.58	0.56	0.55	0.32	0.24	0.14	0.50	0.37	0.22	0.56	n/a	n/a	
5 (127)	0.74	0.69	0.61	0.54	0.39	0.23	0.58	0.57	0.55	0.36	0.27	0.16	0.54	0.39	0.23	0.58	n/a	n/a	
5-3/4 (146)	0.77	0.71	0.63	0.61	0.45	0.26	0.60	0.58	0.56	0.45	0.33	0.20	0.61	0.45	0.26	0.62	0.57	n/a	
6 (152)	0.78	0.72	0.63	0.64	0.47	0.27	0.60	0.58	0.56	0.47	0.36	0.21	0.64	0.47	0.27	0.64	0.58	n/a	
7 (178)	0.83	0.76	0.66	0.75	0.54	0.32	0.62	0.60	0.57	0.60	0.45	0.27	0.75	0.54	0.32	0.69	0.63	n/a	
8 (203)	0.88	0.80	0.68	0.85	0.62	0.36	0.64	0.61	0.58	0.73	0.55	0.33	0.85	0.62	0.36	0.74	0.67	n/a	
8-3/4 (222)	0.91	0.82	0.69	0.93	0.68	0.39	0.65	0.62	0.59	0.84	0.63	0.38	0.93	0.68	0.39	0.77	0.70	0.59	
9 (229)	0.92	0.83	0.70	0.96	0.70	0.41	0.65	0.63	0.59	0.87	0.65	0.39	0.96	0.70	0.41	0.78	0.71	0.60	
10 (254)	0.97	0.87	0.72	1.00	0.78	0.45	0.67	0.64	0.60	1.00	0.77	0.46	1.00	0.78	0.45	0.82	0.75	0.63	
11 (279)	1.00	0.91	0.74		0.85	0.50	0.69	0.65	0.61		0.88	0.53		0.85	0.50	0.86	0.78	0.66	
12 (305)		0.94	0.77		0.93	0.54	0.70	0.67	0.62		1.00	0.60		0.93	0.54	0.90	0.82	0.69	
14 (356)		1.00	0.81		1.00	0.63	0.74	0.70	0.64			0.76		1.00	0.63	0.97	0.88	0.75	
16 (406)			0.86			0.72	0.77	0.72	0.66			0.93			0.72	1.00	0.95	0.80	
18 (457)			0.90			0.81	0.80	0.75	0.68			1.00			0.81	1.00	1.00	0.85	
24 (610)			1.00			1.00	0.91	0.83	0.74						1.00			0.98	
30 (762)							1.00	0.92	0.80									1.00	
36 (914)								1.00	0.86										
> 48 (1219)									0.98										

Table 9 - Load adjustment factors for #3 rebar in cracked concrete^{1,2,3}

Embedment h_{ef}	#3 cracked concrete	Spacing factor in tension			Edge distance factor in tension			Spacing factor in shear ⁴			Edge distance in shear						Concrete thickness factor in shear ⁵		
		f_{AN}			f_{RN}			f_{AV}			⊥ Toward edge			∥ To and away from edge			f_{HV}		
		3-3/8 (86)	4-1/2 (114)	7-1/2 (191)	3-3/8 (86)	4-1/2 (114)	7-1/2 (191)	3-3/8 (86)	4-1/2 (114)	7-1/2 (191)	3-3/8 (86)	4-1/2 (114)	7-1/2 (191)	3-3/8 (86)	4-1/2 (114)	7-1/2 (191)	3-3/8 (86)	4-1/2 (114)	7-1/2 (191)
1-3/4 (44)	n/a	n/a	n/a	0.53	0.49	0.43	n/a	n/a	n/a	0.07	0.05	0.03	0.14	0.11	0.06	n/a	n/a	n/a	
1-7/8 (48)	0.59	0.57	0.54	0.55	0.50	0.44	0.53	0.53	0.52	0.08	0.06	0.03	0.16	0.12	0.07	n/a	n/a	n/a	
2 (51)	0.59	0.57	0.54	0.56	0.51	0.44	0.53	0.53	0.52	0.09	0.06	0.04	0.17	0.13	0.08	n/a	n/a	n/a	
3 (76)	0.64	0.61	0.57	0.68	0.60	0.49	0.55	0.54	0.53	0.16	0.12	0.07	0.32	0.24	0.14	n/a	n/a	n/a	
4 (102)	0.69	0.65	0.59	0.81	0.70	0.55	0.57	0.55	0.54	0.25	0.18	0.11	0.49	0.36	0.22	n/a	n/a	n/a	
4-5/8 (117)	0.72	0.67	0.60	0.90	0.76	0.58	0.58	0.56	0.54	0.31	0.23	0.14	0.61	0.45	0.27	0.55	n/a	n/a	
5 (127)	0.74	0.69	0.61	0.95	0.80	0.60	0.58	0.57	0.55	0.34	0.25	0.15	0.69	0.51	0.30	0.57	n/a	n/a	
5-3/4 (146)	0.77	0.71	0.63	1.00	0.88	0.64	0.59	0.58	0.55	0.42	0.31	0.19	0.85	0.63	0.38	0.61	0.55	n/a	
6 (152)	0.78	0.72	0.63		0.91	0.66	0.60	0.58	0.56	0.45	0.33	0.20	0.91	0.67	0.40	0.63	0.57	n/a	
7 (178)	0.83	0.76	0.66		1.00	0.72	0.61	0.59	0.57	0.57	0.42	0.25	1.00	0.84	0.50	0.68	0.61	n/a	
8 (203)	0.88	0.80	0.68			0.78	0.63	0.61	0.58	0.70	0.51	0.31		1.00	0.62	0.72	0.65	n/a	
8-3/4 (222)	0.91	0.82	0.69			0.83	0.64	0.62	0.58	0.80	0.59	0.35			0.70	0.76	0.68	0.58	
9 (229)	0.92	0.83	0.70			0.85	0.65	0.62	0.59	0.83	0.61	0.37			0.74	0.77	0.69	0.58	
10 (254)	0.97	0.87	0.72			0.91	0.66	0.63	0.60	0.97	0.72	0.43			0.86	0.81	0.73	0.62	
11 (279)	1.00	0.91	0.74			0.98	0.68	0.65	0.60	1.00	0.83	0.50			0.98	0.85	0.77	0.65	
12 (305)		0.94	0.77			1.00	0.70	0.66	0.61		0.94	0.57			1.00	0.89	0.80	0.68	
14 (356)		1.00	0.81				0.73	0.69	0.63		1.00	0.71				0.96	0.86	0.73	
16 (406)			0.86				0.76	0.71	0.65			0.87				1.00	0.92	0.78	
18 (457)			0.90				0.79	0.74	0.67			1.00					0.98	0.83	
24 (610)			1.00				0.89	0.82	0.73			1.00					1.00	0.96	
30 (762)							0.99	0.90	0.79			1.00						1.00	
36 (914)							1.00	0.98	0.84			1.00							
> 48 (1219)								1.00	0.96			1.00							

- 1 Linear interpolation not permitted.
- 2 Shaded area with reduced edge distance is permitted provided the rebar has no installation torque.
- 3 When combining multiple load adjustment factors (e.g. for a four-anchor pattern in a corner with thin concrete member) the design can become very conservative. To optimize the design, use Hilti PROFIS Anchor Design software or perform anchor calculation using design equations from ACI 318-14 Chapter 17.
- 4 Spacing factor reduction in shear applicable when $c < 3 \cdot h_{ef}$, f_{AV} is applicable when edge distance, $c < 3 \cdot h_{ef}$. If $c \geq 3 \cdot h_{ef}$, then $f_{AV} = f_{AN}$.
- 5 Concrete thickness reduction factor in shear, f_{HV} is applicable when edge distance, $c < 3 \cdot h_{ef}$. If $c \geq 3 \cdot h_{ef}$, then $f_{HV} = 1.0$.

Table 10 - Load adjustment factors for #4 rebar in uncracked concrete^{1,2,3}

Embedment h_{ef}	#4 un-cracked concrete	Spacing factor in tension f_{AN}			Edge distance factor in tension f_{RN}			Spacing factor in shear ⁴ f_{AV}			Edge distance in shear						Concrete thickness factor in shear ⁵ f_{HV}			
		in. (mm)	f_{AN}			f_{RN}			f_{AV}			⊥ Toward edge f_{RV}			∥ To and away from edge f_{RV}			f_{HV}		
			4-1/2 (114)	6 (152)	10 (254)	4-1/2 (114)	6 (152)	10 (254)	4-1/2 (114)	6 (152)	10 (254)	4-1/2 (114)	6 (152)	10 (254)	4-1/2 (114)	6 (152)	10 (254)	4-1/2 (114)	6 (152)	10 (254)
1-3/4 (44)	n/a	n/a	n/a	0.26	0.20	0.11	n/a	n/a	n/a	0.05	0.04	0.02	0.11	0.07	0.04	n/a	n/a	n/a		
2-1/2 (64)	0.59	0.57	0.54	0.29	0.22	0.13	0.53	0.53	0.52	0.09	0.06	0.04	0.18	0.13	0.08	n/a	n/a	n/a		
3 (76)	0.61	0.58	0.55	0.32	0.24	0.14	0.54	0.53	0.52	0.12	0.08	0.05	0.24	0.17	0.10	n/a	n/a	n/a		
4 (102)	0.64	0.61	0.57	0.37	0.28	0.16	0.55	0.54	0.53	0.18	0.13	0.08	0.37	0.26	0.15	n/a	n/a	n/a		
5 (127)	0.68	0.64	0.58	0.42	0.32	0.18	0.57	0.55	0.54	0.26	0.18	0.11	0.42	0.32	0.18	n/a	n/a	n/a		
5-3/4 (146)	0.70	0.66	0.60	0.47	0.35	0.20	0.58	0.56	0.54	0.32	0.22	0.13	0.47	0.35	0.20	0.56	n/a	n/a		
6 (152)	0.71	0.67	0.60	0.48	0.36	0.21	0.58	0.56	0.55	0.34	0.24	0.14	0.48	0.36	0.21	0.57	n/a	n/a		
7 (178)	0.75	0.69	0.62	0.55	0.40	0.24	0.59	0.57	0.55	0.42	0.30	0.18	0.55	0.40	0.24	0.61	n/a	n/a		
7-1/4 (184)	0.76	0.70	0.62	0.57	0.42	0.24	0.60	0.58	0.55	0.45	0.31	0.19	0.57	0.42	0.24	0.62	0.55	n/a		
8 (203)	0.79	0.72	0.63	0.63	0.46	0.27	0.61	0.58	0.56	0.52	0.36	0.22	0.63	0.46	0.27	0.66	0.58	n/a		
9 (229)	0.82	0.75	0.65	0.70	0.52	0.30	0.62	0.60	0.57	0.62	0.43	0.26	0.70	0.52	0.30	0.70	0.62	n/a		
10 (254)	0.86	0.78	0.67	0.78	0.57	0.34	0.63	0.61	0.58	0.72	0.51	0.30	0.78	0.57	0.34	0.73	0.65	n/a		
11-1/4 (286)	0.90	0.81	0.69	0.88	0.65	0.38	0.65	0.62	0.58	0.86	0.60	0.36	0.88	0.65	0.38	0.78	0.69	0.58		
12 (305)	0.93	0.83	0.70	0.94	0.69	0.40	0.66	0.63	0.59	0.95	0.67	0.40	0.94	0.69	0.40	0.80	0.71	0.60		
14 (356)	1.00	0.89	0.73	1.00	0.80	0.47	0.69	0.65	0.61	1.00	0.84	0.50	1.00	0.80	0.47	0.87	0.77	0.65		
16 (406)		0.94	0.77		0.92	0.54	0.72	0.67	0.62		1.00	0.61		0.92	0.54	0.93	0.82	0.69		
18 (457)		1.00	0.80		1.00	0.60	0.74	0.69	0.64			0.73		1.00	0.60	0.98	0.87	0.74		
20 (508)			0.83			0.67	0.77	0.71	0.65			0.86			0.67	1.00	0.92	0.78		
22 (559)			0.87			0.74	0.80	0.73	0.67			0.99			0.74		0.97	0.81		
24 (610)			0.90			0.81	0.82	0.75	0.68			1.00			0.81		1.00	0.85		
30 (762)			1.00			1.00	0.90	0.82	0.73						1.00			0.95		
36 (914)							0.98	0.88	0.77									1.00		
> 48 (1219)							1.00	1.00	0.86											

3.2.3

Table 11 - Load adjustment factors for #4 rebar in cracked concrete^{1,2,3}

Embedment h_{ef}	#4 cracked concrete	Spacing factor in tension f_{AN}			Edge distance factor in tension f_{RN}			Spacing factor in shear ⁴ f_{AV}			Edge distance in shear						Concrete thickness factor in shear ⁵ f_{HV}			
		in. (mm)	f_{AN}			f_{RN}			f_{AV}			⊥ Toward edge f_{RV}			∥ To and away from edge f_{RV}			f_{HV}		
			4-1/2 (114)	6 (152)	10 (254)	4-1/2 (114)	6 (152)	10 (254)	4-1/2 (114)	6 (152)	10 (254)	4-1/2 (114)	6 (152)	10 (254)	4-1/2 (114)	6 (152)	10 (254)	4-1/2 (114)	6 (152)	10 (254)
1-3/4 (44)	n/a	n/a	n/a	0.48	0.45	0.41	n/a	n/a	n/a	0.05	0.03	0.02	0.11	0.07	0.04	n/a	n/a	n/a		
2-1/2 (64)	0.59	0.57	0.54	0.55	0.50	0.44	0.53	0.53	0.52	0.09	0.06	0.03	0.18	0.12	0.07	n/a	n/a	n/a		
3 (76)	0.61	0.58	0.55	0.59	0.53	0.46	0.54	0.53	0.52	0.12	0.08	0.05	0.24	0.16	0.09	n/a	n/a	n/a		
4 (102)	0.64	0.61	0.57	0.68	0.60	0.49	0.55	0.54	0.53	0.18	0.12	0.07	0.37	0.24	0.14	n/a	n/a	n/a		
5 (127)	0.68	0.64	0.58	0.78	0.67	0.53	0.57	0.55	0.54	0.26	0.17	0.10	0.52	0.34	0.20	n/a	n/a	n/a		
5-3/4 (146)	0.70	0.66	0.60	0.86	0.73	0.56	0.58	0.56	0.54	0.32	0.21	0.12	0.64	0.41	0.24	0.56	n/a	n/a		
6 (152)	0.71	0.67	0.60	0.89	0.75	0.57	0.58	0.56	0.54	0.34	0.22	0.13	0.68	0.44	0.26	0.57	n/a	n/a		
7 (178)	0.75	0.69	0.62	1.00	0.83	0.62	0.59	0.57	0.55	0.43	0.28	0.16	0.86	0.56	0.33	0.62	n/a	n/a		
7-1/4 (184)	0.76	0.70	0.62		0.85	0.63	0.60	0.57	0.55	0.45	0.29	0.17	0.90	0.59	0.34	0.63	0.54	n/a		
8 (203)	0.79	0.72	0.63		0.91	0.66	0.61	0.58	0.56	0.52	0.34	0.20	1.00	0.68	0.40	0.66	0.57	n/a		
9 (229)	0.82	0.75	0.65		1.00	0.70	0.62	0.59	0.56	0.62	0.41	0.24		0.81	0.47	0.70	0.60	n/a		
10 (254)	0.86	0.78	0.67			0.75	0.64	0.60	0.57	0.73	0.47	0.28		0.95	0.56	0.74	0.64	n/a		
11-1/4 (286)	0.90	0.81	0.69			0.81	0.65	0.61	0.58	0.87	0.57	0.33		1.00	0.66	0.78	0.68	0.56		
12 (305)	0.93	0.83	0.70			0.85	0.66	0.62	0.59	0.96	0.62	0.36			0.73	0.81	0.70	0.58		
14 (356)	1.00	0.89	0.73			0.95	0.69	0.64	0.60	1.00	0.79	0.46			0.92	0.87	0.75	0.63		
16 (406)		0.94	0.77			1.00	0.72	0.66	0.61		0.96	0.56			1.00	0.93	0.81	0.67		
18 (457)		1.00	0.80				0.74	0.68	0.63		1.00	0.67				0.99	0.85	0.71		
20 (508)			0.83				0.77	0.70	0.64			0.79				1.00	0.90	0.75		
22 (559)			0.87				0.80	0.72	0.66			0.91					0.94	0.79		
24 (610)			0.90				0.82	0.74	0.67			1.00					0.99	0.83		
30 (762)			1.00				0.91	0.80	0.71								1.00	0.92		
36 (914)							0.99	0.87	0.76									1.00		
> 48 (1219)							1.00	0.99	0.84											

- Linear interpolation not permitted.
- Shaded area with reduced edge distance is permitted provided the rebar has no installation torque.
- When combining multiple load adjustment factors (e.g. for a four-anchor pattern in a corner with thin concrete member) the design can become very conservative. To optimize the design, use Hilti PROFIS Anchor Design software or perform anchor calculation using design equations from ACI 318-14 Chapter 17.
- Spacing factor reduction in shear applicable when $c < 3 \cdot h_{ef}$. f_{AV} is applicable when edge distance, $c < 3 \cdot h_{ef}$. If $c \geq 3 \cdot h_{ef}$, then $f_{AV} = f_{AN}$.
- Concrete thickness reduction factor in shear, f_{HV} is applicable when edge distance, $c < 3 \cdot h_{ef}$. If $c \geq 3 \cdot h_{ef}$, then $f_{HV} = 1.0$.

Table 12 - Load adjustment factors for #5 rebar in uncracked concrete^{1,2,3}

Embedment h_{ef}	#5 uncracked concrete	Spacing factor in tension			Edge distance factor in tension			Spacing factor in shear ⁴			Edge distance in shear						Concrete thickness factor in shear ⁵		
		f_{AN}			f_{RN}			f_{AV}			⊥ Toward edge f_{RV}			∥ To and away from edge f_{RV}			f_{HV}		
		5-5/8 (143)	7-1/2 (191)	12-1/2 (318)	5-5/8 (143)	7-1/2 (191)	12-1/2 (318)	5-5/8 (143)	7-1/2 (191)	12-1/2 (318)	5-5/8 (143)	7-1/2 (191)	12-1/2 (318)	5-5/8 (143)	7-1/2 (191)	12-1/2 (318)	5-5/8 (143)	7-1/2 (191)	12-1/2 (318)
1-3/4 (44)	n/a	n/a	n/a	0.24	0.18	0.11	n/a	n/a	n/a	0.04	0.03	0.02	0.08	0.06	0.03	n/a	n/a	n/a	
3-1/8 (79)	0.59	0.57	0.54	0.29	0.22	0.13	0.54	0.53	0.52	0.10	0.07	0.04	0.20	0.13	0.08	n/a	n/a	n/a	
4 (102)	0.61	0.59	0.55	0.33	0.25	0.14	0.55	0.53	0.52	0.15	0.10	0.06	0.29	0.19	0.11	n/a	n/a	n/a	
5 (127)	0.64	0.61	0.57	0.37	0.28	0.16	0.56	0.54	0.53	0.21	0.13	0.08	0.37	0.27	0.16	n/a	n/a	n/a	
6 (152)	0.67	0.63	0.58	0.41	0.31	0.18	0.57	0.55	0.54	0.27	0.18	0.10	0.41	0.31	0.18	n/a	n/a	n/a	
7 (178)	0.70	0.66	0.59	0.46	0.34	0.20	0.58	0.56	0.54	0.34	0.22	0.13	0.46	0.34	0.20	n/a	n/a	n/a	
7-1/8 (181)	0.70	0.66	0.60	0.46	0.34	0.20	0.58	0.56	0.54	0.35	0.23	0.13	0.46	0.34	0.20	0.57	n/a	n/a	
8 (203)	0.73	0.68	0.61	0.51	0.38	0.22	0.59	0.57	0.55	0.41	0.27	0.16	0.51	0.38	0.22	0.61	n/a	n/a	
9 (229)	0.76	0.70	0.62	0.56	0.41	0.24	0.60	0.58	0.55	0.50	0.32	0.19	0.56	0.41	0.24	0.65	0.56	n/a	
10 (254)	0.79	0.72	0.63	0.63	0.46	0.27	0.62	0.59	0.56	0.58	0.38	0.22	0.63	0.46	0.27	0.68	0.59	n/a	
11 (279)	0.82	0.74	0.65	0.69	0.51	0.30	0.63	0.60	0.57	0.67	0.43	0.25	0.69	0.51	0.30	0.71	0.62	n/a	
12 (305)	0.84	0.77	0.66	0.75	0.55	0.32	0.64	0.60	0.57	0.76	0.50	0.29	0.75	0.55	0.32	0.75	0.65	n/a	
14 (356)	0.90	0.81	0.69	0.88	0.64	0.38	0.66	0.62	0.59	0.96	0.62	0.36	0.88	0.64	0.38	0.81	0.70	0.58	
16 (406)	0.96	0.86	0.71	1.00	0.74	0.43	0.69	0.64	0.60	1.00	0.76	0.45	1.00	0.74	0.43	0.86	0.75	0.62	
18 (457)	1.00	0.90	0.74		0.83	0.49	0.71	0.66	0.61		0.91	0.53		0.83	0.49	0.91	0.79	0.66	
20 (508)		0.94	0.77		0.92	0.54	0.73	0.67	0.62		1.00	0.62		0.92	0.54	0.96	0.83	0.70	
22 (559)		0.99	0.79		1.00	0.59	0.75	0.69	0.63			0.72		1.00	0.59	1.00	0.87	0.73	
24 (610)		1.00	0.82			0.65	0.78	0.71	0.65			0.82			0.65		0.91	0.76	
26 (660)			0.85			0.70	0.80	0.73	0.66			0.92			0.70		0.95	0.79	
28 (711)			0.87			0.75	0.82	0.74	0.67			1.00			0.75		0.99	0.82	
30 (762)			0.90			0.81	0.85	0.76	0.68						0.81		1.00	0.85	
36 (914)			0.98			0.97	0.92	0.81	0.72						0.97			0.94	
> 48 (1219)			1.00			1.00	1.00	0.92	0.79						1.00			1.00	

Table 13 - Load adjustment factors for #5 rebar in cracked concrete^{1,2,3}

Embedment h_{ef}	#5 cracked concrete	Spacing factor in tension			Edge distance factor in tension			Spacing factor in shear ⁴			Edge distance in shear						Concrete thickness factor in shear ⁵		
		f_{AN}			f_{RN}			f_{AV}			⊥ Toward edge f_{RV}			∥ To and away from edge f_{RV}			f_{HV}		
		5-5/8 (143)	7-1/2 (191)	12-1/2 (318)	5-5/8 (143)	7-1/2 (191)	12-1/2 (318)	5-5/8 (143)	7-1/2 (191)	12-1/2 (318)	5-5/8 (143)	7-1/2 (191)	12-1/2 (318)	5-5/8 (143)	7-1/2 (191)	12-1/2 (318)	5-5/8 (143)	7-1/2 (191)	12-1/2 (318)
1-3/4 (44)	n/a	n/a	n/a	0.46	0.43	0.40	n/a	n/a	n/a	0.04	0.03	0.01	0.09	0.06	0.03	n/a	n/a	n/a	
3-1/8 (79)	0.59	0.57	0.54	0.55	0.50	0.44	0.54	0.53	0.52	0.10	0.07	0.03	0.20	0.13	0.07	n/a	n/a	n/a	
4 (102)	0.61	0.59	0.55	0.61	0.55	0.46	0.55	0.53	0.52	0.15	0.10	0.05	0.30	0.19	0.10	n/a	n/a	n/a	
5 (127)	0.64	0.61	0.57	0.69	0.60	0.49	0.56	0.54	0.53	0.21	0.13	0.07	0.41	0.27	0.14	n/a	n/a	n/a	
6 (152)	0.67	0.63	0.58	0.77	0.66	0.53	0.57	0.55	0.53	0.27	0.18	0.09	0.54	0.35	0.18	n/a	n/a	n/a	
7 (178)	0.70	0.66	0.59	0.85	0.72	0.56	0.58	0.56	0.54	0.34	0.22	0.11	0.68	0.44	0.23	n/a	n/a	n/a	
7-1/8 (181)	0.70	0.66	0.60	0.86	0.73	0.56	0.58	0.56	0.54	0.35	0.23	0.12	0.70	0.46	0.23	0.58	n/a	n/a	
8 (203)	0.73	0.68	0.61	0.93	0.78	0.59	0.59	0.57	0.54	0.42	0.27	0.14	0.84	0.54	0.28	0.61	n/a	n/a	
9 (229)	0.76	0.70	0.62	1.00	0.85	0.62	0.60	0.58	0.55	0.50	0.32	0.17	1.00	0.65	0.33	0.65	0.56	n/a	
10 (254)	0.79	0.72	0.63		0.91	0.66	0.62	0.59	0.56	0.58	0.38	0.19		0.76	0.39	0.68	0.59	n/a	
11 (279)	0.82	0.74	0.65		0.98	0.69	0.63	0.60	0.56	0.67	0.44	0.22		0.88	0.45	0.72	0.62	n/a	
12 (305)	0.84	0.77	0.66		1.00	0.73	0.64	0.60	0.57	0.77	0.50	0.26		1.00	0.51	0.75	0.65	n/a	
14 (356)	0.90	0.81	0.69			0.81	0.66	0.62	0.58	0.97	0.63	0.32			0.64	0.81	0.70	0.56	
16 (406)	0.96	0.86	0.71			0.89	0.69	0.64	0.59	1.00	0.77	0.39			0.79	0.86	0.75	0.60	
18 (457)	1.00	0.90	0.74			0.97	0.71	0.66	0.60		0.92	0.47			0.94	0.92	0.79	0.63	
20 (508)		0.94	0.77			1.00	0.73	0.67	0.61		1.00	0.55			1.00	0.97	0.84	0.67	
22 (559)		0.99	0.79				0.76	0.69	0.62			0.63			1.00	0.88	0.70		
24 (610)		1.00	0.82				0.78	0.71	0.63			0.72					0.92	0.73	
26 (660)			0.85				0.80	0.73	0.65			0.81					0.95	0.76	
28 (711)			0.87				0.83	0.74	0.66			0.91					0.99	0.79	
30 (762)			0.90				0.85	0.76	0.67			1.00					1.00	0.82	
36 (914)			0.98				0.92	0.81	0.70									0.90	
> 48 (1219)			1.00				1.00	0.92	0.77									1.00	

- 1 Linear interpolation not permitted.
- 2 Shaded area with reduced edge distance is permitted provided the rebar has no installation torque.
- 3 When combining multiple load adjustment factors (e.g. for a four-anchor pattern in a corner with thin concrete member) the design can become very conservative. To optimize the design, use Hilti PROFIS Anchor Design software or perform anchor calculation using design equations from ACI 318-14 Chapter 17.
- 4 Spacing factor reduction in shear applicable when $c < 3 \cdot h_{ef}$. f_{AV} is applicable when edge distance, $c < 3 \cdot h_{ef}$. If $c \geq 3 \cdot h_{ef}$, then $f_{AV} = f_{AN}$.
- 5 Concrete thickness reduction factor in shear, f_{HV} is applicable when edge distance, $c < 3 \cdot h_{ef}$. If $c \geq 3 \cdot h_{ef}$, then $f_{HV} = 1.0$.

Table 14 - Load adjustment factors for #6 rebar in uncracked concrete^{1,2,3}

Embedment h_{ef}	#6 uncracked concrete	Spacing factor in tension f_{AN}			Edge distance factor in tension f_{RN}			Spacing factor in shear ⁴ f_{AV}			Edge distance in shear						Concrete thickness factor in shear ⁵ f_{HV}			
		in. (mm)	6-3/4 (171)	9 (229)	15 (381)	6-3/4 (171)	9 (229)	15 (381)	6-3/4 (171)	9 (229)	15 (381)	⊥ Toward edge f_{RV}			To and away from edge f_{RV}			6-3/4 (171)	9 (229)	15 (381)
												6-3/4 (171)	9 (229)	15 (381)	6-3/4 (171)	9 (229)	15 (381)			
1-3/4 (44)	n/a	n/a	n/a	n/a	0.24	0.18	0.10	n/a	n/a	n/a	0.03	0.02	0.01	0.07	0.05	0.02	n/a	n/a	n/a	
3-3/4 (95)	0.59	0.57	0.54	0.54	0.30	0.22	0.13	0.54	0.53	0.52	0.11	0.07	0.04	0.22	0.14	0.08	n/a	n/a	n/a	
4 (102)	0.60	0.57	0.54	0.54	0.31	0.23	0.13	0.54	0.53	0.52	0.12	0.08	0.04	0.24	0.16	0.08	n/a	n/a	n/a	
5 (127)	0.62	0.59	0.56	0.56	0.34	0.25	0.15	0.55	0.54	0.53	0.17	0.11	0.06	0.33	0.22	0.12	n/a	n/a	n/a	
6 (152)	0.64	0.61	0.57	0.58	0.38	0.28	0.16	0.56	0.55	0.53	0.22	0.14	0.08	0.38	0.28	0.16	n/a	n/a	n/a	
7 (178)	0.67	0.63	0.58	0.58	0.41	0.30	0.18	0.57	0.55	0.54	0.28	0.18	0.10	0.41	0.30	0.18	n/a	n/a	n/a	
8 (203)	0.69	0.65	0.59	0.59	0.45	0.33	0.19	0.58	0.56	0.54	0.34	0.22	0.12	0.45	0.33	0.19	n/a	n/a	n/a	
8-1/2 (216)	0.70	0.66	0.59	0.59	0.47	0.34	0.20	0.59	0.56	0.54	0.37	0.24	0.13	0.47	0.34	0.20	0.59	n/a	n/a	
9 (229)	0.72	0.67	0.60	0.60	0.49	0.36	0.21	0.59	0.57	0.55	0.40	0.26	0.14	0.49	0.36	0.21	0.60	n/a	n/a	
10 (254)	0.74	0.69	0.61	0.61	0.53	0.39	0.23	0.60	0.58	0.55	0.47	0.31	0.17	0.53	0.39	0.23	0.64	n/a	n/a	
10-3/4 (273)	0.76	0.70	0.62	0.62	0.57	0.41	0.24	0.61	0.58	0.55	0.53	0.34	0.19	0.57	0.41	0.24	0.66	0.57	n/a	
12 (305)	0.79	0.72	0.63	0.63	0.64	0.46	0.27	0.62	0.59	0.56	0.62	0.40	0.22	0.64	0.46	0.27	0.70	0.60	n/a	
14 (356)	0.84	0.76	0.66	0.66	0.74	0.54	0.32	0.64	0.61	0.57	0.78	0.51	0.28	0.74	0.54	0.32	0.75	0.65	n/a	
16 (406)	0.89	0.80	0.68	0.68	0.85	0.62	0.36	0.66	0.62	0.58	0.96	0.62	0.34	0.85	0.62	0.36	0.80	0.70	n/a	
16-3/4 (425)	0.90	0.81	0.69	0.69	0.89	0.65	0.38	0.67	0.63	0.58	1.00	0.67	0.36	0.89	0.65	0.38	0.82	0.71	0.58	
18 (457)	0.93	0.83	0.70	0.70	0.96	0.69	0.41	0.68	0.64	0.59		0.74	0.40	0.96	0.69	0.41	0.85	0.74	0.60	
20 (508)	0.98	0.87	0.72	0.72	1.00	0.77	0.45	0.70	0.65	0.60		0.87	0.47	1.00	0.77	0.45	0.90	0.78	0.64	
22 (559)	1.00	0.91	0.74	0.74		0.85	0.50	0.72	0.67	0.61		1.00	0.54		0.85	0.50	0.94	0.82	0.67	
24 (610)		0.94	0.77	0.77		0.93	0.54	0.74	0.68	0.62			0.62		0.93	0.54	0.99	0.85	0.70	
26 (660)		0.98	0.79	0.79		1.00	0.59	0.76	0.70	0.63			0.70		1.00	0.59	1.00	0.89	0.72	
28 (711)		1.00	0.81	0.81			0.63	0.78	0.71	0.64			0.78			0.63		0.92	0.75	
30 (762)			0.83	0.83			0.68	0.80	0.73	0.65			0.87			0.68		0.95	0.78	
36 (914)			0.90	0.90			0.81	0.86	0.77	0.68			1.00			0.81		1.00	0.85	
> 48 (1219)			1.00	1.00			1.00	0.99	0.86	0.74						1.00			0.98	

3.2.3

Table 15 - Load adjustment factors for #6 rebar in cracked concrete^{1,2,3}

Embedment h_{ef}	#6 cracked concrete	Spacing factor in tension f_{AN}			Edge distance factor in tension f_{RN}			Spacing factor in shear ⁴ f_{AV}			Edge distance in shear						Concrete thickness factor in shear ⁵ f_{HV}			
		in. (mm)	6-3/4 (171)	9 (229)	15 (381)	6-3/4 (171)	9 (229)	15 (381)	6-3/4 (171)	9 (229)	15 (381)	⊥ Toward edge f_{RV}			To and away from edge f_{RV}			6-3/4 (171)	9 (229)	15 (381)
												6-3/4 (171)	9 (229)	15 (381)	6-3/4 (171)	9 (229)	15 (381)			
1-3/4 (44)	n/a	n/a	n/a	n/a	0.44	0.42	0.39	n/a	n/a	n/a	0.03	0.02	0.01	0.07	0.05	0.02	n/a	n/a	n/a	
3-3/4 (95)	0.59	0.57	0.54	0.54	0.55	0.50	0.44	0.54	0.53	0.52	0.11	0.07	0.03	0.22	0.14	0.07	n/a	n/a	n/a	
4 (102)	0.60	0.57	0.54	0.54	0.57	0.51	0.44	0.54	0.53	0.52	0.12	0.08	0.04	0.24	0.16	0.07	n/a	n/a	n/a	
5 (127)	0.62	0.59	0.56	0.56	0.63	0.56	0.47	0.55	0.54	0.52	0.17	0.11	0.05	0.34	0.22	0.10	n/a	n/a	n/a	
6 (152)	0.64	0.61	0.57	0.58	0.69	0.60	0.49	0.56	0.55	0.53	0.22	0.14	0.07	0.44	0.29	0.13	n/a	n/a	n/a	
7 (178)	0.67	0.63	0.58	0.58	0.76	0.65	0.52	0.57	0.55	0.53	0.28	0.18	0.08	0.56	0.36	0.17	n/a	n/a	n/a	
8 (203)	0.69	0.65	0.59	0.59	0.82	0.70	0.55	0.58	0.56	0.54	0.34	0.22	0.10	0.68	0.44	0.21	n/a	n/a	n/a	
8-1/2 (216)	0.70	0.66	0.59	0.59	0.86	0.72	0.56	0.59	0.56	0.54	0.37	0.24	0.11	0.75	0.49	0.23	0.59	n/a	n/a	
9 (229)	0.72	0.67	0.60	0.60	0.90	0.75	0.57	0.59	0.57	0.54	0.41	0.26	0.12	0.82	0.53	0.25	0.61	n/a	n/a	
10 (254)	0.74	0.69	0.61	0.61	0.97	0.80	0.60	0.60	0.58	0.55	0.48	0.31	0.14	0.95	0.62	0.29	0.64	n/a	n/a	
10-3/4 (273)	0.76	0.70	0.62	0.62	1.00	0.84	0.62	0.61	0.58	0.55	0.53	0.35	0.16	1.00	0.69	0.32	0.66	0.57	n/a	
12 (305)	0.79	0.72	0.63	0.63		0.91	0.66	0.62	0.59	0.55	0.63	0.41	0.19		0.82	0.38	0.70	0.61	n/a	
14 (356)	0.84	0.76	0.66	0.66		1.00	0.72	0.64	0.61	0.56	0.79	0.51	0.24		1.00	0.48	0.76	0.65	n/a	
16 (406)	0.89	0.80	0.68	0.68			0.78	0.66	0.62	0.57	0.97	0.63	0.29			0.58	0.81	0.70	n/a	
16-3/4 (425)	0.90	0.81	0.69	0.69			0.81	0.67	0.63	0.58	1.00	0.67	0.31			0.62	0.83	0.72	0.55	
18 (457)	0.93	0.83	0.70	0.70			0.85	0.68	0.64	0.58		0.75	0.35			0.70	0.86	0.74	0.57	
20 (508)	0.98	0.87	0.72	0.72			0.91	0.70	0.65	0.59		0.88	0.41			0.82	0.90	0.78	0.61	
22 (559)	1.00	0.91	0.74	0.74			0.98	0.72	0.67	0.60		1.00	0.47			0.94	0.95	0.82	0.63	
24 (610)		0.94	0.77	0.77			1.00	0.74	0.68	0.61			0.54			1.00	0.99	0.86	0.66	
26 (660)		0.98	0.79	0.79				0.76	0.70	0.62			0.60				1.00	0.89	0.69	
28 (711)		1.00	0.81	0.81				0.79	0.71	0.63			0.68					0.92	0.72	
30 (762)			0.83	0.83				0.81	0.73	0.64			0.75					0.96	0.74	
36 (914)			0.90	0.90				0.87	0.77	0.66			0.98					1.00	0.81	
> 48 (1219)			1.00	1.00				0.99	0.87	0.72			1.00						0.94	

- Linear interpolation not permitted.
- Shaded area with reduced edge distance is permitted provided the rebar has no installation torque.
- When combining multiple load adjustment factors (e.g. for a four-anchor pattern in a corner with thin concrete member) the design can become very conservative. To optimize the design, use Hilti PROFIS Anchor Design software or perform anchor calculation using design equations from ACI 318 Chapter 17.
- Spacing factor reduction in shear applicable when $c < 3 \cdot h_{ef}$. f_{AV} is applicable when edge distance, $c < 3 \cdot h_{ef}$. If $c \geq 3 \cdot h_{ef}$, then $f_{AV} = f_{AN}$.
- Concrete thickness reduction factor in shear, f_{HV} is applicable when edge distance, $c < 3 \cdot h_{ef}$. If $c \geq 3 \cdot h_{ef}$, then $f_{HV} = 1.0$.

Table 16 - Load adjustment factors for #7 rebar in uncracked concrete^{1,2,3}

#7 uncracked concrete	Embedment h_{ef}	in. (mm)	Spacing factor in tension			Edge distance factor in tension			Spacing factor in shear ⁴			Edge distance in shear						Concrete thickness factor in shear ⁵		
			f_{AN}			f_{RN}			f_{AV}			f_{RV}			f_{RV}			f_{HV}		
			7-7/8 (200)	10-1/2 (267)	17-1/2 (445)	7-7/8 (200)	10-1/2 (267)	17-1/2 (445)	7-7/8 (200)	10-1/2 (267)	17-1/2 (445)	7-7/8 (200)	10-1/2 (267)	17-1/2 (445)	7-7/8 (200)	10-1/2 (267)	17-1/2 (445)	7-7/8 (200)	10-1/2 (267)	17-1/2 (445)
Spacing (s) / edge distance (c _e) / concrete thickness (h _c) - in. (mm)	1-3/4 (44)	n/a	n/a	n/a	0.24	0.17	0.10	n/a	n/a	n/a	0.03	0.02	0.01	0.05	0.04	0.02	n/a	n/a	n/a	
	4-3/8 (111)	0.59	0.57	0.54	0.31	0.22	0.13	0.54	0.53	0.52	0.11	0.07	0.04	0.22	0.14	0.07	n/a	n/a	n/a	
	5 (127)	0.60	0.58	0.55	0.33	0.23	0.14	0.54	0.53	0.52	0.13	0.09	0.04	0.27	0.17	0.09	n/a	n/a	n/a	
	6 (152)	0.62	0.60	0.56	0.36	0.25	0.15	0.55	0.54	0.52	0.17	0.11	0.06	0.35	0.23	0.12	n/a	n/a	n/a	
	7 (178)	0.65	0.61	0.57	0.39	0.28	0.16	0.56	0.55	0.53	0.22	0.14	0.07	0.39	0.28	0.15	n/a	n/a	n/a	
	8 (203)	0.67	0.63	0.58	0.42	0.30	0.18	0.57	0.55	0.53	0.27	0.17	0.09	0.42	0.30	0.18	n/a	n/a	n/a	
	9 (229)	0.69	0.64	0.59	0.45	0.32	0.19	0.58	0.56	0.54	0.32	0.21	0.11	0.45	0.32	0.19	n/a	n/a	n/a	
	9-7/8 (251)	0.71	0.66	0.59	0.48	0.34	0.20	0.59	0.56	0.54	0.37	0.24	0.12	0.48	0.34	0.20	0.59	n/a	n/a	
	10 (254)	0.71	0.66	0.60	0.49	0.35	0.20	0.59	0.57	0.54	0.38	0.24	0.12	0.49	0.35	0.20	0.59	n/a	n/a	
	11 (279)	0.73	0.67	0.60	0.52	0.37	0.22	0.60	0.57	0.55	0.43	0.28	0.14	0.52	0.37	0.22	0.62	n/a	n/a	
	12 (305)	0.75	0.69	0.61	0.56	0.40	0.23	0.60	0.58	0.55	0.49	0.32	0.16	0.56	0.40	0.23	0.65	n/a	n/a	
	12-1/2 (318)	0.76	0.70	0.62	0.59	0.41	0.24	0.61	0.58	0.55	0.52	0.34	0.17	0.59	0.41	0.24	0.66	0.57	n/a	
	14 (356)	0.79	0.72	0.63	0.66	0.46	0.27	0.62	0.59	0.56	0.62	0.40	0.21	0.66	0.46	0.27	0.70	0.60	n/a	
	16 (406)	0.83	0.75	0.65	0.75	0.53	0.31	0.64	0.60	0.57	0.76	0.49	0.25	0.75	0.53	0.31	0.75	0.65	n/a	
	18 (457)	0.87	0.79	0.67	0.84	0.60	0.35	0.66	0.62	0.57	0.91	0.59	0.30	0.84	0.60	0.35	0.79	0.68	n/a	
	19-1/2 (495)	0.91	0.81	0.69	0.92	0.65	0.38	0.67	0.63	0.58	1.00	0.66	0.34	0.92	0.65	0.38	0.82	0.71	0.57	
	20 (508)	0.92	0.82	0.69	0.94	0.66	0.39	0.67	0.63	0.58		0.69	0.35	0.94	0.66	0.39	0.83	0.72	0.58	
	22 (559)	0.96	0.85	0.71	1.00	0.73	0.43	0.69	0.64	0.59		0.80	0.40	1.00	0.73	0.43	0.87	0.76	0.60	
	24 (610)	1.00	0.88	0.73		0.80	0.47	0.71	0.66	0.60		0.91	0.46		0.80	0.47	0.91	0.79	0.63	
	26 (660)		0.91	0.75		0.86	0.51	0.73	0.67	0.61		1.00	0.52		0.86	0.51	0.95	0.82	0.66	
28 (711)		0.94	0.77		0.93	0.54	0.74	0.68	0.62			0.58		0.93	0.54	0.99	0.85	0.68		
30 (762)		0.98	0.79		1.00	0.58	0.76	0.70	0.62			0.64		1.00	0.58	1.00	0.88	0.71		
36 (914)		1.00	0.84			0.70	0.81	0.73	0.65			0.85			0.70		0.97	0.77		
> 48 (1219)			0.96			0.93	0.92	0.81	0.70			1.00			0.93		1.00	0.89		

Table 17 - Load adjustment factors for #7 rebar in cracked concrete^{1,2,3}

#7 cracked concrete	Embedment h_{ef}	in. (mm)	Spacing factor in tension			Edge distance factor in tension			Spacing factor in shear ⁴			Edge distance in shear						Concrete thickness factor in shear ⁵		
			f_{AN}			f_{RN}			f_{AV}			f_{RV}			f_{RV}			f_{HV}		
			7-7/8 (200)	10-1/2 (267)	17-1/2 (445)	7-7/8 (200)	10-1/2 (267)	17-1/2 (445)	7-7/8 (200)	10-1/2 (267)	17-1/2 (445)	7-7/8 (200)	10-1/2 (267)	17-1/2 (445)	7-7/8 (200)	10-1/2 (267)	17-1/2 (445)	7-7/8 (200)	10-1/2 (267)	17-1/2 (445)
Spacing (s) / edge distance (c _e) / concrete thickness (h _c) - in. (mm)	1-3/4 (44)	n/a	n/a	n/a	0.43	0.41	0.38	n/a	n/a	n/a	0.03	0.02	0.01	0.06	0.04	0.02	n/a	n/a	n/a	
	4-3/8 (111)	0.59	0.57	0.54	0.55	0.50	0.44	0.54	0.53	0.52	0.11	0.07	0.03	0.22	0.14	0.07	n/a	n/a	n/a	
	5 (127)	0.60	0.58	0.55	0.58	0.52	0.45	0.54	0.53	0.52	0.13	0.09	0.04	0.27	0.17	0.08	n/a	n/a	n/a	
	6 (152)	0.62	0.60	0.56	0.64	0.56	0.47	0.55	0.54	0.52	0.18	0.11	0.05	0.35	0.23	0.11	n/a	n/a	n/a	
	7 (178)	0.65	0.61	0.57	0.69	0.60	0.49	0.56	0.55	0.53	0.22	0.14	0.07	0.44	0.29	0.13	n/a	n/a	n/a	
	8 (203)	0.67	0.63	0.58	0.75	0.64	0.52	0.57	0.55	0.53	0.27	0.18	0.08	0.54	0.35	0.16	n/a	n/a	n/a	
	9 (229)	0.69	0.64	0.59	0.81	0.68	0.54	0.58	0.56	0.54	0.32	0.21	0.10	0.65	0.42	0.20	n/a	n/a	n/a	
	9-7/8 (251)	0.71	0.66	0.59	0.86	0.72	0.56	0.59	0.56	0.54	0.37	0.24	0.11	0.74	0.48	0.22	0.59	n/a	n/a	
	10 (254)	0.71	0.66	0.60	0.87	0.73	0.56	0.59	0.57	0.54	0.38	0.25	0.11	0.76	0.49	0.23	0.59	n/a	n/a	
	11 (279)	0.73	0.67	0.60	0.93	0.77	0.59	0.60	0.57	0.54	0.44	0.28	0.13	0.87	0.57	0.26	0.62	n/a	n/a	
	12 (305)	0.75	0.69	0.61	1.00	0.82	0.61	0.60	0.58	0.55	0.50	0.32	0.15	1.00	0.65	0.30	0.65	n/a	n/a	
	12-1/2 (318)	0.76	0.70	0.62		0.84	0.62	0.61	0.58	0.55	0.53	0.34	0.16		0.69	0.32	0.66	0.57	n/a	
	14 (356)	0.79	0.72	0.63		0.91	0.66	0.62	0.59	0.55	0.63	0.41	0.19		0.82	0.38	0.70	0.61	n/a	
	16 (406)	0.83	0.75	0.65		1.00	0.71	0.64	0.60	0.56	0.77	0.50	0.23		1.00	0.46	0.75	0.65	n/a	
	18 (457)	0.87	0.79	0.67			0.76	0.66	0.62	0.57	0.91	0.59	0.28			0.55	0.79	0.69	n/a	
	19-1/2 (495)	0.91	0.81	0.69			0.80	0.67	0.63	0.58	1.00	0.67	0.31			0.62	0.82	0.71	0.55	
	20 (508)	0.92	0.82	0.69			0.82	0.67	0.63	0.58		0.70	0.32			0.65	0.84	0.72	0.56	
	22 (559)	0.96	0.85	0.71			0.87	0.69	0.64	0.59		0.80	0.37			0.75	0.88	0.76	0.59	
	24 (610)	1.00	0.88	0.73			0.93	0.71	0.66	0.59		0.91	0.43			0.85	0.92	0.79	0.61	
	26 (660)		0.91	0.75			0.99	0.73	0.67	0.60		1.00	0.48			0.96	0.95	0.82	0.64	
28 (711)		0.94	0.77			1.00	0.74	0.68	0.61			0.54			1.00	0.99	0.86	0.66		
30 (762)		0.98	0.79				0.76	0.70	0.62			0.59			1.00	0.89	0.69			
36 (914)		1.00	0.84				0.81	0.74	0.64			0.78				0.97	0.75			
> 48 (1219)			0.96				0.92	0.81	0.69			1.00				1.00	0.87			

- Linear interpolation not permitted.
- Shaded area with reduced edge distance is permitted provided the rebar has no installation torque.
- When combining multiple load adjustment factors (e.g. for a four-anchor pattern in a corner with thin concrete member) the design can become very conservative. To optimize the design, use Hilti PROFIS Anchor Design software or perform anchor calculation using design equations from ACI 318-14 Chapter 17.
- Spacing factor reduction in shear applicable when $c < 3 \cdot h_{ef}$. f_{AV} is applicable when edge distance, $c < 3 \cdot h_{ef}$. If $c \geq 3 \cdot h_{ef}$, then $f_{AV} = f_{AN}$.
- Concrete thickness reduction factor in shear, f_{HV} is applicable when edge distance, $c < 3 \cdot h_{ef}$. If $c \geq 3 \cdot h_{ef}$, then $f_{HV} = 1.0$.

Table 18 - Load adjustment factors for #8 rebar in uncracked concrete^{1,2,3}

Embedment h_{ef}	#8 uncracked concrete	Spacing factor in tension			Edge distance factor in tension			Spacing factor in shear ⁴			Edge distance in shear						Concrete thickness factor in shear ⁵		
		f_{AN}			f_{RN}			f_{AV}			f_{RV}			f_{RV}			f_{HV}		
		9	12	20	9	12	20	9	12	20	⊥ Toward edge			To and away from edge			9	12	20
in. (mm)	9 (229)	12 (305)	20 (508)	9 (229)	12 (305)	20 (508)	9 (229)	12 (305)	20 (508)	9 (229)	12 (305)	20 (508)	9 (229)	12 (305)	20 (508)	9 (229)	12 (305)	20 (508)	
1-3/4 (44)	n/a	n/a	n/a	0.24	0.17	0.10	n/a	n/a	n/a	0.02	0.01	0.01	0.05	0.03	0.01	n/a	n/a	n/a	
5 (127)	0.59	0.57	0.54	0.32	0.22	0.13	0.54	0.53	0.52	0.11	0.07	0.03	0.22	0.14	0.07	n/a	n/a	n/a	
6 (152)	0.61	0.58	0.55	0.34	0.24	0.14	0.55	0.53	0.52	0.14	0.09	0.04	0.29	0.19	0.09	n/a	n/a	n/a	
7 (178)	0.63	0.60	0.56	0.37	0.26	0.15	0.55	0.54	0.52	0.18	0.12	0.06	0.36	0.23	0.11	n/a	n/a	n/a	
8 (203)	0.65	0.61	0.57	0.40	0.28	0.16	0.56	0.55	0.53	0.22	0.14	0.07	0.40	0.28	0.14	n/a	n/a	n/a	
9 (229)	0.67	0.63	0.58	0.43	0.30	0.17	0.57	0.55	0.53	0.26	0.17	0.08	0.43	0.30	0.17	n/a	n/a	n/a	
10 (254)	0.68	0.64	0.58	0.46	0.32	0.19	0.58	0.56	0.54	0.31	0.20	0.10	0.46	0.32	0.19	n/a	n/a	n/a	
11 (279)	0.70	0.65	0.59	0.49	0.34	0.20	0.58	0.56	0.54	0.35	0.23	0.11	0.49	0.34	0.20	n/a	n/a	n/a	
11-1/4 (286)	0.71	0.66	0.59	0.50	0.34	0.20	0.59	0.56	0.54	0.37	0.24	0.12	0.50	0.34	0.20	0.58	n/a	n/a	
12 (305)	0.72	0.67	0.60	0.52	0.36	0.21	0.59	0.57	0.54	0.40	0.26	0.13	0.52	0.36	0.21	0.60	n/a	n/a	
13 (330)	0.74	0.68	0.61	0.55	0.38	0.22	0.60	0.57	0.55	0.46	0.30	0.14	0.55	0.38	0.22	0.63	n/a	n/a	
14 (356)	0.76	0.69	0.62	0.59	0.41	0.24	0.61	0.58	0.55	0.51	0.33	0.16	0.59	0.41	0.24	0.65	n/a	n/a	
14-1/4 (362)	0.76	0.70	0.62	0.60	0.42	0.24	0.61	0.58	0.55	0.52	0.34	0.16	0.60	0.42	0.24	0.66	0.57	n/a	
16 (406)	0.79	0.72	0.63	0.67	0.47	0.27	0.62	0.59	0.56	0.62	0.40	0.20	0.67	0.47	0.27	0.70	0.60	n/a	
18 (457)	0.83	0.75	0.65	0.76	0.53	0.31	0.64	0.60	0.56	0.74	0.48	0.23	0.76	0.53	0.31	0.74	0.64	n/a	
20 (508)	0.87	0.78	0.67	0.84	0.58	0.34	0.65	0.61	0.57	0.87	0.56	0.27	0.84	0.58	0.34	0.78	0.67	n/a	
22 (559)	0.90	0.81	0.68	0.93	0.64	0.38	0.67	0.63	0.58	1.00	0.65	0.32	0.93	0.64	0.38	0.82	0.71	n/a	
22-1/4 (565)	0.91	0.81	0.69	0.94	0.65	0.38	0.67	0.63	0.58		0.66	0.32	0.94	0.65	0.38	0.82	0.71	0.56	
24 (610)	0.94	0.83	0.70	1.00	0.70	0.41	0.68	0.64	0.58		0.74	0.36	1.00	0.70	0.41	0.85	0.74	0.58	
26 (660)	0.98	0.86	0.72		0.76	0.45	0.70	0.65	0.59		0.84	0.41		0.76	0.45	0.89	0.77	0.60	
28 (711)	1.00	0.89	0.73		0.82	0.48	0.71	0.66	0.60		0.94	0.45		0.82	0.48	0.92	0.80	0.63	
30 (762)		0.92	0.75		0.88	0.51	0.73	0.67	0.61		1.00	0.50		0.88	0.51	0.95	0.83	0.65	
36 (914)		1.00	0.80		1.00	0.62	0.77	0.70	0.63			0.66		1.00	0.62	1.00	0.91	0.71	
> 48 (1219)			0.90			0.82	0.86	0.77	0.67			1.00			0.82		1.00	0.82	

3.2.3

Table 19 - Load adjustment factors for #8 rebar in cracked concrete^{1,2,3}

Embedment h_{ef}	#8 cracked concrete	Spacing factor in tension			Edge distance factor in tension			Spacing factor in shear ⁴			Edge distance in shear						Concrete thickness factor in shear ⁵		
		f_{AN}			f_{RN}			f_{AV}			f_{RV}			f_{RV}			f_{HV}		
		9	12	20	9	12	20	9	12	20	⊥ Toward edge			To and away from edge			9	12	20
in. (mm)	9 (229)	12 (305)	20 (508)	9 (229)	12 (305)	20 (508)	9 (229)	12 (305)	20 (508)	9 (229)	12 (305)	20 (508)	9 (229)	12 (305)	20 (508)	9 (229)	12 (305)	20 (508)	
1-3/4 (44)	n/a	n/a	n/a	0.42	0.40	0.38	n/a	n/a	n/a	0.02	0.01	0.01	0.05	0.03	0.01	n/a	n/a	n/a	
5 (127)	0.59	0.57	0.54	0.55	0.50	0.44	0.54	0.53	0.52	0.11	0.07	0.03	0.22	0.14	0.07	n/a	n/a	n/a	
6 (152)	0.61	0.58	0.55	0.60	0.53	0.46	0.55	0.53	0.52	0.14	0.09	0.04	0.29	0.19	0.09	n/a	n/a	n/a	
7 (178)	0.63	0.60	0.56	0.65	0.57	0.47	0.55	0.54	0.52	0.18	0.12	0.05	0.36	0.24	0.11	n/a	n/a	n/a	
8 (203)	0.65	0.61	0.57	0.70	0.60	0.49	0.56	0.55	0.53	0.22	0.14	0.07	0.44	0.29	0.13	n/a	n/a	n/a	
9 (229)	0.67	0.63	0.58	0.75	0.64	0.51	0.57	0.55	0.53	0.26	0.17	0.08	0.53	0.34	0.16	n/a	n/a	n/a	
10 (254)	0.68	0.64	0.58	0.80	0.67	0.53	0.58	0.56	0.53	0.31	0.20	0.09	0.62	0.40	0.19	n/a	n/a	n/a	
11 (279)	0.70	0.65	0.59	0.85	0.71	0.55	0.58	0.56	0.54	0.36	0.23	0.11	0.72	0.46	0.22	n/a	n/a	n/a	
11-1/4 (286)	0.71	0.66	0.59	0.87	0.72	0.56	0.59	0.56	0.54	0.37	0.24	0.11	0.74	0.48	0.22	0.59	n/a	n/a	
12 (305)	0.72	0.67	0.60	0.91	0.75	0.57	0.59	0.57	0.54	0.41	0.26	0.12	0.82	0.53	0.25	0.61	n/a	n/a	
13 (330)	0.74	0.68	0.61	0.96	0.79	0.59	0.60	0.57	0.54	0.46	0.30	0.14	0.92	0.60	0.28	0.63	n/a	n/a	
14 (356)	0.76	0.69	0.62	1.00	0.83	0.62	0.61	0.58	0.55	0.51	0.33	0.16	1.00	0.67	0.31	0.65	n/a	n/a	
14-1/4 (362)	0.76	0.70	0.62		0.84	0.62	0.61	0.58	0.55	0.53	0.34	0.16		0.69	0.32	0.66	0.57	n/a	
16 (406)	0.79	0.72	0.63		0.91	0.66	0.62	0.59	0.55	0.63	0.41	0.19		0.82	0.38	0.70	0.61	n/a	
18 (457)	0.83	0.75	0.65		1.00	0.70	0.64	0.60	0.56	0.75	0.49	0.23		0.97	0.45	0.74	0.64	n/a	
20 (508)	0.87	0.78	0.67			0.75	0.65	0.61	0.57	0.88	0.57	0.26		1.00	0.53	0.78	0.68	n/a	
22 (559)	0.90	0.81	0.68			0.80	0.67	0.63	0.58	1.00	0.66	0.31			0.61	0.82	0.71	n/a	
22-1/4 (565)	0.91	0.81	0.69			0.80	0.67	0.63	0.58		0.67	0.31			0.62	0.82	0.71	0.55	
24 (610)	0.94	0.83	0.70			0.85	0.68	0.64	0.58		0.75	0.35			0.70	0.86	0.74	0.57	
26 (660)	0.98	0.86	0.72			0.90	0.70	0.65	0.59		0.84	0.39			0.78	0.89	0.77	0.60	
28 (711)	1.00	0.89	0.73			0.95	0.71	0.66	0.60		0.94	0.44			0.88	0.92	0.80	0.62	
30 (762)		0.92	0.75			1.00	0.73	0.67	0.60		1.00	0.49			0.97	0.96	0.83	0.64	
36 (914)		1.00	0.80				0.77	0.71	0.62			0.64			1.00	1.00	0.91	0.70	
> 48 (1219)			0.90				0.87	0.77	0.66			0.98				1.00	0.81		

- Linear interpolation not permitted.
- Shaded area with reduced edge distance is permitted provided the rebar has no installation torque.
- When combining multiple load adjustment factors (e.g. for a four-anchor pattern in a corner with thin concrete member) the design can become very conservative. To optimize the design, use Hilti PROFIS Anchor Design software or perform anchor calculation using design equations from ACI 318-14 Chapter 17.
- Spacing factor reduction in shear applicable when $c < 3 \cdot h_{ef}$. f_{AV} is applicable when edge distance, $c < 3 \cdot h_{ef}$. If $c \geq 3 \cdot h_{ef}$, then $f_{AV} = f_{AN}$.
- Concrete thickness reduction factor in shear, f_{HV} is applicable when edge distance, $c < 3 \cdot h_{ef}$. If $c \geq 3 \cdot h_{ef}$, then $f_{HV} = 1.0$.

Table 20 - Load adjustment factors for #9 rebar in uncracked concrete^{1,2,3}

#9 uncracked concrete	Embedment h_{ef}	in. (mm)	Spacing factor in tension			Edge distance factor in tension			Spacing factor in shear ⁴			Edge distance in shear						Concrete thickness factor in shear ⁵		
			f_{AN}			f_{RN}			f_{AV}			⊥ Toward edge			∥ To and away from edge			f_{HV}		
			10-1/8 (257)	13-1/2 (343)	22-1/2 (572)	10-1/8 (257)	13-1/2 (343)	22-1/2 (572)	10-1/8 (257)	13-1/2 (343)	22-1/2 (572)	10-1/8 (257)	13-1/2 (343)	22-1/2 (572)	10-1/8 (257)	13-1/2 (343)	22-1/2 (572)	10-1/8 (257)	13-1/2 (343)	22-1/2 (572)
Spacing (s) / edge distance (c _e) / concrete thickness (h _c) - in. (mm)	1-3/4 (44)	n/a	n/a	n/a	0.24	0.17	0.10	n/a	n/a	n/a	0.02	0.01	0.01	0.04	0.02	0.01	n/a	n/a	n/a	
	5-5/8 (143)	0.59	0.57	0.54	0.33	0.23	0.13	0.54	0.53	0.52	0.11	0.07	0.03	0.22	0.14	0.07	n/a	n/a	n/a	
	6 (152)	0.60	0.57	0.54	0.33	0.23	0.13	0.54	0.53	0.52	0.12	0.08	0.04	0.24	0.16	0.07	n/a	n/a	n/a	
	7 (178)	0.61	0.59	0.55	0.36	0.25	0.14	0.55	0.54	0.52	0.15	0.10	0.05	0.30	0.20	0.09	n/a	n/a	n/a	
	8 (203)	0.63	0.60	0.56	0.38	0.27	0.15	0.55	0.54	0.52	0.18	0.12	0.06	0.37	0.24	0.11	n/a	n/a	n/a	
	9 (229)	0.65	0.61	0.57	0.41	0.28	0.16	0.56	0.55	0.53	0.22	0.14	0.07	0.41	0.28	0.13	n/a	n/a	n/a	
	10 (254)	0.66	0.62	0.57	0.44	0.30	0.17	0.57	0.55	0.53	0.26	0.17	0.08	0.44	0.30	0.16	n/a	n/a	n/a	
	11 (279)	0.68	0.64	0.58	0.46	0.32	0.18	0.57	0.56	0.53	0.30	0.19	0.09	0.46	0.32	0.18	n/a	n/a	n/a	
	12 (305)	0.70	0.65	0.59	0.49	0.34	0.20	0.58	0.56	0.54	0.34	0.22	0.10	0.49	0.34	0.20	n/a	n/a	n/a	
	12-7/8 (327)	0.71	0.66	0.60	0.52	0.36	0.21	0.59	0.57	0.54	0.38	0.24	0.11	0.52	0.36	0.21	0.59	n/a	n/a	
	13 (330)	0.71	0.66	0.60	0.52	0.36	0.21	0.59	0.57	0.54	0.38	0.25	0.12	0.52	0.36	0.21	0.59	n/a	n/a	
	14 (356)	0.73	0.67	0.60	0.55	0.38	0.22	0.59	0.57	0.54	0.43	0.28	0.13	0.55	0.38	0.22	0.61	n/a	n/a	
	16 (406)	0.76	0.70	0.62	0.62	0.43	0.25	0.61	0.58	0.55	0.52	0.34	0.16	0.62	0.43	0.25	0.66	n/a	n/a	
	16-1/4 (413)	0.77	0.70	0.62	0.63	0.43	0.25	0.61	0.58	0.55	0.53	0.35	0.16	0.63	0.43	0.25	0.66	0.57	n/a	
	18 (457)	0.80	0.72	0.63	0.69	0.48	0.28	0.62	0.59	0.55	0.62	0.40	0.19	0.69	0.48	0.28	0.70	0.60	n/a	
	20 (508)	0.83	0.75	0.65	0.77	0.54	0.31	0.63	0.60	0.56	0.73	0.47	0.22	0.77	0.54	0.31	0.73	0.64	n/a	
	22 (559)	0.86	0.77	0.66	0.85	0.59	0.34	0.65	0.61	0.57	0.84	0.55	0.25	0.85	0.59	0.34	0.77	0.67	n/a	
	24 (610)	0.89	0.80	0.68	0.93	0.64	0.37	0.66	0.62	0.57	0.96	0.62	0.29	0.93	0.64	0.37	0.80	0.70	n/a	
	25-1/4 (641)	0.91	0.81	0.69	0.97	0.68	0.39	0.67	0.63	0.58	1.00	0.67	0.31	0.97	0.68	0.39	0.83	0.71	0.55	
	26 (660)	0.93	0.82	0.69	1.00	0.70	0.40	0.68	0.63	0.58		0.70	0.33	1.00	0.70	0.40	0.84	0.73	0.56	
28 (711)	0.96	0.85	0.71		0.75	0.43	0.69	0.64	0.59		0.78	0.36		0.75	0.43	0.87	0.75	0.58		
30 (762)	0.99	0.87	0.72		0.80	0.46	0.70	0.65	0.59		0.87	0.40		0.80	0.46	0.90	0.78	0.60		
36 (914)	1.00	0.94	0.77		0.96	0.55	0.74	0.68	0.61		1.00	0.53		0.96	0.55	0.99	0.85	0.66		
> 48 (1219)		1.00	0.86		1.00	0.74	0.82	0.74	0.65			0.82		1.00	0.74	1.00	0.99	0.76		

Table 21 - Load adjustment factors for #9 rebar in cracked concrete^{1,2,3}

#9 cracked concrete	Embedment h_{ef}	in. (mm)	Spacing factor in tension			Edge distance factor in tension			Spacing factor in shear ⁴			Edge distance in shear						Concrete thickness factor in shear ⁵		
			f_{AN}			f_{RN}			f_{AV}			⊥ Toward edge			∥ To and away from edge			f_{HV}		
			10-1/8 (257)	13-1/2 (343)	22-1/2 (572)	10-1/8 (257)	13-1/2 (343)	22-1/2 (572)	10-1/8 (257)	13-1/2 (343)	22-1/2 (572)	10-1/8 (257)	13-1/2 (343)	22-1/2 (572)	10-1/8 (257)	13-1/2 (343)	22-1/2 (572)	10-1/8 (257)	13-1/2 (343)	22-1/2 (572)
Spacing (s) / edge distance (c _e) / concrete thickness (h _c) - in. (mm)	1-3/4 (44)	n/a	n/a	n/a	0.41	0.39	0.38	n/a	n/a	n/a	0.02	0.01	0.01	0.04	0.02	0.01	n/a	n/a	n/a	
	5-5/8 (143)	0.59	0.57	0.54	0.56	0.50	0.44	0.54	0.53	0.52	0.11	0.07	0.03	0.22	0.14	0.07	n/a	n/a	n/a	
	6 (152)	0.60	0.57	0.54	0.57	0.51	0.44	0.54	0.53	0.52	0.12	0.08	0.04	0.24	0.16	0.07	n/a	n/a	n/a	
	7 (178)	0.61	0.59	0.55	0.61	0.54	0.46	0.55	0.54	0.52	0.15	0.10	0.05	0.30	0.20	0.09	n/a	n/a	n/a	
	8 (203)	0.63	0.60	0.56	0.65	0.57	0.48	0.55	0.54	0.52	0.19	0.12	0.06	0.37	0.24	0.11	n/a	n/a	n/a	
	9 (229)	0.65	0.61	0.57	0.70	0.60	0.49	0.56	0.55	0.53	0.22	0.14	0.07	0.44	0.29	0.13	n/a	n/a	n/a	
	10 (254)	0.66	0.62	0.57	0.74	0.63	0.51	0.57	0.55	0.53	0.26	0.17	0.08	0.52	0.34	0.16	n/a	n/a	n/a	
	11 (279)	0.68	0.64	0.58	0.79	0.67	0.53	0.57	0.56	0.53	0.30	0.19	0.09	0.60	0.39	0.18	n/a	n/a	n/a	
	12 (305)	0.70	0.65	0.59	0.84	0.70	0.55	0.58	0.56	0.54	0.34	0.22	0.10	0.68	0.44	0.21	n/a	n/a	n/a	
	12-7/8 (327)	0.71	0.66	0.60	0.88	0.73	0.56	0.59	0.57	0.54	0.38	0.25	0.11	0.76	0.49	0.23	0.59	n/a	n/a	
	13 (330)	0.71	0.66	0.60	0.89	0.73	0.56	0.59	0.57	0.54	0.39	0.25	0.12	0.77	0.50	0.23	0.59	n/a	n/a	
	14 (356)	0.73	0.67	0.60	0.94	0.77	0.58	0.60	0.57	0.54	0.43	0.28	0.13	0.86	0.56	0.26	0.62	n/a	n/a	
	16 (406)	0.76	0.70	0.62	1.00	0.84	0.62	0.61	0.58	0.55	0.53	0.34	0.16	1.00	0.68	0.32	0.66	n/a	n/a	
	16-1/4 (413)	0.77	0.70	0.62	1.00	0.85	0.63	0.61	0.58	0.55	0.54	0.35	0.16	1.00	0.70	0.32	0.66	0.58	n/a	
	18 (457)	0.80	0.72	0.63	1.00	0.91	0.66	0.62	0.59	0.55	0.63	0.41	0.19	1.00	0.82	0.38	0.70	0.61	n/a	
	20 (508)	0.83	0.75	0.65	1.00	0.99	0.70	0.64	0.60	0.56	0.73	0.48	0.22	1.00	0.95	0.44	0.74	0.64	n/a	
	22 (559)	0.86	0.77	0.66	1.00	1.00	0.74	0.65	0.61	0.57	0.85	0.55	0.26	1.00	1.00	0.51	0.77	0.67	n/a	
	24 (610)	0.89	0.80	0.68	1.00	1.00	0.78	0.66	0.62	0.57	0.97	0.63	0.29	1.00	1.00	0.58	0.81	0.70	n/a	
	25-1/4 (641)	0.91	0.81	0.69	1.00	1.00	0.81	0.67	0.63	0.58	1.00	0.68	0.31	1.00	1.00	0.63	0.83	0.72	0.56	
	26 (660)	0.93	0.82	0.69	1.00	1.00	0.82	0.68	0.63	0.58	1.00	0.71	0.33	1.00	1.00	0.66	0.84	0.73	0.56	
28 (711)	0.96	0.85	0.71	1.00	1.00	0.87	0.69	0.64	0.59	1.00	0.79	0.37	1.00	1.00	0.73	0.87	0.76	0.58		
30 (762)	0.99	0.87	0.72	1.00	1.00	0.91	0.70	0.65	0.59	1.00	0.88	0.41	1.00	1.00	0.82	0.90	0.78	0.61		
36 (914)	1.00	0.94	0.77	1.00	1.00	1.00	0.74	0.68	0.61	1.00	1.00	0.54	1.00	1.00	1.00	0.99	0.86	0.66		
> 48 (1219)		1.00	0.86	1.00	1.00	1.00	0.83	0.74	0.65	1.00	1.00	0.82	1.00	1.00	1.00	1.00	0.99	0.77		

1 Linear interpolation not permitted.

2 Shaded area with reduced edge distance is permitted provided the rebar has no installation torque.

3 When combining multiple load adjustment factors (e.g. for a four-anchor pattern in a corner with thin concrete member) the design can become very conservative. To optimize the design, use Hilti PROFIS Anchor Design software or perform anchor calculation using design equations from ACI 318-14 Chapter 17.

4 Spacing factor reduction in shear applicable when $c < 3 \cdot h_{ef}$. f_{AV} is applicable when edge distance, $c < 3 \cdot h_{ef}$. If $c \geq 3 \cdot h_{ef}$, then $f_{AV} = f_{AN}$.

5 Concrete thickness reduction factor in shear, f_{HV} is applicable when edge distance, $c < 3 \cdot h_{ef}$. If $c \geq 3 \cdot h_{ef}$, then $f_{HV} = 1.0$.

Table 22 - Load adjustment factors for #10 rebar in uncracked concrete^{1,2,3}

Embedment h_{ef}	in. (mm)	Spacing factor in tension f_{AN}			Edge distance factor in tension f_{RN}			Spacing factor in shear ⁴ f_{AV}			Edge distance in shear						Concrete thickness factor in shear ⁵ f_{HV}		
		11-1/4 (286)	15 (381)	25 (635)	11-1/4 (286)	15 (381)	25 (635)	11-1/4 (286)	15 (381)	25 (635)	⊥ Toward edge f_{RV}			To and away from edge f_{RV}			11-1/4 (286)	15 (381)	25 (635)
		11-1/4	15	25	11-1/4	15	25	11-1/4	15	25	11-1/4	15	25	11-1/4	15	25	11-1/4	15	25
1-3/4	(44)	n/a	n/a	n/a	0.24	0.17	0.09	n/a	n/a	n/a	0.02	0.01	0.00	0.03	0.02	0.01	n/a	n/a	n/a
6-1/4	(159)	0.59	0.57	0.54	0.33	0.23	0.13	0.54	0.53	0.52	0.11	0.07	0.03	0.22	0.14	0.07	n/a	n/a	n/a
7	(178)	0.60	0.58	0.55	0.35	0.24	0.14	0.54	0.53	0.52	0.13	0.08	0.04	0.26	0.17	0.08	n/a	n/a	n/a
8	(203)	0.62	0.59	0.55	0.37	0.26	0.15	0.55	0.54	0.52	0.16	0.10	0.05	0.31	0.20	0.10	n/a	n/a	n/a
9	(229)	0.63	0.60	0.56	0.39	0.27	0.15	0.55	0.54	0.52	0.19	0.12	0.06	0.38	0.24	0.11	n/a	n/a	n/a
10	(254)	0.65	0.61	0.57	0.42	0.29	0.16	0.56	0.55	0.53	0.22	0.14	0.07	0.42	0.29	0.13	n/a	n/a	n/a
11	(279)	0.66	0.62	0.57	0.44	0.31	0.17	0.57	0.55	0.53	0.25	0.16	0.08	0.44	0.31	0.15	n/a	n/a	n/a
12	(305)	0.68	0.63	0.58	0.47	0.32	0.18	0.57	0.55	0.53	0.29	0.19	0.09	0.47	0.32	0.17	n/a	n/a	n/a
13	(330)	0.69	0.64	0.59	0.49	0.34	0.19	0.58	0.56	0.54	0.33	0.21	0.10	0.49	0.34	0.19	n/a	n/a	n/a
14	(356)	0.71	0.66	0.59	0.52	0.36	0.20	0.59	0.56	0.54	0.36	0.24	0.11	0.52	0.36	0.20	n/a	n/a	n/a
14-1/4	(362)	0.71	0.66	0.60	0.52	0.36	0.21	0.59	0.56	0.54	0.37	0.24	0.11	0.52	0.36	0.21	0.59	n/a	n/a
15	(381)	0.72	0.67	0.60	0.54	0.38	0.21	0.59	0.57	0.54	0.40	0.26	0.12	0.54	0.38	0.21	0.60	n/a	n/a
16	(406)	0.74	0.68	0.61	0.57	0.40	0.22	0.60	0.57	0.54	0.45	0.29	0.13	0.57	0.40	0.22	0.62	n/a	n/a
17	(432)	0.75	0.69	0.61	0.60	0.42	0.24	0.60	0.58	0.55	0.49	0.32	0.15	0.60	0.42	0.24	0.64	n/a	n/a
18	(457)	0.77	0.70	0.62	0.64	0.44	0.25	0.61	0.58	0.55	0.53	0.35	0.16	0.64	0.44	0.25	0.66	0.57	n/a
20	(508)	0.80	0.72	0.63	0.71	0.49	0.28	0.62	0.59	0.55	0.62	0.40	0.19	0.71	0.49	0.28	0.70	0.60	n/a
22	(559)	0.83	0.74	0.65	0.78	0.54	0.31	0.63	0.60	0.56	0.72	0.47	0.22	0.78	0.54	0.31	0.73	0.63	n/a
24	(610)	0.86	0.77	0.66	0.85	0.59	0.33	0.65	0.61	0.57	0.82	0.53	0.25	0.85	0.59	0.33	0.76	0.66	n/a
26	(660)	0.89	0.79	0.67	0.92	0.64	0.36	0.66	0.62	0.57	0.92	0.60	0.28	0.92	0.64	0.36	0.79	0.69	n/a
28	(711)	0.91	0.81	0.69	0.99	0.69	0.39	0.67	0.63	0.58	1.00	0.67	0.31	0.99	0.69	0.39	0.82	0.71	0.55
30	(762)	0.94	0.83	0.70	1.00	0.74	0.42	0.68	0.64	0.58		0.74	0.35	1.00	0.74	0.42	0.85	0.74	0.57
36	(914)	1.00	0.90	0.74		0.88	0.50	0.72	0.66	0.60		0.98	0.45		0.88	0.50	0.94	0.81	0.63
> 48	(1219)		1.00	0.82		1.00	0.67	0.79	0.72	0.63		1.00	0.70		1.00	0.67	1.00	0.94	0.72

3.2.3

Table 23 - Load adjustment factors for #10 rebar in cracked concrete^{1,2,3}

Embedment h_{ef}	in. (mm)	Spacing factor in tension f_{AN}			Edge distance factor in tension f_{RN}			Spacing factor in shear ⁴ f_{AV}			Edge distance in shear						Concrete thickness factor in shear ⁵ f_{HV}		
		11-1/4 (286)	15 (381)	25 (635)	11-1/4 (286)	15 (381)	25 (635)	11-1/4 (286)	15 (381)	25 (635)	⊥ Toward edge f_{RV}			To and away from edge f_{RV}			11-1/4 (286)	15 (381)	25 (635)
		11-1/4	15	25	11-1/4	15	25	11-1/4	15	25	11-1/4	15	25	11-1/4	15	25	11-1/4	15	25
1-3/4	(44)	n/a	n/a	n/a	0.40	0.39	0.37	n/a	n/a	n/a	0.02	0.01	0.00	0.03	0.02	0.01	n/a	n/a	n/a
6-1/4	(159)	0.59	0.57	0.54	0.56	0.50	0.44	0.54	0.53	0.52	0.11	0.07	0.03	0.22	0.14	0.07	n/a	n/a	n/a
7	(178)	0.60	0.58	0.55	0.58	0.52	0.45	0.54	0.53	0.52	0.13	0.08	0.04	0.26	0.17	0.08	n/a	n/a	n/a
8	(203)	0.62	0.59	0.55	0.62	0.55	0.46	0.55	0.54	0.52	0.16	0.10	0.05	0.32	0.21	0.10	n/a	n/a	n/a
9	(229)	0.63	0.60	0.56	0.66	0.57	0.48	0.55	0.54	0.52	0.19	0.12	0.06	0.38	0.25	0.11	n/a	n/a	n/a
10	(254)	0.65	0.61	0.57	0.70	0.60	0.49	0.56	0.55	0.53	0.22	0.14	0.07	0.44	0.29	0.13	n/a	n/a	n/a
11	(279)	0.66	0.62	0.57	0.74	0.63	0.51	0.57	0.55	0.53	0.26	0.17	0.08	0.51	0.33	0.15	n/a	n/a	n/a
12	(305)	0.68	0.63	0.58	0.78	0.66	0.53	0.57	0.55	0.53	0.29	0.19	0.09	0.58	0.38	0.18	n/a	n/a	n/a
13	(330)	0.69	0.64	0.59	0.82	0.69	0.54	0.58	0.56	0.54	0.33	0.21	0.10	0.66	0.43	0.20	n/a	n/a	n/a
14	(356)	0.71	0.66	0.59	0.87	0.72	0.56	0.59	0.56	0.54	0.37	0.24	0.11	0.73	0.48	0.22	n/a	n/a	n/a
14-1/4	(362)	0.71	0.66	0.60	0.88	0.73	0.56	0.59	0.57	0.54	0.38	0.25	0.11	0.75	0.49	0.23	0.59	n/a	n/a
15	(381)	0.72	0.67	0.60	0.91	0.75	0.57	0.59	0.57	0.54	0.41	0.26	0.12	0.82	0.53	0.25	0.61	n/a	n/a
16	(406)	0.74	0.68	0.61	0.96	0.78	0.59	0.60	0.57	0.54	0.45	0.29	0.14	0.90	0.58	0.27	0.63	n/a	n/a
17	(432)	0.75	0.69	0.61	1.00	0.81	0.61	0.60	0.58	0.55	0.49	0.32	0.15	0.98	0.64	0.30	0.64	n/a	n/a
18	(457)	0.77	0.70	0.62		0.85	0.62	0.61	0.58	0.55	0.54	0.35	0.16	1.00	0.70	0.32	0.66	0.57	n/a
20	(508)	0.80	0.72	0.63		0.91	0.66	0.62	0.59	0.55	0.63	0.41	0.19		0.82	0.38	0.70	0.61	n/a
22	(559)	0.83	0.74	0.65		0.98	0.69	0.63	0.60	0.56	0.72	0.47	0.22		0.94	0.44	0.73	0.63	n/a
24	(610)	0.86	0.77	0.66		1.00	0.73	0.65	0.61	0.57	0.82	0.54	0.25		1.00	0.50	0.77	0.66	n/a
26	(660)	0.89	0.79	0.67			0.77	0.66	0.62	0.57	0.93	0.60	0.28			0.56	0.80	0.69	n/a
28	(711)	0.91	0.81	0.69			0.81	0.67	0.63	0.58	1.00	0.68	0.31			0.63	0.83	0.72	0.55
30	(762)	0.94	0.83	0.70			0.85	0.68	0.64	0.58		0.75	0.35			0.70	0.86	0.74	0.57
36	(914)	1.00	0.90	0.74			0.97	0.72	0.66	0.60		0.98	0.46			0.91	0.94	0.81	0.63
> 48	(1219)		1.00	0.82			1.00	0.79	0.72	0.63		1.00	0.70			1.00	1.00	0.94	0.73

- Linear interpolation not permitted.
- Shaded area with reduced edge distance is permitted provided the rebar has no installation torque.
- When combining multiple load adjustment factors (e.g. for a four-anchor pattern in a corner with thin concrete edges) the design can become very conservative. To optimize the design, use Hilti PROFIS Anchor Design software or perform anchor calculation using design equations from ACI 318-14 Chapter 17.
- Spacing factor reduction in shear applicable when $c < 3 \cdot h_{ef}$. f_{AV} is applicable when edge distance, $c < 3 \cdot h_{ef}$. If $c \geq 3 \cdot h_{ef}$, then $f_{AV} = f_{AN}$.
- Concrete thickness reduction factor in shear, f_{HV} is applicable when edge distance, $c < 3 \cdot h_{ef}$. If $c \geq 3 \cdot h_{ef}$, then $f_{HV} = 1.0$.

HIT-RE 500 V3 adhesive with HAS threaded rod



Figure 4 - Hilti HAS threaded rod installation conditions

















Cracked or uncracked concrete	Permissible drilling methods	Permissible concrete conditions
  Cracked and uncracked concrete	 Hammer drilling with carbide-tipped drill bit	 Dry concrete  Water-saturated concrete  Water-filled holes  Submerged (underwater)
	 Hilti TE-CD or TE-YD hollow drill bit and VC 20/40 Vacuum  Diamond core drill bit with Hilti TE-YRT roughening tool 	 Dry concrete  Water-saturated concrete
 Uncracked concrete	 Diamond core drill bit	 Dry concrete  Water-saturated concrete

Table 24 - Hilti HAS threaded rod installation specifications



Setting information		Symbol	Units	Nominal rod diameter, d						
Nominal bit diameter		d_o	in.	3/8	1/2	5/8	3/4	7/8	1	1-1/4
Effective embedment	minimum	$h_{ef,min}$	in. (mm)	2-3/8 (60)	2-3/4 (70)	3-1/8 (79)	3-1/2 (89)	3-1/2 (89)	4 (102)	5 (127)
	maximum	$h_{ef,max}$	in. (mm)	7-1/2 (191)	10 (254)	12-1/2 (318)	15 (381)	17-1/2 (445)	20 (508)	25 (635)
Diameter of fixture hole	through-set		in.	1/2	5/8	13/16 ¹	15/16 ¹	1-1/8 ¹	1-1/4 ¹	1-1/2 ¹
	preset		in.	7/16	9/16	11/16	13/16	15/16	1-1/8	1-3/8
Installation torque		T_{inst}	ft-lb (Nm)	15 (20)	30 (40)	60 (80)	100 (136)	125 (169)	150 (203)	200 (271)
Minimum concrete thickness		h_{min}	in. (mm)	$h_{ef}+1-1/4$ ($h_{ef}+30$)			$h_{ef}+2d_o$			
Minimum edge distance ²		c_{min}	in. (mm)	1-7/8 (48)	2-1/2 (64)	3-1/8 (79)	3-3/4 (95)	4-3/8 (111)	5 (127)	6-1/4 (159)
Minimum anchor spacing		s_{min}	in. (mm)	1-7/8 (48)	2-1/2 (64)	3-1/8 (79)	3-3/4 (95)	4-3/8 (111)	5 (127)	6-1/4 (159)

Figure 4 - Hilti HAS threaded rods

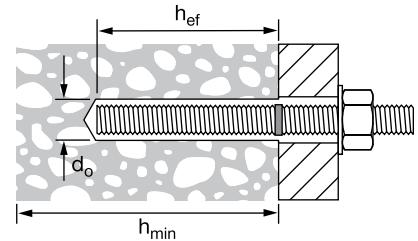

Figure 5 - Installation with (2) washers



1 Install using (2) washers. See Figure 5.

2 Edge distance of 1-3/4-inch (44mm) is permitted provided the installation torque is reduced to 0.30 T_{inst} for $5d < s < 16$ -in. and to $0.5T_{inst}$ for $s > 16$ -in.

Table 25 - Hilti HIT-RE 500 V3 adhesive design strength with concrete / bond failure for threaded rod in uncracked concrete^{1,2,3,4,5,6,7,8,9,11}

Nominal anchor diameter in.	Effective embedment in. (mm)	Tension — ΦN_n				Shear — ΦV_n			
		$f'_c = 2,500$ psi (17.2 MPa) lb (kN)	$f'_c = 3,000$ psi (20.7 MPa) lb (kN)	$f'_c = 4,000$ psi (27.6 MPa) lb (kN)	$f'_c = 6,000$ psi (41.4 MPa) lb (kN)	$f'_c = 2,500$ psi (17.2 MPa) lb (kN)	$f'_c = 3,000$ psi (20.7 MPa) lb (kN)	$f'_c = 4,000$ psi (27.6 MPa) lb (kN)	$f'_c = 6,000$ psi (41.4 MPa) lb (kN)
3/8	2-3/8 (60)	2,855 (12.7)	3,125 (13.9)	3,610 (16.1)	4,425 (19.7)	3,075 (13.7)	3,370 (15.0)	3,890 (17.3)	4,765 (21.2)
	3-3/8 (86)	4,835 (21.5)	5,300 (23.6)	6,115 (27.2)	7,490 (33.3)	10,415 (46.3)	11,410 (50.8)	13,175 (58.6)	16,135 (71.8)
	4-1/2 (114)	7,445 (33.1)	8,155 (36.3)	9,225 (41.0)	10,210 (45.4)	16,035 (71.3)	17,570 (78.2)	19,865 (88.4)	21,985 (97.8)
	7-1/2 (191)	13,670 (60.8)	14,305 (63.6)	15,375 (68.4)	17,015 (75.7)	29,440 (131.0)	30,815 (137.1)	33,110 (147.3)	36,645 (163.0)
1/2	2-3/4 (70)	3,555 (15.8)	3,895 (17.3)	4,500 (20.0)	5,510 (24.5)	7,660 (34.1)	8,395 (37.3)	9,690 (43.1)	11,870 (52.8)
	4-1/2 (114)	7,445 (33.1)	8,155 (36.3)	9,420 (41.9)	11,535 (51.3)	16,035 (71.3)	17,570 (78.2)	20,285 (90.2)	24,845 (110.5)
	6 (152)	11,465 (51.0)	12,560 (55.9)	14,500 (64.5)	17,535 (78.0)	24,690 (109.8)	27,045 (120.3)	31,230 (138.9)	37,775 (168.0)
	10 (254)	23,485 (104.5)	24,580 (109.3)	26,410 (117.5)	29,230 (130.0)	50,580 (225.0)	52,940 (235.5)	56,885 (253.0)	62,955 (280.0)
5/8 ¹⁰	3-1/8 (79)	4,310 (19.2)	4,720 (21.0)	5,450 (24.2)	6,675 (29.7)	9,280 (41.3)	10,165 (45.2)	11,740 (52.2)	14,380 (64.0)
	5-5/8 (143)	10,405 (46.3)	11,400 (50.7)	13,165 (58.6)	16,120 (71.7)	22,415 (99.7)	24,550 (109.2)	28,350 (126.1)	34,720 (154.4)
	7-1/2 (191)	16,020 (71.3)	17,550 (78.1)	20,265 (90.1)	24,820 (110.4)	34,505 (153.5)	37,800 (168.1)	43,650 (194.2)	53,455 (237.8)
	12-1/2 (318)	34,470 (153.3)	36,900 (164.1)	39,655 (176.4)	43,885 (195.2)	74,245 (330.3)	79,480 (353.5)	85,405 (379.9)	94,520 (420.4)
3/4 ¹⁰	3-1/2 (89)	5,105 (22.7)	5,595 (24.9)	6,460 (28.7)	7,910 (35.2)	11,000 (48.9)	12,050 (53.6)	13,915 (61.9)	17,040 (75.8)
	6-3/4 (171)	13,680 (60.9)	14,985 (66.7)	17,305 (77.0)	21,190 (94.3)	29,460 (131.0)	32,275 (143.6)	37,265 (165.8)	45,645 (203.0)
	9 (229)	21,060 (93.7)	23,070 (102.6)	26,640 (118.5)	32,625 (145.1)	45,360 (201.8)	49,690 (221.0)	57,375 (255.2)	70,270 (312.6)
	15 (381)	45,315 (201.6)	49,640 (220.8)	55,035 (244.8)	60,905 (270.9)	97,600 (434.1)	106,915 (475.6)	118,535 (527.3)	131,180 (583.5)
7/8 ¹⁰	3-1/2 (89)	5,105 (22.7)	5,595 (24.9)	6,460 (28.7)	7,910 (35.2)	11,000 (48.9)	12,050 (53.6)	13,915 (61.9)	17,040 (75.8)
	7-7/8 (200)	17,235 (76.7)	18,885 (84.0)	21,805 (97.0)	26,705 (118.8)	37,125 (165.1)	40,670 (180.9)	46,960 (208.9)	57,515 (255.8)
	10-1/2 (267)	26,540 (118.1)	29,070 (129.3)	33,570 (149.3)	41,115 (182.9)	57,160 (254.3)	62,615 (278.5)	72,300 (321.6)	88,550 (393.9)
	17-1/2 (445)	57,100 (254.0)	62,550 (278.2)	71,740 (319.1)	79,395 (353.2)	122,990 (547.1)	134,730 (599.3)	154,520 (687.3)	171,005 (760.7)
1 ¹⁰	4 (102)	6,240 (27.8)	6,835 (30.4)	7,895 (35.1)	9,665 (43.0)	13,440 (59.8)	14,725 (65.5)	17,000 (75.6)	20,820 (92.6)
	9 (229)	21,060 (93.7)	23,070 (102.6)	26,640 (118.5)	32,625 (145.1)	45,360 (201.8)	49,690 (221.0)	57,375 (255.2)	70,270 (312.6)
	12 (305)	32,425 (144.2)	35,520 (158.0)	41,015 (182.4)	50,230 (223.4)	69,835 (310.6)	76,500 (340.3)	88,335 (392.9)	108,190 (481.3)
	20 (508)	69,765 (310.3)	76,425 (340.0)	88,245 (392.5)	99,635 (443.2)	150,265 (668.4)	164,605 (732.2)	190,070 (845.5)	214,595 (954.6)
1-1/4 ¹⁰	5 (127)	8,720 (38.8)	9,555 (42.5)	11,030 (49.1)	13,510 (60.1)	18,785 (83.6)	20,575 (91.5)	23,760 (105.7)	29,100 (129.4)
	11-1/4 (286)	29,430 (130.9)	32,240 (143.4)	37,230 (165.6)	45,595 (202.8)	63,395 (282.0)	69,445 (308.9)	80,185 (356.7)	98,205 (436.8)
	15 (381)	45,315 (201.6)	49,640 (220.8)	57,320 (255.0)	70,200 (312.3)	97,600 (434.1)	106,915 (475.6)	123,455 (549.2)	151,200 (672.6)
	25 (635)	97,500 (433.7)	106,805 (475.1)	123,330 (548.6)	142,175 (632.4)	210,000 (934.1)	230,045 (1023.3)	265,630 (1181.6)	306,220 (1362.1)

3.2.3

- See Section 3.1.8 for explanation on development of load values.
- See Section 3.1.8 to convert design strength (factored resistance) value to ASD value.
- Linear interpolation between embedment depths and concrete compressive strengths is not permitted.
- Apply spacing, edge distance, and concrete thickness factors in Tables 30-41 as necessary to the above values. Compare to the steel values in Table 29. The lesser of the values is to be used for the design.
- Data is for temperature range A: Max. short term temperature = 130°F (55°C), max. long term temperature = 110°F (43°C). For temperature range B: Max. short term temperature = 176°F (80°C), max. long term temperature = 110°F (43°C) multiply above values by 0.69. Short term elevated concrete temperatures are those that occur over brief intervals, e.g., as a result of diurnal cycling. Long term concrete temperatures are roughly constant over significant periods of time.
- Tabular values are for dry or water saturated concrete conditions. For water-filled drilled holes multiply design strength by 0.51. For submerged (under water) applications multiply design strength by 0.45.
- Tabular values are for short term loads only. For sustained loads including overhead use, see Section 3.1.8.
- Tabular values are for normal-weight concrete only. For lightweight concrete multiply design strength (factored resistance) by λ_a as follows: For sand-lightweight, $\lambda_a = 0.51$. For all-lightweight, $\lambda_a = 0.45$.
- Tabular values are for holes drilled in concrete with carbide tipped hammer drill bit. For diamond core drilling, except as indicated in note 10, multiply above values by 0.55. Diamond core drilling is not permitted for water-filled or underwater (submerged) applications.
- Diamond core drilling with Hilti TE-YRT roughening tool is permitted for 5/8", 3/4", 7/8", 1", and 1 1/4" diameter anchors for dry and water-saturated concrete conditions. See Table 27.
- Tabular values are for static loads only. Seismic design is not permitted for uncracked concrete.

Table 26 - Hilti HIT-RE 500 V3 adhesive design strength with concrete / bond failure for threaded rod in cracked concrete^{1,2,3,4,5,6,7,8,9,11}

Nominal anchor diameter in.	Effective embedment in. (mm)	Tension — ΦN_n				Shear — ΦV_n			
		$f'_c = 2,500$ psi (17.2 MPa) lb (kN)	$f'_c = 3,000$ psi (20.7 MPa) lb (kN)	$f'_c = 4,000$ psi (27.6 MPa) lb (kN)	$f'_c = 6,000$ psi (41.4 MPa) lb (kN)	$f'_c = 2,500$ psi (17.2 MPa) lb (kN)	$f'_c = 3,000$ psi (20.7 MPa) lb (kN)	$f'_c = 4,000$ psi (27.6 MPa) lb (kN)	$f'_c = 6,000$ psi (41.4 MPa) lb (kN)
3/8	2-3/8 (60)	2,020 (9.0)	2,215 (9.9)	2,500 (11.1)	2,655 (11.8)	2,180 (9.7)	2,385 (10.6)	2,690 (12.0)	2,860 (12.7)
	3-3/8 (86)	3,310 (14.7)	3,400 (15.1)	3,550 (15.8)	3,770 (16.8)	7,125 (31.7)	7,325 (32.6)	7,645 (34.0)	8,125 (36.1)
	4-1/2 (114)	4,410 (19.6)	4,535 (20.2)	4,735 (21.1)	5,030 (22.4)	9,500 (42.3)	9,765 (43.4)	10,195 (45.3)	10,835 (48.2)
	7-1/2 (191)	7,350 (32.7)	7,555 (33.6)	7,890 (35.1)	8,385 (37.3)	15,835 (70.4)	16,275 (72.4)	16,990 (75.6)	18,055 (80.3)
1/2	2-3/4 (70)	2,520 (11.2)	2,760 (12.3)	3,185 (14.2)	3,905 (17.4)	5,425 (24.1)	5,945 (26.4)	6,865 (30.5)	8,405 (37.4)
	4-1/2 (114)	5,275 (23.5)	5,780 (25.7)	6,260 (27.8)	6,655 (29.6)	11,360 (50.5)	12,445 (55.4)	13,485 (60.0)	14,330 (63.7)
	6 (152)	7,780 (34.6)	7,995 (35.6)	8,350 (37.1)	8,870 (39.5)	16,755 (74.5)	17,220 (76.6)	17,980 (80.0)	19,110 (85.0)
	10 (254)	12,965 (57.7)	13,325 (59.3)	13,915 (61.9)	14,785 (65.8)	27,930 (124.2)	28,705 (127.7)	29,970 (133.3)	31,850 (141.7)
5/8 ¹⁰	3-1/8 (79)	3,050 (13.6)	3,345 (14.9)	3,860 (17.2)	4,730 (21.0)	6,575 (29.2)	7,200 (32.0)	8,315 (37.0)	10,185 (45.3)
	5-5/8 (143)	7,370 (32.8)	8,075 (35.9)	9,325 (41.5)	10,315 (45.9)	15,875 (70.6)	17,390 (77.4)	20,080 (89.3)	22,215 (98.8)
	7-1/2 (191)	11,350 (50.5)	12,395 (55.1)	12,940 (57.6)	13,755 (61.2)	24,440 (108.7)	26,695 (118.7)	27,875 (124.0)	29,620 (131.8)
	12-1/2 (318)	20,100 (89.4)	20,660 (91.9)	21,570 (95.9)	22,920 (102.0)	43,295 (192.6)	44,495 (197.9)	46,460 (206.7)	49,370 (219.6)
3/4 ¹⁰	3-1/2 (89)	3,620 (16.1)	3,965 (17.6)	4,575 (20.4)	5,605 (24.9)	7,790 (34.7)	8,535 (38.0)	9,855 (43.8)	12,070 (53.7)
	6-3/4 (171)	9,690 (43.1)	10,615 (47.2)	12,255 (54.5)	14,735 (65.5)	20,870 (92.8)	22,860 (101.7)	26,395 (117.4)	31,740 (141.2)
	9 (229)	14,920 (66.4)	16,340 (72.7)	18,490 (82.2)	19,650 (87.4)	32,130 (142.9)	35,195 (156.6)	39,820 (177.1)	42,320 (188.2)
	15 (381)	28,715 (127.7)	29,510 (131.3)	30,815 (137.1)	32,745 (145.7)	61,850 (275.1)	63,565 (282.7)	66,370 (295.2)	70,530 (313.7)
7/8 ¹⁰	3-1/2 (89)	3,620 (16.1)	3,965 (17.6)	4,575 (20.4)	5,605 (24.9)	7,790 (34.7)	8,535 (38.0)	9,855 (43.8)	12,070 (53.7)
	7-7/8 (200)	12,210 (54.3)	13,375 (59.5)	15,445 (68.7)	18,915 (84.1)	26,300 (117.0)	28,810 (128.2)	33,265 (148.0)	40,740 (181.2)
	10-1/2 (267)	18,800 (83.6)	20,590 (91.6)	23,780 (105.8)	26,530 (118.0)	40,490 (180.1)	44,355 (197.3)	51,215 (227.8)	57,140 (254.2)
	17-1/2 (445)	38,775 (172.5)	39,850 (177.3)	41,605 (185.1)	44,215 (196.7)	83,510 (371.5)	85,825 (381.8)	89,610 (399.6)	95,230 (423.6)
1 ¹⁰	4 (102)	4,420 (19.7)	4,840 (21.5)	5,590 (24.9)	6,845 (30.4)	9,520 (42.3)	10,430 (46.4)	12,040 (53.6)	14,750 (65.6)
	9 (229)	14,920 (66.4)	16,340 (72.7)	18,870 (83.9)	23,110 (102.8)	32,130 (142.9)	35,195 (156.6)	40,640 (180.8)	49,775 (221.4)
	12 (305)	22,965 (102.2)	25,160 (111.9)	29,050 (129.2)	34,650 (154.1)	49,465 (220.0)	54,190 (241.0)	62,570 (278.3)	74,630 (332.0)
	20 (508)	49,415 (219.8)	52,045 (231.5)	54,340 (241.7)	57,750 (256.9)	106,435 (473.4)	112,100 (498.6)	117,045 (520.6)	124,385 (553.3)
1-1/4 ¹⁰	5 (127)	6,175 (27.5)	6,765 (30.1)	7,815 (34.8)	9,570 (42.6)	13,305 (59.2)	14,575 (64.8)	16,830 (74.9)	20,610 (91.7)
	11-1/4 (286)	20,850 (92.7)	22,840 (101.6)	26,370 (117.3)	32,295 (143.7)	44,905 (199.7)	49,190 (218.8)	56,800 (252.7)	69,565 (309.4)
	15 (381)	32,095 (142.8)	35,160 (156.4)	40,600 (180.6)	49,725 (221.2)	69,135 (307.5)	75,730 (336.9)	87,445 (389.0)	107,100 (476.4)
	25 (635)	69,060 (307.2)	75,655 (336.5)	80,800 (359.4)	85,865 (381.9)	148,750 (661.7)	162,945 (724.8)	174,030 (774.1)	184,945 (822.7)

1 See Section 3.1.8 for explanation on development of load values.
2 See Section 3.1.8 to convert design strength value to ASD value.
3 Linear interpolation between embedment depths and concrete compressive strengths is not permitted.
4 Apply spacing, edge distance, and concrete thickness factors in tables 30-41 as necessary to the above values. Compare to the steel values in table 29. The lesser of the values is to be used for the design.
5 Data is for temperature range A: Max. short term temperature = 130°F (55°C), max. long term temperature = 110°F (43°C).
For temperature range B: Max. short term temperature = 176°F (80°C), max. long term temperature = 110°F (43°C) multiply above values by 0.69.
Short term elevated concrete temperatures are those that occur over brief intervals, e.g., as a result of diurnal cycling. Long term concrete temperatures are roughly constant over significant periods of time.
6 Tabular values are for dry or water saturated concrete conditions.
For water-filled drilled holes multiply design strength by 0.51.
For submerged (under water) applications multiply design strength by 0.44.
7 Tabular values are for short term loads only. For sustained loads including overhead use, see Section 3.1.8.
8 Tabular values are for normal-weight concrete only. For lightweight concrete multiply design strength by λ_{cs} as follows:
For sand-lightweight, $\lambda_{cs} = 0.51$. For all-lightweight, $\lambda_{cs} = 0.45$.
9 Tabular values are for holes drilled in concrete with carbide tipped hammer drill bit. Diamond core drilling is not permitted in cracked concrete conditions except as indicated in note 10.
10 Diamond core drilling with Hilti TE-YRT roughening tool is permitted for 5/8", 3/4", 7/8", 1", and 1 1/4" diameter anchors for dry and water-saturated concrete conditions. See Table 28
11 Tabular values are for static loads only. For seismic loads, multiply cracked concrete tabular values in tension and shear by α_{seis} indicated below.
See section 3.1.8 for additional information on seismic applications.
3/8-in. diameter - $\alpha_{seis} = 0.69$
1/2-in. diameter - $\alpha_{seis} = 0.70$
5/8-in. diameter - $\alpha_{seis} = 0.71$
3/4-in. diameter and larger - $\alpha_{seis} = 0.75$

Table 27 - Hilti HIT-RE 500 V3 for Core Drilled Holes with TE-YRT Roughening Tool adhesive design strength with concrete / bond failure for threaded rod in uncracked concrete^{1,2,3,4,5,6,7,8,9}

Nominal anchor diameter in.	Effective embedment in. (mm)	Tension — ΦN_n				Shear — ΦV_n			
		$f'_c = 2,500$ psi (17.2 MPa) lb (kN)	$f'_c = 3,000$ psi (20.7 MPa) lb (kN)	$f'_c = 4,000$ psi (27.6 MPa) lb (kN)	$f'_c = 6,000$ psi (41.4 MPa) lb (kN)	$f'_c = 2,500$ psi (17.2 MPa) lb (kN)	$f'_c = 3,000$ psi (20.7 MPa) lb (kN)	$f'_c = 4,000$ psi (27.6 MPa) lb (kN)	$f'_c = 6,000$ psi (41.4 MPa) lb (kN)
5/8	3-1/8 (79)	4,310 (19.2)	4,720 (21.0)	5,450 (24.2)	6,675 (29.7)	9,280 (41.3)	10,165 (45.2)	11,740 (52.2)	14,380 (64.0)
	5-5/8 (143)	10,405 (46.3)	11,400 (50.7)	13,165 (58.6)	15,865 (70.6)	22,415 (99.7)	24,550 (109.2)	28,350 (126.1)	34,170 (152.0)
	7-1/2 (191)	16,020 (71.3)	17,550 (78.1)	20,265 (90.1)	21,155 (94.1)	34,505 (153.5)	37,800 (168.1)	43,650 (194.2)	45,565 (202.7)
	12-1/2 (318)	34,470 (153.3)	35,255 (156.8)	35,255 (156.8)	35,255 (156.8)	74,245 (330.3)	75,940 (337.8)	75,940 (337.8)	75,940 (337.8)
3/4	3-1/2 (89)	5,105 (22.7)	5,595 (24.9)	6,460 (28.7)	7,910 (35.2)	11,000 (48.9)	12,050 (53.6)	13,915 (61.9)	17,040 (75.8)
	6-3/4 (171)	13,680 (60.9)	14,985 (66.7)	17,305 (77.0)	21,190 (94.3)	29,460 (131.0)	32,275 (143.6)	37,265 (165.8)	45,645 (203.0)
	9 (229)	21,060 (93.7)	23,070 (102.6)	26,640 (118.5)	29,360 (130.6)	45,360 (201.8)	49,690 (221.0)	57,375 (255.2)	63,235 (281.3)
	11-1/4 (286)	29,430 (130.9)	32,240 (143.4)	36,700 (163.2)	36,700 (163.2)	63,395 (282.0)	69,445 (308.9)	79,045 (351.6)	79,045 (351.6)
7/8	3-1/2 (89)	5,105 (22.7)	5,595 (24.9)	6,460 (28.7)	7,910 (35.2)	11,000 (48.9)	12,050 (53.6)	13,915 (61.9)	17,040 (75.8)
	7-7/8 (200)	17,235 (76.7)	18,885 (84.0)	21,805 (97.0)	26,705 (118.8)	37,125 (165.1)	40,670 (180.9)	46,960 (208.9)	57,515 (255.8)
	10-1/2 (267)	26,540 (118.1)	29,070 (129.3)	33,570 (149.3)	38,275 (170.3)	57,160 (254.3)	62,615 (278.5)	72,300 (321.6)	82,435 (366.7)
	17-1/2 (445)	57,100 (254.0)	62,550 (278.2)	63,790 (283.8)	63,790 (283.8)	122,990 (547.1)	134,730 (599.3)	137,390 (611.1)	137,390 (611.1)
1	4 (102)	6,240 (27.8)	6,835 (30.4)	7,895 (35.1)	9,665 (43.0)	13,440 (59.8)	14,725 (65.5)	17,000 (75.6)	20,820 (92.6)
	9 (229)	21,060 (93.7)	23,070 (102.6)	26,640 (118.5)	32,625 (145.1)	45,360 (201.8)	49,690 (221.0)	57,375 (255.2)	70,270 (312.6)
	12 (305)	32,425 (144.2)	35,520 (158.0)	41,015 (182.4)	48,030 (213.6)	69,835 (310.6)	76,500 (340.3)	88,335 (392.9)	103,445 (460.1)
	20 (508)	69,765 (310.3)	76,425 (340.0)	80,050 (356.1)	80,050 (356.1)	150,265 (668.4)	164,605 (732.2)	172,410 (766.9)	172,410 (766.9)
1-1/4	5 (127)	8,720 (38.8)	9,555 (42.5)	11,030 (49.1)	13,510 (60.1)	18,785 (83.6)	20,575 (91.5)	23,760 (105.7)	29,100 (129.4)
	11-1/4 (286)	29,430 (130.9)	32,240 (143.4)	37,230 (165.6)	45,595 (202.8)	63,395 (282.0)	69,445 (308.9)	80,185 (356.7)	98,205 (436.8)
	15 (381)	45,315 (201.6)	49,640 (220.8)	57,320 (255.0)	68,535 (304.9)	97,600 (434.1)	106,915 (475.6)	123,455 (549.2)	147,615 (656.6)
	25 (635)	97,500 (433.7)	106,805 (475.1)	114,225 (508.1)	114,225 (508.1)	210,000 (934.1)	230,045 (1023.3)	246,025 (1094.4)	246,025 (1094.4)

3.2.3

- 1 See Section 3.1.8 for explanation on development of load values.
- 2 See Section 3.1.8 to convert design strength value to ASD value.
- 3 Linear interpolation between embedment depths and concrete compressive strengths is not permitted.
- 4 Apply spacing, edge distance, and concrete thickness factors in tables 30-41 as necessary to the above values. Compare to the steel values in table 29. The lesser of the values is to be used for the design.
- 5 Data is for temperature range A: Max. short term temperature = 130°F (55°C), max. long term temperature = 110°F (43°C).
For temperature range B: Max. short term temperature = 176°F (80°C), max. long term temperature = 110°F (43°C) multiply above values by 0.69.
Short term elevated concrete temperatures are those that occur over brief intervals, e.g., as a result of diurnal cycling. Long term concrete temperatures are roughly constant over significant periods of time.
- 6 Tabular values are for dry or water saturated concrete conditions. Water-filled and submerged (under water) applications are not permitted for this hole preparation method.
- 7 Tabular values are for short term loads only. For sustained loads including overhead use, see Section 3.1.8.
- 8 Tabular values are for normal-weight concrete only. For lightweight concrete multiply design strength by λ_s as follows:
For sand-lightweight, $\lambda_s = 0.51$. For all-lightweight, $\lambda_s = 0.45$.
- 9 Tabular values are for static loads only. Seismic design is not permitted for uncracked concrete.

Table 28 - Hilti HIT-RE 500 V3 for Core Drilled Holes with TE-YRT Roughening Tool adhesive design strength with concrete / bond failure for threaded rod in cracked concrete^{1,2,3,4,5,6,7,8,9}

Nominal anchor diameter in.	Effective embedment in. (mm)	Tension — ΦN_n				Shear — ΦV_n			
		$f'_c = 2,500$ psi (17.2 MPa) lb (kN)	$f'_c = 3,000$ psi (20.7 MPa) lb (kN)	$f'_c = 4,000$ psi (27.6 MPa) lb (kN)	$f'_c = 6,000$ psi (41.4 MPa) lb (kN)	$f'_c = 2,500$ psi (17.2 MPa) lb (kN)	$f'_c = 3,000$ psi (20.7 MPa) lb (kN)	$f'_c = 4,000$ psi (27.6 MPa) lb (kN)	$f'_c = 6,000$ psi (41.4 MPa) lb (kN)
5/8	3-1/8 (79)	3,050 (13.6)	3,345 (14.9)	3,510 (15.6)	3,510 (15.6)	6,575 (29.2)	7,200 (32.0)	7,560 (33.6)	7,560 (33.6)
	5-5/8 (143)	6,320 (28.1)	6,320 (28.1)	6,320 (28.1)	6,320 (28.1)	13,605 (60.5)	13,605 (60.5)	13,605 (60.5)	13,605 (60.5)
	7-1/2 (191)	8,425 (37.5)	8,425 (37.5)	8,425 (37.5)	8,425 (37.5)	18,145 (80.7)	18,145 (80.7)	18,145 (80.7)	18,145 (80.7)
	12-1/2 (318)	14,040 (62.5)	14,040 (62.5)	14,040 (62.5)	14,040 (62.5)	30,240 (134.5)	30,240 (134.5)	30,240 (134.5)	30,240 (134.5)
3/4	3-1/2 (89)	3,620 (16.1)	3,965 (17.6)	4,575 (20.4)	4,690 (20.9)	7,790 (34.7)	8,535 (38.0)	9,855 (43.8)	10,100 (44.9)
	6-3/4 (171)	9,045 (40.2)	9,045 (40.2)	9,045 (40.2)	9,045 (40.2)	19,485 (86.7)	19,485 (86.7)	19,485 (86.7)	19,485 (86.7)
	9 (229)	12,060 (53.6)	12,060 (53.6)	12,060 (53.6)	12,060 (53.6)	25,975 (115.5)	25,975 (115.5)	25,975 (115.5)	25,975 (115.5)
	11-1/4 (286)	15,075 (67.1)	15,075 (67.1)	15,075 (67.1)	15,075 (67.1)	32,470 (144.4)	32,470 (144.4)	32,470 (144.4)	32,470 (144.4)
7/8	3-1/2 (89)	3,620 (16.1)	3,965 (17.6)	4,575 (20.4)	5,440 (24.2)	7,790 (34.7)	8,535 (38.0)	9,855 (43.8)	11,720 (52.1)
	7-7/8 (200)	12,210 (54.3)	12,240 (54.4)	12,240 (54.4)	12,240 (54.4)	26,300 (117.0)	26,365 (117.3)	26,365 (117.3)	26,365 (117.3)
	10-1/2 (267)	16,320 (72.6)	16,320 (72.6)	16,320 (72.6)	16,320 (72.6)	35,155 (156.4)	35,155 (156.4)	35,155 (156.4)	35,155 (156.4)
	17-1/2 (445)	27,205 (121.0)	27,205 (121.0)	27,205 (121.0)	27,205 (121.0)	58,595 (260.6)	58,595 (260.6)	58,595 (260.6)	58,595 (260.6)
1	4 (102)	4,420 (19.7)	4,840 (21.5)	5,590 (24.9)	6,845 (30.4)	9,520 (42.3)	10,430 (46.4)	12,040 (53.6)	14,750 (65.6)
	9 (229)	14,920 (66.4)	15,990 (71.1)	15,990 (71.1)	15,990 (71.1)	32,130 (142.9)	34,440 (153.2)	34,440 (153.2)	34,440 (153.2)
	12 (305)	21,320 (94.8)	21,320 (94.8)	21,320 (94.8)	21,320 (94.8)	45,920 (204.3)	45,920 (204.3)	45,920 (204.3)	45,920 (204.3)
	20 (508)	35,530 (158.0)	35,530 (158.0)	35,530 (158.0)	35,530 (158.0)	76,530 (340.4)	76,530 (340.4)	76,530 (340.4)	76,530 (340.4)
1-1/4	5 (127)	6,175 (27.5)	6,765 (30.1)	7,815 (34.8)	9,570 (42.6)	13,305 (59.2)	14,575 (64.8)	16,830 (74.9)	20,610 (91.7)
	11-1/4 (286)	20,850 (92.7)	22,840 (101.6)	23,690 (105.4)	23,690 (105.4)	44,905 (199.7)	49,190 (218.8)	51,025 (227.0)	51,025 (227.0)
	15 (381)	31,590 (140.5)	31,590 (140.5)	31,590 (140.5)	31,590 (140.5)	68,035 (302.6)	68,035 (302.6)	68,035 (302.6)	68,035 (302.6)
	25 (635)	52,645 (234.2)	52,645 (234.2)	52,645 (234.2)	52,645 (234.2)	113,390 (504.4)	113,390 (504.4)	113,390 (504.4)	113,390 (504.4)

1 See Section 3.1.8 for explanation on development of load values.

2 See Section 3.1.8 to convert design strength value to ASD value.

3 Linear interpolation between embedment depths and concrete compressive strengths is not permitted.

4 Apply spacing, edge distance, and concrete thickness factors in tables 30-41 as necessary to the above values. Compare to the steel values in table 29. The lesser of the values is to be used for the design.

5 Data is for temperature range A: Max. short term temperature = 130°F (55°C), max. long term temperature = 110°F (43°C).

For temperature range B: Max. short term temperature = 176°F (80°C), max. long term temperature = 110°F (43°C) multiply above values by 0.69.

Short term elevated concrete temperatures are those that occur over brief intervals, e.g., as a result of diurnal cycling. Long term concrete temperatures are roughly constant over significant periods of time.

6 Tabular values are for dry or water saturated concrete conditions. Water-filled and submerged (under water) applications are not permitted for this hole preparation method.

7 Tabular values are for short term loads only. For sustained loads including overhead use, see Section 3.1.8.

8 Tabular values are for normal-weight concrete only. For lightweight concrete multiply design strength by λ_a as follows:

For sand-lightweight, $\lambda_a = 0.51$. For all-lightweight, $\lambda_a = 0.45$.

9 Tabular values are for static loads only. Seismic design is not permitted for uncracked concrete. For seismic loads, multiply cracked concrete tabular values in tension and shear by $\alpha_{seis} = 0.75$. See section 3.1.8 for additional information on seismic applications.

Table 29 - Steel design strength for Hilti HAS threaded rods for use with ACI 318-14 Chapter 17

Nominal anchor diameter in.	HAS-V-36 / HAS-V-36 HDG ASTM F1554 Gr.36 ^{4,6}			HAS-E-55 / HAS-E-55 HDG ASTM F1554 Gr. 55 ^{4,5,6}			HAS-B-105 / HAS-B-105 HDG ASTM A193 B7 and ASTM F 1554 Gr.105 ^{4,6}			HAS-R stainless steel ASTM F593 (3/8-in to 1-in) ⁵ ASTM A193 (1-1/8-in to 2-in) ⁴		
	Tensile ¹ ΦN_{sa} lb (kN)	Shear ² ΦV_{sa} lb (kN)	Seismic Shear ³ $\Phi V_{sa,eq}$ lb (kN)	Tensile ¹ ΦN_{sa} lb (kN)	Shear ² ΦV_{sa} lb (kN)	Seismic Shear ³ $\Phi V_{sa,eq}$ lb (kN)	Tensile ¹ ΦN_{sa} lb (kN)	Shear ² ΦV_{sa} lb (kN)	Seismic Shear ³ $\Phi V_{sa,eq}$ lb (kN)	Tensile ¹ ΦN_{sa} lb (kN)	Shear ² ΦV_{sa} lb (kN)	Seismic Shear ³ $\Phi V_{sa,eq}$ lb (kN)
3/8	3,370 (15.0)	1,750 (7.8)	1,050 (4.7)	4,360 (19.4)	2,270 (10.1)	2,270 (10.1)	7,270 (32.3)	3,780 (16.8)	3,780 (16.8)	5,040 (22.4)	2,790 (12.4)	2,230 (9.9)
1/2	6,175 (27.5)	3,210 (14.3)	1,925 (8.6)	7,985 (35.5)	4,150 (18.5)	4,150 (18.5)	13,305 (59.2)	6,920 (30.8)	6,920 (30.8)	9,225 (41.0)	5,110 (22.7)	4,090 (18.2)
5/8	9,835 (43.7)	5,110 (22.7)	3,065 (13.6)	12,715 (56.6)	6,610 (29.4)	6,610 (29.4)	21,190 (94.3)	11,020 (49.0)	11,020 (49.0)	14,690 (65.3)	8,135 (36.2)	6,510 (29.0)
3/4	14,550 (64.7)	7,565 (33.7)	4,540 (20.2)	18,820 (83.7)	9,785 (43.5)	9,785 (43.5)	31,360 (139.5)	16,310 (72.6)	16,310 (72.6)	18,485 (82.2)	10,235 (45.5)	8,190 (36.4)
7/8	20,085 (89.3)	10,445 (46.5)	6,265 (27.9)	25,975 (115.5)	13,505 (60.1)	13,505 (60.1)	43,285 (192.5)	22,510 (100.1)	22,510 (100.1)	25,510 (113.5)	14,125 (62.8)	11,300 (50.3)
1	26,350 (117.2)	13,700 (60.9)	8,220 (36.6)	34,075 (151.6)	17,720 (78.8)	17,720 (78.8)	56,785 (252.6)	29,530 (131.4)	29,530 (131.4)	33,465 (148.9)	18,535 (82.4)	14,830 (66.0)
1-1/4	42,160 (187.5)	21,920 (97.5)	13,150 (58.5)	54,515 (242.5)	28,345 (126.1)	28,345 (126.1)	90,855 (404.1)	47,245 (210.2)	47,245 (210.2)	41,430 (184.3)	21,545 (95.8)	17,235 (76.7)

1 Tensile = $\phi A_{se,N} f_{uta}$ as noted in ACI 318-14 17.4.1.2

2 Shear = $\phi 0.60 A_{se,V} f_{uta}$ as noted in ACI 318-14 17.5.1.2b.

3 Seismic Shear = $\alpha_{V,seis} \phi V_{sa}$: Reduction factor for seismic shear only. See ACI 318 for additional information on seismic applications.

4 HAS-V, HAS-E (3/8-in to 1-1/4-in), HAS-B, and HAS-R (Class 1; 1-1/4-in) threaded rods are considered ductile steel elements (including HDG rods).

5 HAS-R (CW1 and CW2; 3/8-in to 1-in) threaded rods are considered brittle steel elements.

6 3/8-inch dia. threaded rods are not included in the ASTM F1554 standard. Hilti 3/8-inch dia. HAS-V, HAS-E, and HAS-E-B (incl. HDG) threaded rods meet the chemical composition and mechanical property requirements of ASTM F1554.

3.2.3

Table 30 - Load adjustment factors for 3/8-in. diameter threaded rods in uncracked concrete^{1,2,3}

Embedment h_{ef} in. (mm)	Spacing factor in tension				Edge distance factor in tension				Spacing factor in shear ⁴				Edge distance in shear								Concrete thickness factor in shear ⁵				
	f_{AN}				f_{RN}				f_{AV}				⊥ Toward edge				∥ To and away from edge				f_{HV}				
	2-3/8 (60)	3-3/8 (86)	4-1/2 (114)	7-1/2 (191)	2-3/8 (60)	3-3/8 (86)	4-1/2 (114)	7-1/2 (191)	2-3/8 (60)	3-3/8 (86)	4-1/2 (114)	7-1/2 (191)	2-3/8 (60)	3-3/8 (86)	4-1/2 (114)	7-1/2 (191)	2-3/8 (60)	3-3/8 (86)	4-1/2 (114)	7-1/2 (191)	2-3/8 (60)	3-3/8 (86)	4-1/2 (114)	7-1/2 (191)	
1-3/4 (44)	n/a	n/a	n/a	n/a	0.35	0.26	0.21	0.12	n/a	n/a	n/a	n/a	0.23	0.07	0.05	0.03	0.35	0.14	0.09	0.05	n/a	n/a	n/a	n/a	
1-7/8 (48)	0.58	0.58	0.57	0.54	0.36	0.27	0.22	0.13	0.57	0.53	0.52	0.52	0.25	0.08	0.05	0.03	0.36	0.16	0.10	0.06	n/a	n/a	n/a	n/a	
2 (51)	0.58	0.58	0.57	0.54	0.37	0.28	0.23	0.13	0.57	0.53	0.52	0.52	0.28	0.09	0.06	0.03	0.37	0.17	0.11	0.06	n/a	n/a	n/a	n/a	
3 (76)	0.62	0.62	0.61	0.57	0.48	0.34	0.27	0.16	0.61	0.55	0.54	0.52	0.51	0.16	0.10	0.06	0.48	0.32	0.21	0.11	n/a	n/a	n/a	n/a	
3-5/8 (92)	0.65	0.65	0.63	0.58	0.56	0.38	0.30	0.17	0.63	0.56	0.54	0.53	0.68	0.21	0.14	0.07	0.56	0.38	0.27	0.15	0.72	n/a	n/a	n/a	
4 (102)	0.66	0.66	0.65	0.59	0.62	0.41	0.31	0.18	0.64	0.57	0.55	0.53	0.79	0.24	0.16	0.09	0.62	0.41	0.31	0.17	0.75	n/a	n/a	n/a	
4-5/8 (117)	0.69	0.69	0.67	0.60	0.71	0.45	0.35	0.20	0.66	0.58	0.56	0.54	0.98	0.30	0.20	0.11	0.71	0.45	0.35	0.20	0.81	0.55	n/a	n/a	
5 (127)	0.70	0.70	0.69	0.61	0.77	0.48	0.36	0.21	0.68	0.58	0.56	0.54	1.00	0.34	0.22	0.12	0.77	0.48	0.36	0.21	0.84	0.57	n/a	n/a	
5-3/4 (146)	0.73	0.73	0.71	0.63	0.89	0.55	0.40	0.23	0.70	0.59	0.57	0.55		0.42	0.27	0.15	0.89	0.55	0.40	0.23	0.91	0.61	0.53	n/a	
6 (152)	0.74	0.74	0.72	0.63	0.92	0.58	0.42	0.24	0.71	0.60	0.57	0.55		0.45	0.29	0.16	0.92	0.58	0.42	0.24	0.92	0.63	0.54	n/a	
7 (178)	0.78	0.78	0.76	0.66	1.00	0.67	0.48	0.28	0.75	0.61	0.59	0.56		0.57	0.37	0.20	1.00	0.67	0.48	0.28	1.00	0.68	0.58	n/a	
8 (203)	0.82	0.82	0.80	0.68		0.77	0.55	0.32	0.79	0.63	0.60	0.57		0.69	0.45	0.24		0.77	0.55	0.32		0.72	0.63	n/a	
8-3/4 (222)	0.86	0.86	0.82	0.69		0.84	0.61	0.35	0.81	0.64	0.61	0.57		0.79	0.51	0.28		0.84	0.61	0.35		0.76	0.65	0.53	
9 (229)	0.87	0.87	0.83	0.70		0.86	0.62	0.36	0.82	0.65	0.61	0.57		0.83	0.54	0.29		0.86	0.62	0.36		0.77	0.66	0.54	
10 (254)	0.91	0.91	0.87	0.72		0.96	0.69	0.40	0.86	0.66	0.62	0.58		0.97	0.63	0.34		0.96	0.69	0.40		0.81	0.70	0.57	
11 (279)	0.95	0.95	0.91	0.74		1.00	0.76	0.44	0.89	0.68	0.63	0.59		1.00	0.72	0.39		1.00	0.76	0.44		0.85	0.73	0.60	
12 (305)	0.99	0.99	0.94	0.77			0.83	0.48	0.93	0.70	0.65	0.60			0.83	0.45			0.83	0.48		0.88	0.77	0.63	
14 (356)	1.00	1.00	1.00	0.81			0.97	0.56	1.00	0.73	0.67	0.61			1.00	0.57			0.97	0.56		0.96	0.83	0.68	
16 (406)				0.86			1.00	0.64		0.76	0.70	0.63				0.69			1.00	0.64			1.00	0.88	0.72
18 (457)				0.90				0.72		0.79	0.72	0.65				0.83				0.72			0.94	0.77	
24 (610)				1.00				0.96		0.89	0.79	0.70				1.00				0.96			1.00	0.88	
30 (762)								1.00		0.99	0.87	0.74								1.00				0.99	
36 (914)										1.00	0.94	0.79												1.00	
> 48 (1219)											1.00	0.89													

Table 31 - Load adjustment factors for 3/8-in. diameter threaded rods in cracked concrete^{1,2,3}

Embedment h_{ef} in. (mm)	Spacing factor in tension				Edge distance factor in tension				Spacing factor in shear ⁴				Edge distance in shear								Concrete thickness factor in shear ⁵			
	f_{AN}				f_{RN}				f_{AV}				⊥ Toward edge				∥ To and away from edge				f_{HV}			
	2-3/8 (60)	3-3/8 (86)	4-1/2 (114)	7-1/2 (191)	2-3/8 (60)	3-3/8 (86)	4-1/2 (114)	7-1/2 (191)	2-3/8 (60)	3-3/8 (86)	4-1/2 (114)	7-1/2 (191)	2-3/8 (60)	3-3/8 (86)	4-1/2 (114)	7-1/2 (191)	2-3/8 (60)	3-3/8 (86)	4-1/2 (114)	7-1/2 (191)	2-3/8 (60)	3-3/8 (86)	4-1/2 (114)	7-1/2 (191)
1-3/4 (44)	n/a	n/a	n/a	n/a	0.50	0.50	0.49	0.43	n/a	n/a	n/a	n/a	0.23	0.07	0.06	0.03	0.46	0.15	0.11	0.07	n/a	n/a	n/a	n/a
1-7/8 (48)	0.58	0.58	0.57	0.54	0.52	0.52	0.50	0.44	0.57	0.53	0.53	0.52	0.26	0.08	0.06	0.04	0.51	0.16	0.12	0.07	n/a	n/a	n/a	n/a
2 (51)	0.58	0.58	0.57	0.54	0.53	0.53	0.51	0.44	0.57	0.53	0.53	0.52	0.28	0.09	0.07	0.04	0.53	0.18	0.14	0.08	n/a	n/a	n/a	n/a
3 (76)	0.62	0.62	0.61	0.57	0.63	0.63	0.60	0.49	0.61	0.55	0.54	0.53	0.52	0.17	0.10	0.07	0.63	0.33	0.25	0.15	n/a	n/a	n/a	n/a
3-5/8 (92)	0.65	0.65	0.63	0.58	0.70	0.70	0.66	0.53	0.63	0.56	0.55	0.54	0.69	0.22	0.17	0.10	0.70	0.44	0.33	0.20	0.72	n/a	n/a	n/a
4 (102)	0.66	0.66	0.65	0.59	0.74	0.74	0.70	0.55	0.64	0.57	0.56	0.54	0.80	0.26	0.19	0.11	0.74	0.51	0.38	0.23	0.76	n/a	n/a	n/a
4-5/8 (117)	0.69	0.69	0.67	0.60	0.81	0.81	0.76	0.58	0.67	0.58	0.56	0.55	0.99	0.32	0.24	0.14	0.81	0.63	0.48	0.29	0.81	0.56	n/a	n/a
5 (127)	0.70	0.70	0.69	0.61	0.86	0.86	0.80	0.60	0.68	0.58	0.57	0.55	1.00	0.36	0.27	0.16	0.86	0.71	0.54	0.32	0.85	0.58	n/a	n/a
5-3/4 (146)	0.73	0.73	0.71	0.63	0.93	0.95	0.88	0.64	0.71	0.60	0.58	0.56		0.44	0.33	0.20	0.95	0.88	0.66	0.40	0.91	0.62	0.56	n/a
6 (152)	0.74	0.74	0.72	0.63	0.98	0.98	0.91	0.66	0.71	0.60	0.58	0.56		0.47	0.35	0.21	0.98	0.94	0.70	0.42	0.93	0.63	0.58	n/a
7 (178)	0.78	0.78	0.76	0.66	1.00	1.00	1.00	0.72	0.75	0.62	0.60	0.57		0.59	0.44	0.27	1.00	1.00	0.89	0.53	1.00	0.69	0.62	n/a
8 (203)	0.82	0.82	0.80	0.68				0.78	0.79	0.63	0.61	0.58		0.72	0.54	0.32			1.00	0.65		0.73	0.67	n/a
8-3/4 (222)	0.86	0.86	0.82	0.69				0.83	0.81	0.65	0.62	0.59		0.83	0.62	0.37				0.74		0.77	0.70	0.59
9 (229)	0.87	0.87	0.83	0.70				0.85	0.82	0.65	0.62	0.59		0.86	0.65	0.39				0.78		0.78	0.71	0.60
10 (254)	0.91	0.91	0.87	0.72				0.91	0.86	0.67	0.64	0.60		1.00	0.76	0.45				0.91		0.82	0.74	0.63
11 (279)	0.95	0.95	0.91	0.74				0.98	0.89	0.68	0.65	0.61			0.87	0.52				0.98		0.86	0.78	0.66
12 (305)	0.99	0.99	0.94	0.77				1.00	0.93	0.70	0.67	0.62			1.00	0.60				1.00		0.90	0.82	0.69
14 (356)	1.00	1.00	1.00	0.81				1.00	0.73	0.69	0.64	0.64				0.75						0.97	0.88	0.74
16 (406)				0.86						0.77	0.72	0.66					0.92					1.00	0.94	0.79
18 (457)				0.90						0.80	0.75	0.68					1.00					1.00	0.84	
24 (610)				1.00						0.90	0.83	0.74												0.97
30 (762)										1.00	0.92	0.80												1.00
36 (914)											1.00	0.85												
> 48 (1219)												0.97												

1 Linear interpolation not permitted

2 Shaded area with reduced edge distance is permitted provided the installation torque is reduced to 0.30 T_{max} for 5d ≤ s ≤ 16-in. and to 0.5 T_{max} for s > 16-in.

3 When combining multiple load adjustment factors (e.g. for a four-anchor pattern in a corner with thin concrete member) the design can become very conservative.

To optimize the design, use Hilti PROFIS Anchor Design software or perform anchor calculation using design equations from ACI 318 Chapter 17.

4 Spacing factor reduction in shear applicable when c < 3*h_{ef}. f_{AV} is applicable when edge distance, c < 3*h_{ef}. If c ≥ 3*h_{ef}, then f_{AV} = f_{AN}.

5 Concrete thickness reduction factor in shear, f_{HV} is applicable when edge distance, c < 3*h_{ef}. If c ≥ 3*h_{ef}, then f_{HV} = 1.0.

Table 32 - Load adjustment factors for 1/2-in. diameter threaded rods in uncracked concrete^{1,2,3}

Embedment <i>h_{ef}</i> (mm)	Spacing factor in tension <i>f_{AN}</i>				Edge distance factor in tension <i>f_{RN}</i>				Spacing factor in shear ¹ <i>f_{AV}</i>				Edge distance in shear								Concrete thickness factor in shear ⁵ <i>f_{HV}</i>			
													⊥ Toward edge <i>f_{RV}</i>				∥ To and away from edge <i>f_{RV}</i>							
	2-3/4 (70)	4-1/2 (114)	6 (152)	10 (254)	2-3/4 (70)	4-1/2 (114)	6 (152)	10 (254)	2-3/4 (70)	4-1/2 (114)	6 (152)	10 (254)	2-3/4 (70)	4-1/2 (114)	6 (152)	10 (254)	2-3/4 (70)	4-1/2 (114)	6 (152)	10 (254)	2-3/4 (70)	4-1/2 (114)	6 (152)	10 (254)
1-3/4 (44)	n/a	n/a	n/a	n/a	0.34	0.24	0.19	0.11	n/a	n/a	n/a	n/a	0.10	0.05	0.03	0.02	0.21	0.11	0.07	0.03	n/a	n/a	n/a	n/a
2-1/2 (64)	0.58	0.58	0.57	0.54	0.41	0.28	0.22	0.13	0.55	0.53	0.53	0.52	0.18	0.09	0.06	0.03	0.35	0.18	0.12	0.06	n/a	n/a	n/a	n/a
3 (76)	0.59	0.59	0.58	0.55	0.46	0.30	0.23	0.14	0.56	0.54	0.53	0.52	0.23	0.12	0.08	0.04	0.46	0.24	0.15	0.08	n/a	n/a	n/a	n/a
4 (102)	0.62	0.62	0.61	0.57	0.57	0.35	0.26	0.15	0.58	0.55	0.54	0.53	0.36	0.18	0.12	0.06	0.57	0.35	0.24	0.12	n/a	n/a	n/a	n/a
5 (127)	0.65	0.65	0.64	0.58	0.71	0.40	0.30	0.17	0.60	0.57	0.55	0.53	0.50	0.26	0.17	0.08	0.71	0.40	0.31	0.16	0.65	n/a	n/a	n/a
5-3/4 (146)	0.68	0.68	0.66	0.60	0.78	0.44	0.33	0.19	0.62	0.58	0.56	0.54	0.61	0.32	0.21	0.10	0.81	0.44	0.34	0.20	0.69	0.56	n/a	n/a
6 (152)	0.69	0.69	0.67	0.60	0.80	0.46	0.33	0.20	0.63	0.58	0.56	0.54	0.65	0.34	0.22	0.11	0.85	0.46	0.35	0.21	0.71	0.57	n/a	n/a
7 (178)	0.72	0.72	0.69	0.62	0.90	0.52	0.37	0.22	0.65	0.59	0.57	0.54	0.82	0.42	0.28	0.13	0.99	0.52	0.38	0.27	0.77	0.61	n/a	n/a
7-1/4 (184)	0.72	0.72	0.70	0.62	0.92	0.54	0.38	0.22	0.65	0.60	0.57	0.55	0.87	0.45	0.29	0.14	1.00	0.54	0.39	0.28	0.78	0.62	0.54	n/a
8 (203)	0.75	0.75	0.72	0.63	0.99	0.59	0.41	0.24	0.67	0.61	0.58	0.55	1.00	0.52	0.34	0.16		0.59	0.42	0.30	0.82	0.66	0.57	n/a
9 (229)	0.78	0.78	0.75	0.65	1.00	0.67	0.46	0.27	0.69	0.62	0.59	0.56		0.62	0.40	0.20		0.67	0.46	0.32	0.87	0.70	0.60	n/a
10 (254)	0.81	0.81	0.78	0.67		0.74	0.52	0.30	0.71	0.63	0.60	0.56		0.72	0.47	0.23		0.74	0.52	0.34	0.92	0.73	0.64	n/a
11-1/4 (286)	0.85	0.85	0.81	0.69		0.83	0.58	0.34	0.74	0.65	0.61	0.57		0.86	0.56	0.27		0.83	0.58	0.37	0.97	0.78	0.67	0.53
12 (305)	0.87	0.87	0.83	0.70		0.89	0.62	0.36	0.75	0.66	0.62	0.58		0.95	0.62	0.30		0.89	0.62	0.38	1.00	0.80	0.70	0.55
14 (356)	0.93	0.93	0.89	0.73		1.00	0.72	0.42	0.79	0.69	0.64	0.59		1.00	0.78	0.38		1.00	0.72	0.43		0.87	0.75	0.59
16 (406)	1.00	1.00	0.94	0.77			0.82	0.48	0.83	0.72	0.66	0.60			0.95	0.47			0.82	0.48		0.93	0.80	0.63
18 (457)			1.00	0.80			0.93	0.54	0.88	0.74	0.68	0.61			1.00	0.56			0.93	0.54		0.98	0.85	0.67
20 (508)				0.83			1.00	0.60	0.92	0.77	0.70	0.63				0.65			1.00	0.60		1.00	0.90	0.71
22 (559)				0.87				0.66	0.96	0.80	0.72	0.64				0.75				0.66			0.94	0.74
24 (610)				0.90				0.72	1.00	0.82	0.74	0.65				0.85				0.72			0.98	0.77
30 (762)				1.00				0.90		0.90	0.80	0.69				1.00				0.90			1.00	0.87
36 (914)								1.00		0.98	0.86	0.73								1.00				0.95
> 48 (1219)										1.00	0.98	0.80												1.00

3.2.3

Table 33 - Load adjustment factors for 1/2-in. diameter threaded rods in cracked concrete^{1,2,3}

Embedment <i>h_{ef}</i> (mm)	Spacing factor in tension <i>f_{AN}</i>				Edge distance factor in tension <i>f_{RN}</i>				Spacing factor in shear ¹ <i>f_{AV}</i>				Edge distance in shear								Concrete thickness factor in shear ⁵ <i>f_{HV}</i>			
													⊥ Toward edge <i>f_{RV}</i>				∥ To and away from edge <i>f_{RV}</i>							
	2-3/4 (70)	4-1/2 (114)	6 (152)	10 (254)	2-3/4 (70)	4-1/2 (114)	6 (152)	10 (254)	2-3/4 (70)	4-1/2 (114)	6 (152)	10 (254)	2-3/4 (70)	4-1/2 (114)	6 (152)	10 (254)	2-3/4 (70)	4-1/2 (114)	6 (152)	10 (254)	2-3/4 (70)	4-1/2 (114)	6 (152)	10 (254)
1-3/4 (44)	n/a	n/a	n/a	n/a	0.47	0.47	0.45	0.41	n/a	n/a	n/a	n/a	0.10	0.05	0.04	0.02	0.21	0.11	0.07	0.04	n/a	n/a	n/a	n/a
2-1/2 (64)	0.58	0.58	0.57	0.54	0.52	0.52	0.50	0.44	0.55	0.53	0.53	0.52	0.18	0.09	0.06	0.04	0.35	0.18	0.12	0.07	n/a	n/a	n/a	n/a
3 (76)	0.59	0.59	0.58	0.55	0.56	0.56	0.53	0.46	0.56	0.54	0.53	0.52	0.23	0.12	0.08	0.05	0.47	0.24	0.16	0.10	n/a	n/a	n/a	n/a
4 (102)	0.62	0.62	0.61	0.57	0.63	0.63	0.60	0.49	0.58	0.55	0.54	0.53	0.36	0.18	0.13	0.08	0.72	0.37	0.25	0.15	0.58	n/a	n/a	n/a
5 (127)	0.65	0.65	0.64	0.58	0.72	0.72	0.67	0.53	0.61	0.57	0.55	0.54	0.50	0.26	0.18	0.11	1.00	0.52	0.35	0.21	0.65	n/a	n/a	n/a
5-3/4 (146)	0.68	0.68	0.66	0.60	0.78	0.78	0.73	0.56	0.62	0.58	0.56	0.54	0.62	0.32	0.22	0.13		0.64	0.43	0.26	0.70	0.56	n/a	n/a
6 (152)	0.69	0.69	0.67	0.60	0.80	0.80	0.75	0.57	0.63	0.58	0.56	0.54	0.66	0.34	0.23	0.14		0.68	0.46	0.28	0.71	0.57	n/a	n/a
7 (178)	0.72	0.72	0.69	0.62	0.90	0.90	0.83	0.62	0.65	0.59	0.57	0.55	0.83	0.43	0.29	0.17		0.86	0.58	0.35	0.77	0.62	n/a	n/a
7-1/4 (184)	0.72	0.72	0.70	0.62	0.92	0.92	0.85	0.63	0.65	0.60	0.58	0.55	0.88	0.45	0.31	0.18		0.90	0.61	0.37	0.78	0.63	0.55	n/a
8 (203)	0.75	0.75	0.72	0.63	0.99	0.99	0.91	0.66	0.67	0.61	0.58	0.56	1.00	0.52	0.35	0.21		1.00	0.71	0.43	0.82	0.66	0.58	n/a
9 (229)	0.78	0.78	0.75	0.65	1.00	1.00	1.00	0.70	0.69	0.62	0.59	0.57		0.62	0.42	0.25			0.85	0.51	0.87	0.70	0.61	n/a
10 (254)	0.81	0.81	0.78	0.67				0.75	0.71	0.64	0.60	0.57		0.73	0.50	0.30			0.99	0.59	0.92	0.74	0.65	n/a
11-1/4 (286)	0.85	0.85	0.81	0.69				0.81	0.74	0.65	0.62	0.58		0.87	0.59	0.35			1.00	0.71	0.97	0.78	0.69	0.58
12 (305)	0.87	0.87	0.83	0.70				0.85	0.75	0.66	0.63	0.59		0.96	0.65	0.39				0.78	1.00	0.81	0.71	0.60
14 (356)	0.93	0.93	0.89	0.73				0.95	0.79	0.69	0.65	0.60		1.00	0.82	0.49				0.95		0.87	0.76	0.64
16 (406)	1.00	1.00	0.94	0.77				1.00	0.84	0.72	0.67	0.62			1.00	0.60				1.00		0.93	0.82	0.69
18 (457)			1.00	0.80					0.88	0.74	0.69	0.63				0.72						0.99	0.87	0.73
20 (508)				0.83					0.92	0.77	0.71	0.65				0.84						1.00	0.91	0.77
22 (559)				0.87					0.96	0.80	0.73	0.66				0.97							0.96	0.81
24 (610)				0.90					1.00	0.82	0.75	0.68				1.00							1.00	0.84
30 (762)				1.00						0.91	0.81	0.72												0.94
36 (914)										0.99	0.88	0.77												1.00
> 48 (1219)										1.00	1.00	0.86												

- Linear interpolation not permitted.
- Shaded area with reduced edge distance is permitted provided the installation torque is reduced to 0.30 T_{max} for 5d ≤ s ≤ 16-in. and to 0.5 T_{max} for s > 16-in.
- When combining multiple load adjustment factors (e.g. for a 4 anchor pattern in a corner with a thin concrete member) the design can become very conservative. To optimize the design, use Hilti PROFIS Anchor Design software or perform anchor calculation using the design equations from ACI 318 Chapter 17.
- Spacing factor reduction in shear applicable when c < 3*h_{ef}. *f_{AV}* is applicable when edge distance, c < 3*h_{ef}. If c ≥ 3*h_{ef} then *f_{AV}* = *f_{AN}*.
- Concrete thickness reduction factor in shear, *f_{HV}* is applicable when edge distance, c < 3*h_{ef}. If c ≥ 3*h_{ef} then *f_{HV}* = 1.0.

Table 34 - Load adjustment factors for 5/8-in. diameter threaded rods in uncracked concrete^{1,2,3}

5/8-in. uncracked concrete	Spacing factor in tension f_{AN}				Edge distance factor in tension f_{RN}				Spacing factor in shear ⁴ f_{AV}				Edge distance in shear								Concrete thickness factor in shear ⁵ f_{HV}			
													⊥ Toward edge f_{RV}				∥ To and away from edge f_{RV}							
	Embedment h_{ef} (mm)	3-1/8 (79)	5-5/8 (143)	7-1/2 (191)	12-1/2 (318)	3-1/8 (79)	5-5/8 (143)	7-1/2 (191)	12-1/2 (318)	3-1/8 (79)	5-5/8 (143)	7-1/2 (191)	12-1/2 (318)	3-1/8 (79)	5-5/8 (143)	7-1/2 (191)	12-1/2 (318)	3-1/8 (79)	5-5/8 (143)	7-1/2 (191)	12-1/2 (318)	3-1/8 (79)	5-5/8 (143)	7-1/2 (191)
1-3/4 (44)	n/a	n/a	n/a	n/a	0.35	0.24	0.19	0.11	n/a	n/a	n/a	n/a	0.09	0.04	0.03	0.01	0.19	0.08	0.06	0.03	n/a	n/a	n/a	n/a
3-1/8 (79)	0.58	0.58	0.57	0.54	0.47	0.29	0.22	0.13	0.56	0.54	0.53	0.52	0.22	0.10	0.07	0.03	0.45	0.20	0.13	0.06	n/a	n/a	n/a	n/a
4 (102)	0.60	0.60	0.59	0.55	0.56	0.32	0.24	0.14	0.58	0.55	0.53	0.52	0.32	0.15	0.10	0.04	0.56	0.29	0.19	0.09	n/a	n/a	n/a	n/a
4-5/8 (117)	0.62	0.62	0.60	0.56	0.62	0.35	0.26	0.15	0.59	0.55	0.54	0.52	0.40	0.18	0.12	0.06	0.62	0.35	0.24	0.11	0.60	n/a	n/a	n/a
5 (127)	0.63	0.63	0.61	0.57	0.64	0.36	0.27	0.16	0.60	0.56	0.54	0.53	0.45	0.21	0.13	0.06	0.67	0.36	0.27	0.12	0.63	n/a	n/a	n/a
6 (152)	0.65	0.65	0.63	0.58	0.71	0.41	0.30	0.17	0.62	0.57	0.55	0.53	0.59	0.27	0.18	0.08	0.80	0.41	0.32	0.16	0.69	n/a	n/a	n/a
7 (178)	0.68	0.68	0.66	0.59	0.78	0.45	0.33	0.19	0.64	0.58	0.56	0.54	0.75	0.34	0.22	0.10	0.94	0.45	0.35	0.21	0.74	n/a	n/a	n/a
7-1/8 (181)	0.68	0.68	0.66	0.60	0.79	0.46	0.33	0.19	0.64	0.58	0.56	0.54	0.77	0.35	0.23	0.11	0.95	0.46	0.35	0.21	0.75	0.57	n/a	n/a
8 (203)	0.70	0.70	0.68	0.61	0.85	0.50	0.36	0.21	0.66	0.59	0.57	0.54	0.91	0.41	0.27	0.13	1.00	0.50	0.38	0.25	0.79	0.61	n/a	n/a
9 (229)	0.73	0.73	0.70	0.62	0.93	0.56	0.39	0.22	0.68	0.60	0.58	0.55	1.00	0.50	0.32	0.15		0.56	0.41	0.29	0.84	0.65	0.56	n/a
10 (254)	0.75	0.75	0.72	0.63	1.00	0.62	0.43	0.24	0.70	0.62	0.59	0.55		0.58	0.38	0.18		0.62	0.44	0.30	0.89	0.68	0.59	n/a
11 (279)	0.78	0.78	0.74	0.65		0.68	0.47	0.27	0.72	0.63	0.60	0.56		0.67	0.43	0.20		0.68	0.47	0.32	0.93	0.71	0.62	n/a
12 (305)	0.80	0.80	0.77	0.66		0.74	0.51	0.29	0.74	0.64	0.60	0.56		0.76	0.50	0.23		0.74	0.51	0.34	0.97	0.75	0.65	n/a
14 (356)	0.85	0.85	0.81	0.69		0.86	0.60	0.34	0.77	0.66	0.62	0.57		0.96	0.62	0.29		0.86	0.60	0.37	1.00	0.81	0.70	0.54
16 (406)	0.90	0.90	0.86	0.71		0.99	0.68	0.39	0.81	0.69	0.64	0.58		1.00	0.76	0.35		0.99	0.68	0.41		0.86	0.75	0.58
18 (457)	0.96	0.96	0.90	0.74		1.00	0.77	0.44	0.85	0.71	0.66	0.59			0.91	0.42		1.00	0.77	0.44		0.91	0.79	0.61
20 (508)	1.00	1.00	0.94	0.77			0.86	0.49	0.89	0.73	0.67	0.60			1.00	0.50			0.86	0.49		0.96	0.83	0.65
22 (559)			0.99	0.79			0.94	0.54	0.93	0.75	0.69	0.61				0.57			0.94	0.54		1.00	0.87	0.68
24 (610)			1.00	0.82			1.00	0.59	0.97	0.78	0.71	0.63				0.65			1.00	0.59			0.91	0.71
26 (660)				0.85				0.64	1.00	0.80	0.73	0.64				0.73				0.64			0.95	0.74
28 (711)				0.87				0.68		0.82	0.74	0.65				0.82				0.68			0.99	0.76
30 (762)				0.90				0.73		0.85	0.76	0.66				0.91				0.73			1.00	0.79
36 (914)				0.98				0.88		0.92	0.81	0.69				1.00				0.88				0.87
> 48 (1219)				1.00				1.00		1.00	0.92	0.75								1.00				1.00

Table 35 - Load adjustment factors for 5/8-in. diameter threaded rods in cracked concrete^{1,2,3}

5/8-in. cracked concrete	Spacing factor in tension f_{AN}				Edge distance factor in tension f_{RN}				Spacing factor in shear ⁴ f_{AV}				Edge distance in shear								Concrete thickness factor in shear ⁵ f_{HV}			
													⊥ Toward edge f_{RV}				∥ To and away from edge f_{RV}							
	Embedment h_{ef} (mm)	3-1/8 (79)	5-5/8 (143)	7-1/2 (191)	12-1/2 (318)	3-1/8 (79)	5-5/8 (143)	7-1/2 (191)	12-1/2 (318)	3-1/8 (79)	5-5/8 (143)	7-1/2 (191)	12-1/2 (318)	3-1/8 (79)	5-5/8 (143)	7-1/2 (191)	12-1/2 (318)	3-1/8 (79)	5-5/8 (143)	7-1/2 (191)	12-1/2 (318)	3-1/8 (79)	5-5/8 (143)	7-1/2 (191)
1-3/4 (44)	n/a	n/a	n/a	n/a	0.44	0.44	0.43	0.40	n/a	n/a	n/a	n/a	0.09	0.04	0.03	0.02	0.19	0.09	0.06	0.03	n/a	n/a	n/a	n/a
3-1/8 (79)	0.58	0.58	0.57	0.54	0.52	0.52	0.50	0.44	0.56	0.54	0.53	0.52	0.22	0.10	0.07	0.04	0.45	0.20	0.13	0.07	n/a	n/a	n/a	n/a
4 (102)	0.60	0.60	0.59	0.55	0.58	0.58	0.55	0.46	0.58	0.55	0.53	0.52	0.33	0.15	0.10	0.05	0.65	0.30	0.19	0.11	n/a	n/a	n/a	n/a
4-5/8 (117)	0.62	0.62	0.60	0.56	0.62	0.62	0.58	0.48	0.59	0.55	0.54	0.53	0.40	0.18	0.12	0.07	0.81	0.37	0.24	0.13	0.60	n/a	n/a	n/a
5 (127)	0.63	0.63	0.61	0.57	0.64	0.64	0.60	0.49	0.60	0.56	0.54	0.53	0.45	0.21	0.13	0.08	0.91	0.41	0.27	0.15	0.63	n/a	n/a	n/a
6 (152)	0.65	0.65	0.63	0.58	0.71	0.71	0.66	0.53	0.62	0.57	0.55	0.54	0.60	0.27	0.18	0.10	1.00	0.54	0.35	0.20	0.69	n/a	n/a	n/a
7 (178)	0.68	0.68	0.66	0.59	0.78	0.78	0.72	0.56	0.64	0.58	0.56	0.54	0.75	0.34	0.22	0.13		0.68	0.44	0.25	0.74	n/a	n/a	n/a
7-1/8 (181)	0.68	0.68	0.66	0.60	0.79	0.79	0.73	0.56	0.64	0.58	0.56	0.54	0.77	0.35	0.23	0.13		0.70	0.46	0.26	0.75	0.58	n/a	n/a
8 (203)	0.70	0.70	0.68	0.61	0.85	0.85	0.78	0.59	0.66	0.59	0.57	0.55	0.92	0.42	0.27	0.15		0.84	0.54	0.31	0.79	0.61	n/a	n/a
9 (229)	0.73	0.73	0.70	0.62	0.93	0.93	0.85	0.62	0.68	0.60	0.58	0.55	1.00	0.50	0.32	0.18		1.00	0.65	0.37	0.84	0.65	0.56	n/a
10 (254)	0.75	0.75	0.72	0.63	1.00	1.00	0.91	0.66	0.70	0.62	0.59	0.56		0.58	0.38	0.21			0.76	0.43	0.89	0.68	0.59	n/a
11 (279)	0.78	0.78	0.74	0.65			0.98	0.69	0.72	0.63	0.60	0.57		0.67	0.44	0.25			0.88	0.49	0.93	0.72	0.62	n/a
12 (305)	0.80	0.80	0.77	0.66			1.00	0.73	0.74	0.64	0.60	0.57		0.77	0.50	0.28			1.00	0.56	0.97	0.75	0.65	n/a
14 (356)	0.85	0.85	0.81	0.69				0.81	0.78	0.66	0.62	0.58		0.97	0.63	0.36				0.71	1.00	0.81	0.70	0.58
16 (406)	0.90	0.90	0.86	0.71				0.89	0.82	0.69	0.64	0.60		1.00	0.77	0.43				0.87		0.86	0.75	0.62
18 (457)	0.96	0.96	0.90	0.74				0.97	0.85	0.71	0.66	0.61			0.92	0.52				0.97		0.92	0.79	0.66
20 (508)	1.00	1.00	0.94	0.77				1.00	0.89	0.73	0.67	0.62			1.00	0.61				1.00		0.97	0.84	0.69
22 (559)			0.99	0.79					0.93	0.76	0.69	0.63				0.70						1.00	0.88	0.72
24 (610)			1.00	0.82					0.97	0.78	0.71	0.64				0.80							0.92	0.76
26 (660)				0.85					1.00	0.80	0.73	0.66				0.90							0.95	0.79
28 (711)				0.87						0.83	0.74	0.67				1.00							0.99	0.82
30 (762)				0.90						0.85	0.76	0.68											1.00	0.85
36 (914)				0.98						0.92	0.81	0.71												0.93
> 48 (1219)				1.00						1.00	0.92	0.79												1.00

1 Linear interpolation not permitted
 2 Shaded area with reduced edge distance is permitted provided the installation torque is reduced to 0.30 T_{max} for 5d ≤ s ≤ 16-in. and to 0.5 T_{max} for s > 16-in.
 3 When combining multiple load adjustment factors (e.g. for a four-anchor pattern in a corner with thin concrete member) the design can become very conservative. To optimize the design, use Hilti PROFIS Anchor Design software or perform anchor calculation using design equations from ACI 318 Chapter 17.
 4 Spacing factor reduction in shear applicable when c < 3*h_{ef}. f_{AV} is applicable when edge distance, c < 3*h_{ef}. If c ≥ 3*h_{ef}, then f_{AV} = f_{AN}.
 5 Concrete thickness reduction factor in shear, f_{HV}, is applicable when edge distance, c < 3*h_{ef}. If c ≥ 3*h_{ef}, then f_{HV} = 1.0.

Table 36 - Load adjustment factors for 3/4-in. diameter threaded rods in uncracked concrete^{1,2,3}

3/4-in. uncracked concrete	Spacing factor in tension f_{AN}				Edge distance factor in tension f_{RN}				Spacing factor in shear ⁴ f_{AV}				Edge distance in shear								Concrete thickness factor in shear ⁵ f_{HV}				
													⊥ Toward edge f_{RV}				To and away from edge f_{RV}								
	Embedment in. h_{ef} (mm)	3-1/2 (89)	6-3/4 (171)	9 (229)	15 (381)	3-1/2 (89)	6-3/4 (171)	9 (229)	15 (381)	3-1/2 (89)	6-3/4 (171)	9 (229)	15 (381)	3-1/2 (89)	6-3/4 (171)	9 (229)	15 (381)	3-1/2 (89)	6-3/4 (171)	9 (229)	15 (381)	3-1/2 (89)	6-3/4 (171)	9 (229)	15 (381)
1-3/4 (44)	n/a	n/a	n/a	n/a	0.35	0.24	0.18	0.10	n/a	n/a	n/a	n/a	0.09	0.03	0.02	0.01	0.17	0.07	0.05	0.02	n/a	n/a	n/a	n/a	
3-3/4 (95)	0.58	0.58	0.57	0.54	0.52	0.30	0.23	0.13	0.57	0.54	0.53	0.52	0.27	0.11	0.07	0.03	0.52	0.22	0.14	0.07	n/a	n/a	n/a	n/a	
4 (102)	0.59	0.59	0.57	0.54	0.54	0.31	0.23	0.13	0.57	0.54	0.53	0.52	0.29	0.12	0.08	0.04	0.54	0.24	0.16	0.07	n/a	n/a	n/a	n/a	
5 (127)	0.61	0.61	0.59	0.56	0.59	0.34	0.25	0.14	0.59	0.55	0.54	0.52	0.41	0.17	0.11	0.05	0.64	0.33	0.22	0.10	n/a	n/a	n/a	n/a	
5-1/4 (133)	0.61	0.61	0.60	0.56	0.61	0.35	0.26	0.15	0.60	0.55	0.54	0.52	0.44	0.18	0.12	0.05	0.66	0.35	0.23	0.11	0.62	n/a	n/a	n/a	
6 (152)	0.63	0.63	0.61	0.57	0.65	0.38	0.28	0.16	0.61	0.56	0.55	0.53	0.54	0.22	0.14	0.07	0.76	0.38	0.29	0.13	0.66	n/a	n/a	n/a	
7 (178)	0.65	0.65	0.63	0.58	0.70	0.41	0.30	0.17	0.63	0.57	0.55	0.53	0.68	0.28	0.18	0.08	0.89	0.41	0.32	0.17	0.72	n/a	n/a	n/a	
8 (203)	0.67	0.67	0.65	0.59	0.76	0.45	0.33	0.18	0.65	0.58	0.56	0.54	0.83	0.34	0.22	0.10	1.00	0.45	0.35	0.20	0.77	n/a	n/a	n/a	
8-1/2 (216)	0.68	0.68	0.66	0.59	0.79	0.47	0.34	0.19	0.66	0.59	0.56	0.54	0.91	0.37	0.24	0.11		0.47	0.36	0.22	0.79	0.59	n/a	n/a	
9 (229)	0.69	0.69	0.67	0.60	0.83	0.49	0.35	0.20	0.67	0.59	0.57	0.54	0.99	0.40	0.26	0.12		0.49	0.37	0.24	0.81	0.60	n/a	n/a	
10 (254)	0.71	0.71	0.69	0.61	0.89	0.53	0.38	0.21	0.68	0.60	0.58	0.55	1.00	0.47	0.31	0.14		0.53	0.40	0.28	0.86	0.64	n/a	n/a	
10-3/4 (273)	0.73	0.73	0.70	0.62	0.94	0.57	0.40	0.23	0.70	0.61	0.58	0.55		0.53	0.34	0.16		0.57	0.42	0.29	0.89	0.66	0.57	n/a	
12 (305)	0.76	0.76	0.72	0.63	1.00	0.64	0.44	0.25	0.72	0.62	0.59	0.55		0.62	0.40	0.19		0.64	0.45	0.31	0.94	0.70	0.60	n/a	
14 (356)	0.80	0.80	0.76	0.66		0.74	0.52	0.29	0.76	0.64	0.61	0.56		0.78	0.51	0.24		0.74	0.52	0.33	1.00	0.75	0.65	n/a	
16 (406)	0.84	0.84	0.80	0.68		0.85	0.59	0.33	0.79	0.66	0.62	0.57		0.96	0.62	0.29		0.85	0.59	0.36		0.80	0.70	n/a	
16-3/4 (425)	0.86	0.86	0.81	0.69		0.89	0.62	0.35	0.81	0.67	0.63	0.58		1.00	0.67	0.31		0.89	0.62	0.37		0.82	0.71	0.55	
18 (457)	0.89	0.89	0.83	0.70		0.96	0.66	0.37	0.83	0.68	0.64	0.58			0.74	0.35		0.96	0.66	0.39		0.85	0.74	0.57	
20 (508)	0.93	0.93	0.87	0.72		1.00	0.74	0.41	0.87	0.70	0.65	0.59			0.87	0.40		1.00	0.74	0.42		0.90	0.78	0.60	
22 (559)	0.97	0.97	0.91	0.74			0.81	0.45	0.91	0.72	0.67	0.60			1.00	0.47			0.81	0.46			0.94	0.82	0.63
24 (610)	1.00	1.00	0.94	0.77			0.89	0.50	0.94	0.74	0.68	0.61				0.53			0.89	0.50			0.99	0.85	0.66
26 (660)			0.98	0.79			0.96	0.54	0.98	0.76	0.70	0.62				0.60			0.96	0.54			1.00	0.89	0.69
28 (711)			1.00	0.81			1.00	0.58	1.00	0.78	0.71	0.63				0.67			1.00	0.58				0.92	0.71
30 (762)				0.83			0.62	0.47	0.62	0.80	0.73	0.64				0.74				0.62				0.95	0.74
36 (914)				0.90			0.74	0.47	0.74	0.86	0.77	0.66				0.98				0.74				1.00	0.81
> 48 (1219)				1.00			0.99	0.47	0.99	0.99	0.86	0.72				1.00				0.99					0.94

3.2.3

Table 37 - Load adjustment factors for 3/4-in. diameter threaded rods in cracked concrete^{1,2,3}

3/4-in. cracked concrete	Spacing factor in tension f_{AN}				Edge distance factor in tension f_{RN}				Spacing factor in shear ⁴ f_{AV}				Edge distance in shear								Concrete thickness factor in shear ⁵ f_{HV}			
													⊥ Toward edge f_{RV}				To and away from edge f_{RV}							
	Embedment in. h_{ef} (mm)	3-1/2 (89)	6-3/4 (171)	9 (229)	15 (381)	3-1/2 (89)	6-3/4 (171)	9 (229)	15 (381)	3-1/2 (89)	6-3/4 (171)	9 (229)	15 (381)	3-1/2 (89)	6-3/4 (171)	9 (229)	15 (381)	3-1/2 (89)	6-3/4 (171)	9 (229)	15 (381)	3-1/2 (89)	6-3/4 (171)	9 (229)
1-3/4 (44)	n/a	n/a	n/a	n/a	0.43	0.43	0.42	0.39	n/a	n/a	n/a	n/a	0.09	0.03	0.02	0.01	0.17	0.07	0.05	0.02	n/a	n/a	n/a	n/a
3-3/4 (95)	0.58	0.58	0.57	0.54	0.53	0.53	0.50	0.44	0.57	0.54	0.53	0.52	0.27	0.11	0.07	0.04	0.54	0.22	0.14	0.07	n/a	n/a	n/a	n/a
4 (102)	0.59	0.59	0.57	0.54	0.54	0.54	0.51	0.44	0.57	0.54	0.53	0.52	0.30	0.12	0.08	0.04	0.59	0.24	0.16	0.08	n/a	n/a	n/a	n/a
5 (127)	0.61	0.61	0.59	0.56	0.59	0.59	0.56	0.47	0.59	0.55	0.54	0.52	0.41	0.17	0.11	0.06	0.83	0.34	0.22	0.11	n/a	n/a	n/a	n/a
5-1/4 (133)	0.61	0.61	0.60	0.56	0.61	0.61	0.57	0.47	0.60	0.55	0.54	0.53	0.45	0.18	0.12	0.06	0.89	0.36	0.24	0.12	0.62	n/a	n/a	n/a
6 (152)	0.63	0.63	0.61	0.57	0.65	0.65	0.60	0.49	0.61	0.56	0.55	0.53	0.54	0.22	0.14	0.07	1.00	0.44	0.29	0.15	0.67	n/a	n/a	n/a
7 (178)	0.65	0.65	0.63	0.58	0.70	0.70	0.65	0.52	0.63	0.57	0.55	0.53	0.69	0.28	0.18	0.09		0.56	0.36	0.19	0.72	n/a	n/a	n/a
8 (203)	0.67	0.67	0.65	0.59	0.76	0.76	0.70	0.55	0.65	0.58	0.56	0.54	0.84	0.34	0.22	0.12		0.68	0.44	0.23	0.77	n/a	n/a	n/a
8-1/2 (216)	0.68	0.68	0.66	0.59	0.79	0.79	0.72	0.56	0.66	0.59	0.56	0.54	0.92	0.37	0.24	0.13		0.75	0.49	0.25	0.79	0.59	n/a	n/a
9 (229)	0.69	0.69	0.67	0.60	0.83	0.83	0.75	0.57	0.67	0.59	0.57	0.54	1.00	0.41	0.26	0.14		0.82	0.53	0.28	0.82	0.61	n/a	n/a
10 (254)	0.71	0.71	0.69	0.61	0.89	0.89	0.80	0.60	0.69	0.60	0.58	0.55		0.48	0.31	0.16		0.95	0.62	0.32	0.86	0.64	n/a	n/a
10-3/4 (273)	0.73	0.73	0.70	0.62	0.94	0.94	0.84	0.62	0.70	0.61	0.58	0.55		0.53	0.35	0.18		1.00	0.69	0.36	0.89	0.66	0.57	n/a
12 (305)	0.76	0.76	0.72	0.63	1.00	1.00	0.91	0.66	0.72	0.62	0.59	0.56		0.63	0.41	0.21			0.82	0.42	0.84	0.70	0.61	n/a
14 (356)	0.80	0.80	0.76	0.66			1.00	0.72	0.76	0.64	0.61	0.57		0.79	0.51	0.27			1.00	0.53	1.00	0.76	0.65	n/a
16 (406)	0.84	0.84	0.80	0.68				0.78	0.80	0.66	0.62	0.58		0.97	0.63	0.33				0.65		0.81	0.70	n/a
16-3/4 (425)	0.86	0.86	0.81	0.69				0.81	0.81	0.67	0.63	0.58		1.00	0.67	0.35				0.70		0.83	0.72	0.57
18 (457)	0.89	0.89	0.83	0.70				0.85	0.83	0.68	0.64	0.59			0.75	0.39				0.78		0.86	0.74	0.60
20 (508)	0.93	0.93	0.87	0.72				0.91	0.87	0.70	0.65	0.60			0.88	0.46				0.91		0.90	0.78	0.63
22 (559)	0.97	0.97	0.91	0.74				0.98	0.91	0.72	0.67	0.61			1.00	0.53				0.98		0.95	0.82	0.66
24 (610)	1.00	1.00	0.94	0.77				1.00	0.94	0.74	0.68	0.62				0.60				1.00		0.99	0.86	0.69
26 (660)			0.98	0.79					0.98	0.76	0.70	0.63				0.68						1.00	0.89	0.72
28 (711)			1.00	0.81					1.00	0.79	0.71	0.64				0.75							0.92	0.74
30 (762)				0.83						0.81	0.73	0.65				0.84							0.96	0.77
36 (914)				0.90						0.87	0.77	0.68				1.00							1.00	0.84
> 48 (1219)				1.00						0.99	0.87	0.74												0.97

- Linear interpolation not permitted.
- Shaded area with reduced edge distance is permitted provided the installation torque is reduced to 0.30 T_{max} for 5d ≤ s ≤ 16-in. and to 0.5 T_{max} for s > 16-in.
- When combining multiple load adjustment factors (e.g. for a 4 anchor pattern in a corner with a thin concrete member) the design can become very conservative. To optimize the design, use Hilti PROFIS Anchor Design software or perform anchor calculation using the design equations from ACI 318 Chapter 17.
- Spacing factor reduction in shear applicable when c < 3*h_{ef}. f_{AV} is applicable when edge distance, c < 3*h_{ef}. If c ≥ 3*h_{ef}, then f_{AV} = f_{AN}.
- Concrete thickness reduction factor in shear, f_{HV} is applicable when edge distance, c < 3*h_{ef}. If c ≥ 3*h_{ef}, then f_{HV} = 1.0.

Table 38 - Load adjustment factors for 7/8-in. diameter threaded rods in uncracked concrete^{1,2,3}

Embedment h_{ef}	in. (mm)	Spacing factor in tension f_{AN}				Edge distance factor in tension f_{RN}				Spacing factor in shear ⁴ f_{AV}				Edge distance in shear								Concrete thickness factor in shear ⁵ f_{HV}			
														⊥ Toward edge f_{RV}				∥ To and away from edge f_{RV}							
		3-1/2	7-7/8	10-1/2	17-1/2	3-1/2	7-7/8	10-1/2	17-1/2	3-1/2	7-7/8	10-1/2	17-1/2	3-1/2	7-7/8	10-1/2	17-1/2	3-1/2	7-7/8	10-1/2	17-1/2	3-1/2	7-7/8	10-1/2	17-1/2
(89)	(200)	(267)	(445)	(89)	(200)	(267)	(445)	(89)	(200)	(267)	(445)	(89)	(200)	(267)	(445)	(89)	(200)	(267)	(445)	(89)	(200)	(267)	(445)		
1-3/4 (44)	n/a	n/a	n/a	n/a	0.39	0.24	0.18	0.10	n/a	n/a	n/a	n/a	0.09	0.03	0.02	0.01	0.18	0.05	0.04	0.02	n/a	n/a	n/a	n/a	
4-3/8 (111)	0.58	0.58	0.57	0.54	0.53	0.31	0.23	0.13	0.58	0.54	0.53	0.52	0.35	0.11	0.07	0.03	0.63	0.22	0.14	0.07	n/a	n/a	n/a	n/a	
5 (127)	0.59	0.59	0.58	0.55	0.56	0.33	0.24	0.13	0.59	0.54	0.53	0.52	0.43	0.13	0.09	0.04	0.70	0.27	0.17	0.09	n/a	n/a	n/a	n/a	
5-1/2 (140)	0.60	0.60	0.59	0.55	0.58	0.34	0.25	0.14	0.60	0.55	0.54	0.52	0.50	0.15	0.10	0.05	0.76	0.31	0.20	0.09	0.65	n/a	n/a	n/a	
6 (152)	0.61	0.61	0.60	0.56	0.61	0.36	0.26	0.15	0.61	0.55	0.54	0.52	0.57	0.17	0.11	0.05	0.83	0.35	0.23	0.11	0.68	n/a	n/a	n/a	
7 (178)	0.63	0.63	0.61	0.57	0.65	0.39	0.28	0.16	0.63	0.56	0.55	0.53	0.71	0.22	0.14	0.07	0.97	0.39	0.29	0.13	0.73	n/a	n/a	n/a	
8 (203)	0.65	0.65	0.63	0.58	0.71	0.42	0.31	0.17	0.65	0.57	0.55	0.53	0.87	0.27	0.17	0.08	1.00	0.42	0.33	0.16	0.78	n/a	n/a	n/a	
9 (229)	0.67	0.67	0.64	0.59	0.76	0.45	0.33	0.18	0.67	0.58	0.56	0.54	1.00	0.32	0.21	0.10		0.45	0.35	0.19	0.83	n/a	n/a	n/a	
9-7/8 (251)	0.69	0.69	0.66	0.59	0.80	0.48	0.35	0.19	0.69	0.59	0.56	0.54		0.37	0.24	0.11		0.48	0.37	0.22	0.87	0.59	n/a	n/a	
10 (254)	0.69	0.69	0.66	0.60	0.81	0.49	0.35	0.19	0.69	0.59	0.57	0.54		0.38	0.24	0.11		0.49	0.37	0.23	0.87	0.59	n/a	n/a	
11 (279)	0.71	0.71	0.67	0.60	0.87	0.52	0.38	0.21	0.71	0.60	0.57	0.54		0.43	0.28	0.13		0.52	0.40	0.26	0.91	0.62	n/a	n/a	
12 (305)	0.73	0.73	0.69	0.61	0.92	0.56	0.40	0.22	0.73	0.60	0.58	0.55		0.49	0.32	0.15		0.56	0.42	0.29	0.95	0.65	n/a	n/a	
12-1/2 (318)	0.74	0.74	0.70	0.62	0.95	0.59	0.41	0.23	0.74	0.61	0.58	0.55		0.52	0.34	0.16		0.59	0.43	0.29	0.97	0.66	0.57	n/a	
14 (356)	0.76	0.76	0.72	0.63	1.00	0.66	0.46	0.25	0.77	0.62	0.59	0.55		0.62	0.40	0.19		0.66	0.47	0.31	1.00	0.70	0.60	n/a	
16 (406)	0.80	0.80	0.75	0.65		0.75	0.52	0.29	0.80	0.64	0.60	0.56		0.76	0.49	0.23		0.75	0.52	0.34		0.75	0.65	n/a	
18 (457)	0.84	0.84	0.79	0.67		0.84	0.59	0.32	0.84	0.66	0.62	0.57		0.91	0.59	0.27		0.84	0.59	0.36		0.79	0.68	n/a	
19-1/2 (495)	0.87	0.87	0.81	0.69		0.92	0.64	0.35	0.87	0.67	0.63	0.58		1.00	0.66	0.31		0.92	0.64	0.38		0.82	0.71	0.55	
20 (508)	0.88	0.88	0.82	0.69		0.94	0.65	0.36	0.88	0.67	0.63	0.58			0.69	0.32		0.94	0.65	0.39		0.83	0.72	0.56	
22 (559)	0.91	0.91	0.85	0.71		1.00	0.72	0.40	0.92	0.69	0.64	0.59			0.80	0.37		1.00	0.72	0.41		0.87	0.76	0.59	
24 (610)	0.95	0.95	0.88	0.73			0.78	0.43	0.96	0.71	0.66	0.59			0.91	0.42			0.78	0.44		0.91	0.79	0.61	
26 (660)	0.99	0.99	0.91	0.75			0.85	0.47	0.99	0.73	0.67	0.60			1.00	0.48			0.85	0.47		0.95	0.82	0.64	
28 (711)	1.00	1.00	0.94	0.77			0.91	0.50	1.00	0.74	0.68	0.61				0.53			0.91	0.50		0.99	0.85	0.66	
30 (762)			0.98	0.79			0.98	0.54		0.76	0.70	0.62							0.98	0.54		1.00	0.88	0.68	
36 (914)			1.00	0.84			1.00	0.65		0.81	0.73	0.64							1.00	0.65			0.97	0.75	
> 48 (1219)				0.96				0.86		0.92	0.81	0.69								0.86				1.00	0.87

Table 39 - Load adjustment factors for 7/8-in. diameter threaded rods in cracked concrete^{1,2,3}

Embedment h_{ef}	in. (mm)	Spacing factor in tension f_{AN}				Edge distance factor in tension f_{RN}				Spacing factor in shear ⁴ f_{AV}				Edge distance in shear								Concrete thickness factor in shear ⁵ f_{HV}			
														⊥ Toward edge f_{RV}				∥ To and away from edge f_{RV}							
		3-1/2	7-7/8	10-1/2	17-1/2	3-1/2	7-7/8	10-1/2	17-1/2	3-1/2	7-7/8	10-1/2	17-1/2	3-1/2	7-7/8	10-1/2	17-1/2	3-1/2	7-7/8	10-1/2	17-1/2	3-1/2	7-7/8	10-1/2	17-1/2
(89)	(200)	(267)	(445)	(89)	(200)	(267)	(445)	(89)	(200)	(267)	(445)	(89)	(200)	(267)	(445)	(89)	(200)	(267)	(445)	(89)	(200)	(267)	(445)		
1-3/4 (44)	n/a	n/a	n/a	n/a	0.42	0.42	0.41	0.38	n/a	n/a	n/a	n/a	0.09	0.03	0.02	0.01	0.18	0.06	0.04	0.02	n/a	n/a	n/a	n/a	
4-3/8 (111)	0.58	0.58	0.57	0.54	0.53	0.53	0.50	0.44	0.58	0.54	0.53	0.52	0.36	0.11	0.07	0.03	0.71	0.22	0.14	0.07	n/a	n/a	n/a	n/a	
5 (127)	0.59	0.59	0.58	0.55	0.56	0.56	0.52	0.45	0.60	0.54	0.53	0.52	0.43	0.13	0.09	0.04	0.87	0.27	0.17	0.08	n/a	n/a	n/a	n/a	
5-1/2 (140)	0.60	0.60	0.59	0.55	0.58	0.58	0.54	0.46	0.61	0.55	0.54	0.52	0.50	0.15	0.10	0.05	1.00	0.31	0.20	0.10	0.65	n/a	n/a	n/a	
6 (152)	0.61	0.61	0.60	0.56	0.61	0.61	0.56	0.47	0.61	0.55	0.54	0.52	0.57	0.18	0.11	0.06		0.35	0.23	0.11	0.68	n/a	n/a	n/a	
7 (178)	0.63	0.63	0.61	0.57	0.65	0.65	0.60	0.49	0.63	0.56	0.55	0.53	0.72	0.22	0.14	0.07		0.44	0.29	0.14	0.73	n/a	n/a	n/a	
8 (203)	0.65	0.65	0.63	0.58	0.71	0.71	0.64	0.52	0.65	0.57	0.55	0.53	0.88	0.27	0.18	0.09		0.54	0.35	0.17	0.78	n/a	n/a	n/a	
9 (229)	0.67	0.67	0.64	0.59	0.76	0.76	0.68	0.54	0.67	0.58	0.56	0.54	1.00	0.32	0.21	0.10		0.65	0.42	0.20	0.83	n/a	n/a	n/a	
9-7/8 (251)	0.69	0.69	0.66	0.59	0.80	0.80	0.72	0.56	0.69	0.59	0.56	0.54		0.37	0.24	0.12		0.74	0.48	0.23	0.87	0.59	n/a	n/a	
10 (254)	0.69	0.69	0.66	0.60	0.81	0.81	0.73	0.56	0.69	0.59	0.57	0.54		0.38	0.25	0.12		0.76	0.49	0.24	0.87	0.59	n/a	n/a	
11 (279)	0.71	0.71	0.67	0.60	0.87	0.87	0.77	0.59	0.71	0.60	0.57	0.54		0.44	0.28	0.14		0.87	0.57	0.28	0.92	0.62	n/a	n/a	
12 (305)	0.73	0.73	0.69	0.61	0.92	0.92	0.82	0.61	0.73	0.60	0.58	0.55		0.50	0.32	0.16		1.00	0.65	0.31	0.96	0.65	n/a	n/a	
12-1/2 (318)	0.74	0.74	0.70	0.62	0.95	0.95	0.84	0.62	0.74	0.61	0.58	0.55		0.53	0.34	0.17			0.69	0.33	0.98	0.66	0.57	n/a	
14 (356)	0.76	0.76	0.72	0.63	1.00	1.00	0.91	0.66	0.77	0.62	0.59	0.56		0.63	0.41	0.20			0.82	0.40	1.00	0.70	0.61	n/a	
16 (406)	0.80	0.80	0.75	0.65			1.00	0.71	0.81	0.64	0.60	0.56		0.77	0.50	0.24			1.00	0.48		0.75	0.65	n/a	
18 (457)	0.84	0.84	0.79	0.67				0.76	0.84	0.66	0.62	0.57		0.91	0.59	0.29				0.58		0.79	0.69	n/a	
19-1/2 (495)	0.87	0.87	0.81	0.69				0.80	0.87	0.67	0.63	0.58		1.00	0.67	0.32				0.65		0.82	0.71	0.56	
20 (508)	0.88	0.88	0.82	0.69				0.82	0.88	0.67	0.63	0.58			0.70	0.34				0.67		0.84	0.72	0.57	
22 (559)	0.91	0.91	0.85	0.71				0.87	0.92	0.69	0.64	0.59			0.80	0.39				0.78		0.88	0.76	0.60	
24 (610)	0.95	0.95	0.88	0.73				0.93	0.96	0.71	0.66	0.60			0.91	0.44				0.89		0.92	0.79	0.62	
26 (660)	0.99	0.99	0.91	0.75				0.99	1.00	0.73	0.67	0.61			1.00	0.50				0.99		0.95	0.82	0.65	
28 (711)	1.00	1.00	0.94	0.77				1.00		0.74	0.68	0.61				0.56				1.00		0.99	0.86	0.67	
30 (762)			0.98	0.79						0.76	0.70	0.62										1.00	0.89	0.70	
36 (914)			1.00	0.84						0.81	0.74	0.65											0.97	0.76	
> 48 (1219)				0.96						0.92	0.81	0.69											1.00	0.88	

1 Linear interpolation not permitted.

2 Shaded area with reduced edge distance is permitted provided the installation torque is reduced to 0.30 T_{max} for 5d ≤ s ≤ 16-in. and to 0.5 T_{max} for s > 16-in.

3 When combining multiple load adjustment factors (e.g. for a 4 anchor pattern in a corner with a thin concrete member) the design can become very conservative. To optimize the design, use Hilti PROFIS Anchor Design software or perform anchor calculation using the design equations from ACI 318 Chapter 17.

4 Spacing factor reduction in shear applicable when c < 3*h_{ef}. f_{AV} is applicable when edge distance, c < 3*h_{ef}. If c ≥ 3*h_{ef}, then f_{AV} = f_{AN}.

5 Concrete thickness reduction factor in shear, f_{HV}, is applicable when edge distance, c < 3*h_{ef}. If c ≥ 3*h_{ef}, then f_{HV} = 1.0.

Table 40 - Load adjustment factors for 1-in. diameter threaded rods in uncracked concrete^{1,2,3}

Embedment in. h _{ef} (mm)	Spacing factor in tension f _{AN}				Edge distance factor in tension f _{RN}				Spacing factor in shear ⁴ f _{AV}				Edge distance in shear								Concrete thickness factor in shear ⁵ f _{HV}			
													⊥ Toward edge f _{RV}				∥ To and away from edge f _{RV}							
	4	9	12	20	4	9	12	20	4	9	12	20	4	9	12	20	4	9	12	20	4	9	12	20
1-3/4 (44)	n/a	n/a	n/a	n/a	0.38	0.24	0.18	0.10	n/a	n/a	n/a	n/a	0.08	0.02	0.01	0.01	0.15	0.05	0.03	0.01	n/a	n/a	n/a	n/a
5 (127)	0.58	0.58	0.57	0.54	0.53	0.32	0.23	0.13	0.59	0.54	0.53	0.52	0.37	0.11	0.07	0.03	0.65	0.22	0.14	0.07	n/a	n/a	n/a	n/a
6 (152)	0.60	0.60	0.58	0.55	0.58	0.34	0.25	0.14	0.60	0.55	0.53	0.52	0.48	0.14	0.09	0.04	0.74	0.29	0.19	0.09	n/a	n/a	n/a	n/a
6-1/4 (159)	0.60	0.60	0.59	0.55	0.59	0.35	0.26	0.14	0.61	0.55	0.54	0.52	0.51	0.15	0.10	0.05	0.77	0.30	0.20	0.09	0.65	n/a	n/a	n/a
7 (178)	0.62	0.62	0.60	0.56	0.62	0.37	0.27	0.15	0.62	0.55	0.54	0.52	0.61	0.18	0.12	0.05	0.87	0.36	0.23	0.11	0.69	n/a	n/a	n/a
8 (203)	0.63	0.63	0.61	0.57	0.66	0.40	0.29	0.16	0.64	0.56	0.55	0.53	0.74	0.22	0.14	0.07	0.99	0.40	0.29	0.13	0.74	n/a	n/a	n/a
9 (229)	0.65	0.65	0.63	0.58	0.71	0.43	0.31	0.17	0.65	0.57	0.55	0.53	0.89	0.26	0.17	0.08	1.00	0.43	0.34	0.16	0.78	n/a	n/a	n/a
10 (254)	0.67	0.67	0.64	0.58	0.75	0.46	0.33	0.18	0.67	0.58	0.56	0.53	1.00	0.31	0.20	0.09		0.46	0.35	0.19	0.83	n/a	n/a	n/a
11 (279)	0.68	0.68	0.65	0.59	0.80	0.49	0.35	0.19	0.69	0.58	0.56	0.54		0.35	0.23	0.11		0.49	0.37	0.21	0.87	n/a	n/a	n/a
11-1/4 (286)	0.69	0.69	0.66	0.59	0.81	0.50	0.35	0.19	0.69	0.59	0.56	0.54		0.37	0.24	0.11		0.50	0.38	0.22	0.88	0.58	n/a	n/a
12 (305)	0.70	0.70	0.67	0.60	0.85	0.52	0.37	0.20	0.70	0.59	0.57	0.54		0.40	0.26	0.12		0.52	0.39	0.24	0.91	0.60	n/a	n/a
13 (330)	0.72	0.72	0.68	0.61	0.90	0.55	0.39	0.21	0.72	0.60	0.57	0.54		0.46	0.30	0.14		0.55	0.42	0.28	0.94	0.63	n/a	n/a
14 (356)	0.73	0.73	0.69	0.62	0.95	0.59	0.41	0.23	0.74	0.61	0.58	0.55		0.51	0.33	0.15		0.59	0.44	0.30	0.98	0.65	n/a	n/a
14-1/4 (362)	0.74	0.74	0.70	0.62	0.97	0.60	0.42	0.23	0.74	0.61	0.58	0.55		0.52	0.34	0.16		0.60	0.44	0.30	0.99	0.66	0.57	n/a
16 (406)	0.77	0.77	0.72	0.63	1.00	0.67	0.47	0.26	0.77	0.62	0.59	0.55		0.62	0.40	0.19		0.67	0.48	0.32	1.00	0.70	0.60	n/a
18 (457)	0.80	0.80	0.75	0.65		0.76	0.53	0.29	0.81	0.64	0.60	0.56		0.74	0.48	0.22		0.76	0.53	0.34		0.74	0.64	n/a
20 (508)	0.84	0.84	0.78	0.67		0.84	0.58	0.32	0.84	0.65	0.61	0.57		0.87	0.56	0.26		0.84	0.58	0.36		0.78	0.67	n/a
22 (559)	0.87	0.87	0.81	0.68		0.93	0.64	0.35	0.88	0.67	0.63	0.58		1.00	0.65	0.30		0.93	0.64	0.38		0.82	0.71	n/a
22-1/4 (565)	0.87	0.87	0.81	0.69		0.94	0.65	0.36	0.88	0.67	0.63	0.58			0.66	0.31		0.94	0.65	0.39		0.82	0.71	0.55
24 (610)	0.90	0.90	0.83	0.70		1.00	0.70	0.38	0.91	0.68	0.64	0.58			0.74	0.35		1.00	0.70	0.41		0.85	0.74	0.57
26 (660)	0.94	0.94	0.86	0.72			0.76	0.42	0.94	0.70	0.65	0.59			0.84	0.39			0.76	0.43		0.89	0.77	0.60
28 (711)	0.97	0.97	0.89	0.73			0.82	0.45	0.98	0.71	0.66	0.60			0.94	0.43			0.82	0.45		0.92	0.80	0.62
30 (762)	1.00	1.00	0.92	0.75			0.88	0.48	1.00	0.73	0.67	0.60			1.00	0.48			0.88	0.48		0.95	0.83	0.64
36 (914)			1.00	0.80			1.00	0.58		0.77	0.70	0.62				0.63			1.00	0.58		1.00	0.91	0.70
> 48 (1219)				0.90				0.77		0.86	0.77	0.66				0.98				0.77			1.00	0.81

3.2.3

Table 41 - Load adjustment factors for 1-in. diameter threaded rods in cracked concrete^{1,2,3}

Embedment in. h _{ef} (mm)	Spacing factor in tension f _{AN}				Edge distance factor in tension f _{RN}				Spacing factor in shear ⁴ f _{AV}				Edge distance in shear								Concrete thickness factor in shear ⁵ f _{HV}			
													⊥ Toward edge f _{RV}				∥ To and away from edge f _{RV}							
	4	9	12	20	4	9	12	20	4	9	12	20	4	9	12	20	4	9	12	20	4	9	12	20
1-3/4 (44)	n/a	n/a	n/a	n/a	0.41	0.41	0.40	0.38	n/a	n/a	n/a	n/a	0.08	0.02	0.01	0.01	0.15	0.05	0.03	0.01	n/a	n/a	n/a	n/a
5 (127)	0.58	0.58	0.57	0.54	0.53	0.53	0.50	0.44	0.59	0.54	0.53	0.52	0.37	0.11	0.07	0.03	0.74	0.22	0.14	0.07	n/a	n/a	n/a	n/a
6 (152)	0.60	0.60	0.58	0.55	0.58	0.58	0.53	0.46	0.60	0.55	0.53	0.52	0.49	0.14	0.09	0.04	0.97	0.29	0.19	0.09	n/a	n/a	n/a	n/a
6-1/4 (159)	0.60	0.60	0.59	0.55	0.59	0.59	0.54	0.46	0.61	0.55	0.54	0.52	0.52	0.15	0.10	0.05	1.00	0.31	0.20	0.09	0.66	n/a	n/a	n/a
7 (178)	0.62	0.62	0.60	0.56	0.62	0.62	0.57	0.47	0.62	0.55	0.54	0.52	0.61	0.18	0.12	0.05		0.36	0.24	0.11	0.69	n/a	n/a	n/a
8 (203)	0.63	0.63	0.61	0.57	0.66	0.66	0.60	0.49	0.64	0.56	0.55	0.53	0.75	0.22	0.14	0.07		0.44	0.29	0.13	0.74	n/a	n/a	n/a
9 (229)	0.65	0.65	0.63	0.58	0.71	0.71	0.64	0.51	0.65	0.57	0.55	0.53	0.89	0.26	0.17	0.08		0.53	0.34	0.16	0.79	n/a	n/a	n/a
10 (254)	0.67	0.67	0.64	0.58	0.75	0.75	0.67	0.53	0.67	0.58	0.56	0.53	1.00	0.31	0.20	0.09		0.62	0.40	0.19	0.83	n/a	n/a	n/a
11 (279)	0.68	0.68	0.65	0.59	0.80	0.80	0.71	0.55	0.69	0.58	0.56	0.54		0.36	0.23	0.11		0.72	0.46	0.22	0.87	n/a	n/a	n/a
11-1/4 (286)	0.69	0.69	0.66	0.59	0.81	0.81	0.72	0.56	0.69	0.59	0.56	0.54		0.37	0.24	0.11		0.74	0.48	0.22	0.88	0.59	n/a	n/a
12 (305)	0.70	0.70	0.67	0.60	0.85	0.85	0.75	0.57	0.71	0.59	0.57	0.54		0.41	0.26	0.12		0.82	0.53	0.25	0.91	0.61	n/a	n/a
13 (330)	0.72	0.72	0.68	0.61	0.90	0.90	0.79	0.59	0.72	0.60	0.57	0.54		0.46	0.30	0.14		0.92	0.60	0.28	0.95	0.63	n/a	n/a
14 (356)	0.73	0.73	0.69	0.62	0.95	0.95	0.83	0.62	0.74	0.61	0.58	0.55		0.51	0.33	0.16		1.00	0.67	0.31	0.98	0.65	n/a	n/a
14-1/4 (362)	0.74	0.74	0.70	0.62	0.97	0.97	0.84	0.62	0.74	0.61	0.58	0.55		0.53	0.34	0.16			0.69	0.32	0.99	0.66	0.57	n/a
16 (406)	0.77	0.77	0.72	0.63	1.00	1.00	0.91	0.66	0.77	0.62	0.59	0.55		0.63	0.41	0.19			0.82	0.38	1.00	0.70	0.61	n/a
18 (457)	0.80	0.80	0.75	0.65			1.00	0.70	0.81	0.64	0.60	0.56		0.75	0.49	0.23			0.97	0.45		0.74	0.64	n/a
20 (508)	0.84	0.84	0.78	0.67				0.75	0.84	0.65	0.61	0.57		0.88	0.57	0.26			1.00	0.53		0.78	0.68	n/a
22 (559)	0.87	0.87	0.81	0.68				0.80	0.88	0.67	0.63	0.58		1.00	0.66	0.31				0.61		0.82	0.71	n/a
22-1/4 (565)	0.87	0.87	0.81	0.69				0.80	0.88	0.67	0.63	0.58			0.67	0.31				0.62		0.82	0.71	0.55
24 (610)	0.90	0.90	0.83	0.70				0.85	0.91	0.68	0.64	0.58			0.75	0.35				0.70		0.86	0.74	0.57
26 (660)	0.94	0.94	0.86	0.72				0.90	0.95	0.70	0.65	0.59			0.84	0.39				0.78		0.89	0.77	0.60
28 (711)	0.97	0.97	0.89	0.73				0.95	0.98	0.71	0.66	0.60			0.94	0.44				0.88		0.92	0.80	0.62
30 (762)	1.00	1.00	0.92	0.75				1.00	1.00	0.73	0.67	0.60			1.00	0.49				0.97		0.96	0.83	0.64
36 (914)			1.00	0.80						0.77	0.71	0.62				0.64				1.00		1.00	0.91	0.70
> 48 (1219)				0.90						0.87	0.77	0.66				0.98							1.00	0.81

- Linear interpolation not permitted.
- Shaded area with reduced edge distance is permitted provided the installation torque is reduced to 0.30 T_{max} for 5d ≤ s ≤ 16-in. and to 0.5 T_{max} for s > 16-in.
- When combining multiple load adjustment factors (e.g. for a 4 anchor pattern in a corner with a thin concrete member) the design can become very conservative. To optimize the design, use Hilti PROFIS Anchor Design software or perform anchor calculation using the design equations from ACI 318 Chapter 17.
- Spacing factor reduction in shear applicable when c < 3*h_{ef}. f_{AV} is applicable when edge distance, c < 3*h_{ef}. If c ≥ 3*h_{ef}, then f_{AV} = f_{AN}.
- Concrete thickness reduction factor in shear, f_{HV} is applicable when edge distance, c < 3*h_{ef}. If c ≥ 3*h_{ef}, then f_{HV} = 1.0.

Table 42 - Load adjustment factors for 1-1/4-in. diameter threaded rods in uncracked concrete^{1,2,3}

Embedment h_{ef} in. (mm)	Spacing factor in tension f_{AN}				Edge distance factor in tension f_{RN}				Spacing factor in shear ⁴ f_{AV}				Edge distance in shear								Concrete thickness factor in shear ⁵ f_{HV}			
													⊥ Toward edge f_{RV}				∥ To and away from edge f_{RV}							
	5	11-1/4	15	25	5	11-1/4	15	25	5	11-1/4	15	25	5	11-1/4	15	25	5	11-1/4	15	25	5	11-1/4	15	25
1-3/4 (44)	n/a	n/a	n/a	n/a	0.37	0.24	0.17	0.09	n/a	n/a	n/a	n/a	0.05	0.02	0.01	0.00	0.11	0.03	0.02	0.01	n/a	n/a	n/a	n/a
6-1/4 (159)	0.59	0.59	0.57	0.54	0.54	0.33	0.24	0.13	0.59	0.54	0.53	0.52	0.37	0.11	0.07	0.03	0.67	0.22	0.14	0.07	n/a	n/a	n/a	n/a
7 (178)	0.60	0.60	0.58	0.55	0.57	0.35	0.25	0.13	0.60	0.54	0.53	0.52	0.43	0.13	0.08	0.04	0.73	0.26	0.17	0.08	n/a	n/a	n/a	n/a
8 (203)	0.61	0.61	0.59	0.55	0.61	0.37	0.26	0.14	0.61	0.55	0.54	0.52	0.53	0.16	0.10	0.05	0.82	0.31	0.20	0.10	0.66	n/a	n/a	n/a
9 (229)	0.63	0.63	0.60	0.56	0.64	0.39	0.28	0.15	0.62	0.55	0.54	0.52	0.63	0.19	0.12	0.06	0.93	0.38	0.24	0.11	0.70	n/a	n/a	n/a
10 (254)	0.64	0.64	0.61	0.57	0.68	0.41	0.29	0.16	0.64	0.56	0.55	0.53	0.74	0.22	0.14	0.07	1.00	0.41	0.29	0.13	0.74	n/a	n/a	n/a
11 (279)	0.65	0.65	0.62	0.57	0.72	0.44	0.31	0.17	0.65	0.57	0.55	0.53	0.86	0.25	0.16	0.08	0.44	0.33	0.15	0.78	n/a	n/a	n/a	
12 (305)	0.67	0.67	0.63	0.58	0.76	0.46	0.33	0.18	0.66	0.57	0.55	0.53	0.98	0.29	0.19	0.09	0.46	0.36	0.17	0.81	n/a	n/a	n/a	
13 (330)	0.68	0.68	0.64	0.59	0.80	0.49	0.35	0.19	0.68	0.58	0.56	0.54	1.00	0.33	0.21	0.10	0.49	0.38	0.20	0.84	n/a	n/a	n/a	
14 (356)	0.70	0.70	0.66	0.59	0.84	0.52	0.36	0.20	0.69	0.59	0.56	0.54	0.36	0.24	0.11	0.52	0.40	0.22	0.87	0.58	n/a	n/a	n/a	
14-1/4 (362)	0.70	0.70	0.66	0.60	0.85	0.52	0.37	0.20	0.69	0.59	0.56	0.54	0.37	0.24	0.11	0.52	0.40	0.23	0.88	0.59	n/a	n/a	n/a	
15 (381)	0.71	0.71	0.67	0.60	0.88	0.54	0.38	0.21	0.70	0.59	0.57	0.54	0.40	0.26	0.12	0.54	0.41	0.24	0.91	0.60	n/a	n/a	n/a	
16 (406)	0.72	0.72	0.68	0.61	0.92	0.57	0.40	0.22	0.72	0.60	0.57	0.54	0.45	0.29	0.13	0.57	0.43	0.27	0.94	0.62	n/a	n/a	n/a	
17 (432)	0.74	0.74	0.69	0.61	0.96	0.60	0.42	0.23	0.73	0.60	0.58	0.55	0.49	0.32	0.15	0.60	0.45	0.29	0.96	0.64	n/a	n/a	n/a	
18 (457)	0.75	0.75	0.70	0.62	1.00	0.63	0.44	0.24	0.75	0.61	0.58	0.55	0.53	0.35	0.16	0.63	0.47	0.31	0.99	0.66	0.57	n/a	n/a	
20 (508)	0.78	0.78	0.72	0.63	0.70	0.49	0.27	0.27	0.77	0.62	0.59	0.55	0.62	0.40	0.19	0.70	0.50	0.33	1.00	0.70	0.60	n/a	n/a	
22 (559)	0.81	0.81	0.74	0.65	0.77	0.54	0.29	0.29	0.80	0.63	0.60	0.56	0.72	0.47	0.22	0.77	0.54	0.35	0.73	0.63	n/a	n/a	n/a	
24 (610)	0.84	0.84	0.77	0.66	0.84	0.59	0.32	0.32	0.83	0.65	0.61	0.57	0.82	0.53	0.25	0.84	0.59	0.36	0.76	0.66	n/a	n/a	n/a	
26 (660)	0.87	0.87	0.79	0.67	0.91	0.64	0.34	0.34	0.86	0.66	0.62	0.57	0.92	0.60	0.28	0.91	0.64	0.38	0.79	0.69	n/a	n/a	n/a	
28 (711)	0.89	0.89	0.81	0.69	0.98	0.68	0.37	0.37	0.88	0.67	0.63	0.58	1.00	0.67	0.31	0.98	0.68	0.40	0.82	0.71	0.55	n/a	n/a	
30 (762)	0.92	0.92	0.83	0.70	1.00	0.73	0.40	0.40	0.91	0.68	0.64	0.58	0.74	0.35	0.25	1.00	0.73	0.42	0.85	0.74	0.57	n/a	n/a	
36 (914)	1.00	1.00	0.90	0.74	0.88	0.48	0.48	0.48	0.99	0.72	0.66	0.60	0.98	0.45	0.25	0.88	0.48	0.25	0.94	0.81	0.63	n/a	n/a	
> 48 (1219)			1.00	0.82	1.00	0.64	0.64	0.64	1.00	0.79	0.72	0.63	1.00	0.70	0.63	1.00	0.64	0.64	1.00	0.94	0.72	n/a	n/a	

Table 43 - Load adjustment factors for 1-1/4-in. diameter threaded rods in cracked concrete^{1,2,3}











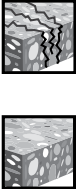

Embedment h_{ef} in. (mm)	Spacing factor in tension f_{AN}				Edge distance factor in tension f_{RN}				Spacing factor in shear ⁴ f_{AV}				Edge distance in shear								Concrete thickness factor in shear ⁵ f_{HV}			
													⊥ Toward edge f_{RV}				∥ To and away from edge f_{RV}							
	5	11-1/4	15	25	5	11-1/4	15	25	5	11-1/4	15	25	5	11-1/4	15	25	5	11-1/4	15	25	5	11-1/4	15	25
1-3/4 (44)	n/a	n/a	n/a	n/a	0.40	0.40	0.39	0.37	n/a	n/a	n/a	n/a	0.05	0.02	0.01	0.00	0.11	0.03	0.02	0.01	n/a	n/a	n/a	n/a
6-1/4 (159)	0.59	0.59	0.57	0.54	0.54	0.33	0.24	0.13	0.59	0.54	0.53	0.52	0.37	0.11	0.07	0.03	0.74	0.22	0.14	0.07	n/a	n/a	n/a	n/a
7 (178)	0.60	0.60	0.58	0.55	0.57	0.35	0.25	0.13	0.60	0.54	0.53	0.52	0.44	0.13	0.08	0.04	0.88	0.26	0.17	0.08	n/a	n/a	n/a	n/a
8 (203)	0.61	0.61	0.59	0.55	0.61	0.37	0.26	0.14	0.61	0.55	0.54	0.52	0.54	0.16	0.10	0.05	1.00	0.32	0.21	0.10	0.66	n/a	n/a	n/a
9 (229)	0.63	0.63	0.60	0.56	0.64	0.39	0.28	0.15	0.62	0.55	0.54	0.52	0.64	0.19	0.12	0.06	0.38	0.25	0.11	0.70	n/a	n/a	n/a	
10 (254)	0.64	0.64	0.61	0.57	0.68	0.41	0.29	0.16	0.64	0.56	0.55	0.53	0.75	0.22	0.14	0.07	0.44	0.29	0.13	0.74	n/a	n/a	n/a	
11 (279)	0.65	0.65	0.62	0.57	0.72	0.44	0.31	0.17	0.65	0.57	0.55	0.53	0.86	0.26	0.17	0.08	0.51	0.33	0.15	0.78	n/a	n/a	n/a	
12 (305)	0.67	0.67	0.63	0.58	0.76	0.46	0.33	0.18	0.66	0.57	0.55	0.53	0.98	0.29	0.19	0.09	0.58	0.38	0.18	0.81	n/a	n/a	n/a	
13 (330)	0.68	0.68	0.64	0.59	0.80	0.49	0.35	0.19	0.68	0.58	0.56	0.54	1.00	0.33	0.21	0.10	0.66	0.43	0.20	0.85	n/a	n/a	n/a	
14 (356)	0.70	0.70	0.66	0.59	0.84	0.52	0.36	0.20	0.69	0.59	0.56	0.54	0.37	0.24	0.11	0.52	0.40	0.22	0.87	0.58	n/a	n/a	n/a	
14-1/4 (362)	0.70	0.70	0.66	0.60	0.85	0.52	0.37	0.20	0.69	0.59	0.56	0.54	0.37	0.24	0.11	0.52	0.40	0.23	0.88	0.59	n/a	n/a	n/a	
15 (381)	0.71	0.71	0.67	0.60	0.88	0.54	0.38	0.21	0.70	0.59	0.57	0.54	0.40	0.26	0.12	0.54	0.41	0.24	0.91	0.60	n/a	n/a	n/a	
16 (406)	0.72	0.72	0.68	0.61	0.92	0.57	0.40	0.22	0.72	0.60	0.57	0.54	0.45	0.29	0.13	0.57	0.43	0.27	0.94	0.62	n/a	n/a	n/a	
17 (432)	0.74	0.74	0.69	0.61	0.96	0.60	0.42	0.23	0.73	0.60	0.58	0.55	0.49	0.32	0.15	0.60	0.45	0.29	0.96	0.64	n/a	n/a	n/a	
18 (457)	0.75	0.75	0.70	0.62	1.00	0.63	0.44	0.24	0.75	0.61	0.58	0.55	0.53	0.35	0.16	0.63	0.47	0.31	0.99	0.66	0.57	n/a	n/a	
20 (508)	0.78	0.78	0.72	0.63	0.70	0.49	0.27	0.27	0.77	0.62	0.59	0.55	0.62	0.40	0.19	0.70	0.50	0.33	1.00	0.70	0.60	n/a	n/a	
22 (559)	0.81	0.81	0.74	0.65	0.77	0.54	0.29	0.29	0.80	0.63	0.60	0.56	0.72	0.47	0.22	0.77	0.54	0.35	0.73	0.63	n/a	n/a	n/a	
24 (610)	0.84	0.84	0.77	0.66	0.84	0.59	0.32	0.32	0.83	0.65	0.61	0.57	0.82	0.53	0.25	0.84	0.59	0.36	0.76	0.66	n/a	n/a	n/a	
26 (660)	0.87	0.87	0.79	0.67	0.91	0.64	0.34	0.34	0.86	0.66	0.62	0.57	0.92	0.60	0.28	0.91	0.64	0.38	0.79	0.69	n/a	n/a	n/a	
28 (711)	0.89	0.89	0.81	0.69	0.98	0.68	0.37	0.37	0.88	0.67	0.63	0.58	1.00	0.67	0.31	0.98	0.68	0.40	0.82	0.71	0.55	n/a	n/a	
30 (762)	0.92	0.92	0.83	0.70	1.00	0.73	0.40	0.40	0.91	0.68	0.64	0.58	0.74	0.35	0.25	1.00	0.73	0.42	0.85	0.74	0.57	n/a	n/a	
36 (914)	1.00	1.00	0.90	0.74	0.88	0.48	0.48	0.48	0.99	0.72	0.66	0.60	0.98	0.45	0.25	0.88	0.48	0.25	0.94	0.81	0.63	n/a	n/a	
> 48 (1219)			1.00	0.82	1.00	0.64	0.64	0.64	1.00	0.79	0.72	0.63	1.00	0.70	0.63	1.00	0.64	0.64	1.00	0.94	0.72	n/a	n/a	

1 Linear interpolation not permitted.
2 Shaded area with reduced edge distance is permitted provided the installation torque is reduced to 0.30 T_{max} for 5d ≤ s ≤ 16-in. and to 0.5 T_{max} for s > 16-in.
3 When combining multiple load adjustment factors (e.g. for a 4 anchor pattern in a corner with a thin concrete member) the design can become very conservative. To optimize the design, use Hilti PROFIS Anchor Design software or perform anchor calculation using the design equations from ACI 318 Chapter 17.
4 Spacing factor reduction in shear applicable when c < 3*h_{ef}. f_{AV} is applicable when edge distance, c < 3*h_{ef}. If c ≥ 3*h_{ef}, then f_{AV} = f_{AN}.
5 Concrete thickness reduction factor in shear, f_{HV}, is applicable when edge distance, c < 3*h_{ef}. If c ≥ 3*h_{ef}, then f_{HV} = 1.0.

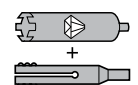
HIT-RE 500 V3 adhesive with HIS-N and HIS-RN internally threaded insert



Figure 7 - Hilti HIS-N and HIS-RN internally threaded insert installation conditions

Cracked or uncracked concrete	Permissible drilling methods	Permissible concrete conditions
 <p>Cracked and uncracked concrete</p>	 <p>Hammer drilling with carbide-tipped drill bit</p>	 Dry concrete  Water-saturated concrete  Water-filled holes  Submerged (underwater)
	  <p>Hilti TE-CD or TE-YD hollow drill bit Diamond core drill bit with Hilti TE-YRT roughening tool</p>	 Dry concrete  Water-saturated concrete
 <p>Uncracked concrete</p>	 <p>Diamond core drill bit</p>	 Dry concrete  Water-saturated concrete

3.2.3

Table 44 - HIS-N and HIS-RN specifications

Setting information	Symbol	Units	Thread size			
			3/8-16 UNC	1/2-13 UNC	5/8-11 UNC	3/4-10 UNC
Outside diameter of insert		in.	0.65	0.81	1.00	1.09
Nominal bit diameter	d_o	in.	11/16	7/8	1-1/8	1-1/4
Effective embedment	h_{ef}	in. (mm)	4-3/8 (110)	5 (125)	6-3/4 (170)	8-1/8 (205)
Thread engagement	minimum maximum	h_s	3/8	1/2	5/8	3/4
		h_s	15/16	1-3/16	1-1/2	1-7/8
Installation torque	T_{inst}	ft-lb (Nm)	15 (20)	30 (40)	60 (81)	100 (136)
Minimum concrete thickness	h_{min}	in. (mm)	5.9 (150)	6.7 (170)	9.1 (230)	10.6 (270)
Minimum edge distance	c_{min}	in (mm)	3-1/4 (83)	4 (102)	5 (127)	5-1/2 (140)
Minimum anchor spacing	s_{min}	in (mm)	3-1/4 (83)	4 (102)	5 (127)	5-1/2 (140)

Figure 8 - Hilti HIS-N and HIS-RN specifications

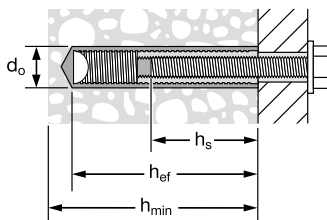

Table 45 - Hilti HIT-RE 500 V3 adhesive design strength with concrete / bond failure for Hilti HIS-N and HIS-RN internally threaded inserts in uncracked concrete^{1,2,3,4,5,6,7,8,9,11}

Thread size	Effective embedment in. (mm)	Tension — ΦN_n				Shear — ΦV_n			
		$f'_c = 2,500$ psi (17.2 MPa) lb (kN)	$f'_c = 3,000$ psi (20.7 MPa) lb (kN)	$f'_c = 4,000$ psi (27.6 MPa) lb (kN)	$f'_c = 6,000$ psi (41.4 MPa) lb (kN)	$f'_c = 2,500$ psi (17.2 MPa) lb (kN)	$f'_c = 3,000$ psi (20.7 MPa) lb (kN)	$f'_c = 4,000$ psi (27.6 MPa) lb (kN)	$f'_c = 6,000$ psi (41.4 MPa) lb (kN)
3/8-16 UNC	4-3/8 (111)	7,140 (31.8)	7,820 (34.8)	9,030 (40.2)	11,060 (49.2)	15,375 (68.4)	16,840 (74.9)	19,445 (86.5)	23,815 (105.9)
1/2-13 ¹⁰ UNC	5 (127)	8,720 (38.8)	9,555 (42.5)	11,030 (49.1)	13,510 (60.1)	18,785 (83.6)	20,575 (91.5)	23,760 (105.7)	29,100 (129.4)
5/8-11 ¹⁰ UNC	6-3/4 (171)	13,680 (60.9)	14,985 (66.7)	17,305 (77.0)	21,190 (94.3)	29,460 (131.0)	32,275 (143.6)	37,265 (165.8)	45,645 (203.0)
3/4-10 ¹⁰ UNC	8-1/8 (206)	18,065 (80.4)	19,790 (88.0)	22,850 (101.6)	27,985 (124.5)	38,910 (173.1)	42,620 (189.6)	49,215 (218.9)	60,275 (268.1)

Table 46 - Hilti HIT-RE 500 V3 adhesive design strength with concrete / bond failure for Hilti HIS-N and HIS-RN internally threaded inserts in cracked concrete^{1,2,3,4,5,6,7,8,9,11}

Thread size	Effective embedment in. (mm)	Tension — ΦN_n				Shear — ΦV_n			
		$f'_c = 2,500$ psi (17.2 MPa) lb (kN)	$f'_c = 3,000$ psi (20.7 MPa) lb (kN)	$f'_c = 4,000$ psi (27.6 MPa) lb (kN)	$f'_c = 6,000$ psi (41.4 MPa) lb (kN)	$f'_c = 2,500$ psi (17.2 MPa) lb (kN)	$f'_c = 3,000$ psi (20.7 MPa) lb (kN)	$f'_c = 4,000$ psi (27.6 MPa) lb (kN)	$f'_c = 6,000$ psi (41.4 MPa) lb (kN)
3/8-16 UNC	4-3/8 (111)	5,055 (22.5)	5,540 (24.6)	6,395 (28.4)	7,085 (31.5)	10,890 (48.4)	11,930 (53.1)	13,775 (61.3)	15,260 (67.9)
1/2-13 ¹⁰ UNC	5 (127)	6,175 (27.5)	6,765 (30.1)	7,815 (34.8)	9,570 (42.6)	13,305 (59.2)	14,575 (64.8)	16,830 (74.9)	20,610 (91.7)
5/8-11 ¹⁰ UNC	6-3/4 (171)	9,890 (43.1)	10,615 (47.2)	12,255 (54.5)	15,010 (66.8)	20,870 (92.8)	22,860 (101.7)	26,395 (117.4)	32,330 (143.8)
3/4-10 ¹⁰ UNC	8-1/8 (206)	12,795 (56.9)	14,015 (62.3)	16,185 (72.0)	19,825 (88.2)	27,560 (122.6)	30,190 (134.3)	34,860 (155.1)	42,695 (189.9)

- See Section 3.1.8 for explanation on development of load values.
- See Section 3.1.8 to convert design strength (factored resistance) value to ASD value.
- Linear interpolation between embedment depths and concrete compressive strengths is not permitted.
- Apply spacing, edge distance, and concrete thickness factors in tables 50 and 51 as necessary to the above values. Compare to the steel values in table 49. The lesser of the values is to be used for the design.
- Data is for temperature range A: Max. short term temperature = 130° F (55° C), max. long term temperature = 110° F (43° C).
For temperature range B: Max. short term temperature = 176° F (80° C), max. long term temperature = 110° F (43° C) multiply above values by 0.69
Short term elevated concrete temperatures are those that occur over brief intervals, e.g., as a result of diurnal cycling. Long term concrete temperatures are roughly constant over significant periods of time.
- Tabular values are for dry concrete and water saturated concrete conditions.
For water-filled drilled holes multiply design strength by 0.52.
For submerged (under water) applications multiply design strength by 0.46.
- Tabular values are for short term loads only. For sustained loads including overhead use, see Section 3.1.8.
- Tabular values are for normal-weight concrete only. For lightweight concrete multiply design strength by λ_a as follows:
For sand-lightweight, $\lambda_a = 0.51$. For all-lightweight, $\lambda_a = 0.45$.
- Tabular values are for holes drilled in concrete with carbide tipped hammer drill bit. Diamond core drilling is not permitted in cracked concrete except as indicated in note 10. For diamond core drilling in uncracked concrete, except as indicated in note 10, multiply the above values by 0.57. Diamond core drilling is not permitted for water-filled or under-water (submerged) applications in uncracked concrete.
- Diamond core drilling is permitted in uncracked and cracked concrete with use of the Hilti TE-YRT roughening tool for 1/2-13 UNC, 5/8-11 UNC, and 3/4-10 UNC anchors in dry and water-saturated concrete. See Tables 47 and 48.
- Tabular values are for static loads only. Seismic design is not permitted for uncracked concrete. For seismic loads, multiply cracked concrete tabular values in tension and shear by $\alpha_{seis} = 0.75$. See section 3.1.8 for additional information on seismic applications.

Table 47 - Hilti HIT-RE 500 V3 in Core Drilled Holes roughened with TE-YRT Roughening Tool adhesive design strength with concrete / bond failure for Hilti HIS-N and HIS-RN internally threaded inserts in uncracked concrete^{1,2,3,4,5,6,7,8}

Thread size	Effective embedment in. (mm)	Tension — ΦN_n				Shear — ΦV_n			
		$f'_c = 2,500$ psi (17.2 MPa) lb (kN)	$f'_c = 3,000$ psi (20.7 MPa) lb (kN)	$f'_c = 4,000$ psi (27.6 MPa) lb (kN)	$f'_c = 6,000$ psi (41.4 MPa) lb (kN)	$f'_c = 2,500$ psi (17.2 MPa) lb (kN)	$f'_c = 3,000$ psi (20.7 MPa) lb (kN)	$f'_c = 4,000$ psi (27.6 MPa) lb (kN)	$f'_c = 6,000$ psi (41.4 MPa) lb (kN)
1/2-13 UNC	5 (127)	8,720 (38.8)	9,555 (42.5)	11,030 (49.1)	13,510 (60.1)	18,785 (83.6)	20,575 (91.5)	23,760 (105.7)	29,100 (129.4)
5/8-11 UNC	6-3/4 (171)	13,680 (60.9)	14,985 (66.7)	17,305 (77.0)	21,190 (94.3)	29,460 (131.0)	32,275 (143.6)	37,265 (165.8)	45,645 (203.0)
3/4-10 UNC	8-1/8 (206)	18,065 (80.4)	19,790 (88.0)	22,850 (101.6)	27,985 (124.5)	38,910 (173.1)	42,620 (189.6)	49,215 (218.9)	60,275 (268.1)

Table 48 - Hilti HIT-RE 500 V3 in Core Drilled Holes roughened with TE-YRT Roughening Tool adhesive design strength with concrete / bond failure for Hilti HIS-N and HIS-RN internally threaded inserts in cracked concrete^{1,2,3,4,5,6,7,8,9}

Thread size	Effective embedment in. (mm)	Tension — ΦN_n				Shear — ΦV_n			
		$f'_c = 2,500$ psi (17.2 MPa) lb (kN)	$f'_c = 3,000$ psi (20.7 MPa) lb (kN)	$f'_c = 4,000$ psi (27.6 MPa) lb (kN)	$f'_c = 6,000$ psi (41.4 MPa) lb (kN)	$f'_c = 2,500$ psi (17.2 MPa) lb (kN)	$f'_c = 3,000$ psi (20.7 MPa) lb (kN)	$f'_c = 4,000$ psi (27.6 MPa) lb (kN)	$f'_c = 6,000$ psi (41.4 MPa) lb (kN)
1/2-13 UNC	5 (127)	6,175 (27.5)	6,205 (27.6)	6,205 (27.6)	6,205 (27.6)	13,305 (59.2)	13,360 (59.4)	13,360 (59.4)	13,360 (59.4)
5/8-11 UNC	6-3/4 (171)	9,680 (43.1)	10,340 (46.0)	10,340 (46.0)	10,340 (46.0)	20,870 (92.8)	22,265 (99.0)	22,265 (99.0)	22,265 (99.0)
3/4-10 UNC	8-1/8 (206)	12,795 (56.9)	13,565 (60.3)	13,565 (60.3)	13,565 (60.3)	27,560 (122.6)	29,215 (130.0)	29,215 (130.0)	29,215 (130.0)

- See Section 3.1.8 for explanation on development of load values.
- See Section 3.1.8 to convert design strength (factored resistance) value to ASD value.
- Linear interpolation between embedment depths and concrete compressive strengths is not permitted.
- Apply spacing, edge distance, and concrete thickness factors in tables 50 and 51 as necessary to the above values. Compare to the steel values in table 49. The lesser of the values is to be used for the design.
- Data is for temperature range A: Max. short term temperature = 130° F (55° C), max. long term temperature = 110° F (43° C). For temperature range B: Max. short term temperature = 176° F (80° C), max. long term temperature = 110° F (43° C) multiply above values by 0.69. Short term elevated concrete temperatures are those that occur over brief intervals, e.g., as a result of diurnal cycling. Long term concrete temperatures are roughly constant over significant periods of time.
- Tabular values are for dry concrete and water saturated concrete conditions. Water-filled and submerged (underwater) applications are not permitted for this hole preparation method.
- Tabular values are for short term loads only. For sustained loads including overhead use, see Section 3.1.8.
- Tabular values are for normal-weight concrete only. For lightweight concrete multiply design strength by λ_a as follows: For sand-lightweight, $\lambda_a = 0.51$. For all-lightweight, $\lambda_a = 0.45$.
- Tabular values are for static loads only. Seismic design is not permitted for uncracked concrete. For seismic loads, multiply cracked concrete tabular values in tension and shear by $\alpha_{seis} = 0.75$. See section 3.1.8 for additional information on seismic applications.

3.2.3

Table 49 - Steel design strength for steel bolt / cap screw for Hilti HIS-N and HIS-RN internally threaded inserts^{1,2,3}

Thread size	ASTM A 193 B7			ASTM A 193 Grade B8M stainless steel		
	Tensile ⁴ ΦN_{sa} lb (kN)	Shear ⁵ ΦV_{sa} lb (kN)	Seismic Shear ⁶ $\Phi V_{sa,eq}$ lb (kN)	Tensile ⁴ ΦN_{sa} lb (kN)	Shear ⁵ ΦV_{sa} lb (kN)	Seismic Shear ⁶ $\Phi V_{sa,eq}$ lb (kN)
3/8-16 UNC	6,300 (28.0)	3,490 (15.5)	2,445 (10.9)	5,540 (24.6)	3,070 (13.7)	2,150 (9.6)
1/2-13 UNC	10,525 (46.8)	6,385 (28.4)	4,470 (19.9)	10,145 (45.1)	5,620 (25.0)	3,935 (17.5)
5/8-11 UNC	17,500 (77.8)	10,170 (45.2)	7,120 (31.7)	16,160 (71.9)	8,950 (39.8)	6,265 (27.9)
3/4-10 UNC	17,785 (79.1)	15,055 (67.0)	10,540 (46.9)	23,915 (106.4)	13,245 (58.9)	9,270 (41.2)

- See Section 3.1.8 to convert design strength value to ASD value.
- Hilti HIS-N and HIS-RN inserts with steel bolts are considered brittle steel elements.
- Table values are the lesser of steel failure in the HIS-N insert or inserted steel bolt.
- Tensile = $\Phi A_{sa,N} f_{uta}$ as noted in ACI 318 Chapter 17.
- Shear = $\Phi 0.60 A_{se,V} f_{uta}$ as noted in ACI 318 Chapter 17.
- Seismic Shear = $\alpha_{seis} \Phi V_{sa}$: Reduction for seismic shear only. See section 3.1.8 for additional information on seismic applications.

Table 50 - Load adjustment factors for Hilti HIS-N and HIS-RN internally threaded inserts in uncracked concrete^{1,2}

HIS-N and HIS-RN all diameters uncracked concrete	Spacing factor in tension f_{AN}				Edge distance factor in tension f_{RN}				Spacing factor in shear ³ f_{AV}				Edge Distance in Shear								Concrete thickness factor in shear ⁴ f_{HV}				
													⊥ Toward edge f_{RV}				∥ To and away from edge f_{RV}								
	Internal diameter (mm)	3/8 (9.5)	1/2 (12.7)	5/8 (15.9)	3/4 (19.1)	3/8 (9.5)	1/2 (12.7)	5/8 (15.9)	3/4 (19.1)	3/8 (9.5)	1/2 (12.7)	5/8 (15.9)	3/4 (19.1)	3/8 (9.5)	1/2 (12.7)	5/8 (15.9)	3/4 (19.1)	3/8 (9.5)	1/2 (12.7)	5/8 (15.9)	3/4 (19.1)	3/8 (9.5)	1/2 (12.7)	5/8 (15.9)	3/4 (19.1)
Embedment h_{ef} (mm)	4-3/8 (111)	5 (127)	6-3/4 (171)	8-1/8 (206)	4-3/8 (111)	5 (127)	6-3/4 (171)	8-1/8 (206)	4-3/8 (111)	5 (127)	6-3/4 (171)	8-1/8 (206)	4-3/8 (111)	5 (127)	6-3/4 (171)	8-1/8 (206)	4-3/8 (111)	5 (127)	6-3/4 (171)	8-1/8 (206)	4-3/8 (111)	5 (127)	6-3/4 (171)	8-1/8 (206)	
3-1/4 (83)	0.59	n/a	n/a	n/a	0.36	n/a	n/a	n/a	0.55	n/a	n/a	n/a	0.15	n/a	n/a	n/a	0.31	n/a	n/a	n/a	n/a	n/a	n/a	n/a	n/a
4 (102)	0.61	0.59	n/a	n/a	0.41	0.40	n/a	n/a	0.56	0.55	n/a	n/a	0.21	0.19	n/a	n/a	0.41	0.38	n/a	n/a	n/a	n/a	n/a	n/a	n/a
5 (127)	0.64	0.61	0.59	n/a	0.47	0.45	0.39	n/a	0.57	0.57	0.55	n/a	0.29	0.26	0.17	n/a	0.47	0.45	0.33	n/a	n/a	n/a	n/a	n/a	n/a
5-1/2 (140)	0.65	0.62	0.60	0.59	0.50	0.48	0.41	0.37	0.58	0.58	0.56	0.55	0.34	0.30	0.19	0.15	0.50	0.48	0.39	0.29	n/a	n/a	n/a	n/a	n/a
6 (152)	0.66	0.63	0.61	0.60	0.53	0.51	0.43	0.39	0.59	0.58	0.56	0.55	0.39	0.35	0.22	0.17	0.53	0.51	0.43	0.33	0.60	n/a	n/a	n/a	n/a
7 (178)	0.69	0.65	0.62	0.61	0.61	0.57	0.48	0.42	0.60	0.60	0.57	0.56	0.49	0.43	0.28	0.21	0.61	0.57	0.48	0.42	0.64	0.62	n/a	n/a	n/a
8 (203)	0.72	0.67	0.64	0.63	0.70	0.65	0.52	0.45	0.62	0.61	0.58	0.57	0.60	0.53	0.34	0.26	0.70	0.65	0.52	0.45	0.69	0.66	n/a	n/a	n/a
9 (229)	0.74	0.70	0.66	0.65	0.78	0.73	0.57	0.49	0.63	0.62	0.59	0.58	0.71	0.63	0.40	0.31	0.78	0.73	0.57	0.49	0.73	0.70	n/a	n/a	n/a
10 (254)	0.77	0.72	0.68	0.66	0.87	0.81	0.62	0.53	0.65	0.64	0.60	0.58	0.83	0.74	0.47	0.36	0.87	0.81	0.62	0.53	0.77	0.74	0.64	n/a	n/a
11 (279)	0.80	0.74	0.69	0.68	0.96	0.89	0.68	0.56	0.66	0.65	0.61	0.59	0.96	0.86	0.55	0.41	0.96	0.89	0.68	0.56	0.81	0.78	0.67	0.61	n/a
12 (305)	0.82	0.76	0.71	0.69	1.00	0.97	0.74	0.60	0.68	0.66	0.62	0.60	1.00	0.98	0.62	0.47	1.00	0.97	0.74	0.60	0.84	0.81	0.70	0.64	n/a
14 (356)	0.88	0.80	0.75	0.73	1.00	0.86	0.70	0.70	0.71	0.69	0.64	0.62	1.00	0.98	0.78	0.59	1.00	0.86	0.70	0.70	0.91	0.87	0.75	0.69	n/a
16 (406)	0.93	0.85	0.78	0.76		0.98	0.80	0.80	0.74	0.72	0.66	0.63			0.96	0.73		0.98	0.80	0.80	0.97	0.94	0.80	0.73	n/a
18 (457)	0.99	0.89	0.82	0.79		1.00	0.90	0.90	0.77	0.75	0.68	0.65			1.00	0.87		1.00	0.90	0.90	1.00	0.99	0.85	0.78	n/a
24 (610)	1.00	1.00	0.92	0.89			1.00	1.00	0.85	0.83	0.74	0.70			1.00				1.00	1.00	1.00	0.99	0.85	0.78	n/a
30 (762)			1.00	0.98					0.94	0.91	0.80	0.75											1.00	1.00	n/a
36 (914)				1.00					1.00	0.99	0.86	0.80													n/a
> 48 (1219)											0.99	0.90													n/a

Table 51 - Load adjustment factors for Hilti HIS-N and HIS-RN internally threaded inserts in cracked concrete^{1,2}

HIS-N and HIS-RN all diameters cracked concrete	Spacing factor in tension f_{AN}				Edge distance factor in tension f_{RN}				Spacing factor in shear ³ f_{AV}				Edge Distance in Shear								Concrete thickness factor in shear ⁴ f_{HV}				
													⊥ Toward edge f_{RV}				∥ To and away from edge f_{RV}								
	Internal diameter (mm)	3/8 (9.5)	1/2 (12.7)	5/8 (15.9)	3/4 (19.1)	3/8 (9.5)	1/2 (12.7)	5/8 (15.9)	3/4 (19.1)	3/8 (9.5)	1/2 (12.7)	5/8 (15.9)	3/4 (19.1)	3/8 (9.5)	1/2 (12.7)	5/8 (15.9)	3/4 (19.1)	3/8 (9.5)	1/2 (12.7)	5/8 (15.9)	3/4 (19.1)	3/8 (9.5)	1/2 (12.7)	5/8 (15.9)	3/4 (19.1)
Embedment h_{ef} (mm)	4-3/8 (111)	5 (127)	6-3/4 (171)	8-1/8 (206)	4-3/8 (111)	5 (127)	6-3/4 (171)	8-1/8 (206)	4-3/8 (111)	5 (127)	6-3/4 (171)	8-1/8 (206)	4-3/8 (111)	5 (127)	6-3/4 (171)	8-1/8 (206)	4-3/8 (111)	5 (127)	6-3/4 (171)	8-1/8 (206)	4-3/8 (111)	5 (127)	6-3/4 (171)	8-1/8 (206)	
3-1/4 (83)	0.59	n/a	n/a	n/a	0.54	n/a	n/a	n/a	0.55	n/a	n/a	n/a	0.16	n/a	n/a	n/a	0.31	n/a	n/a	n/a	n/a	n/a	n/a	n/a	n/a
4 (102)	0.61	0.59	n/a	n/a	0.59	0.54	n/a	n/a	0.56	0.55	n/a	n/a	0.22	0.19	n/a	n/a	0.42	0.38	n/a	n/a	n/a	n/a	n/a	n/a	n/a
5 (127)	0.64	0.61	0.59	n/a	0.66	0.60	0.54	n/a	0.57	0.57	0.55	n/a	0.30	0.26	0.17	n/a	0.59	0.53	0.34	n/a	n/a	n/a	n/a	n/a	
5-1/2 (140)	0.65	0.62	0.60	0.59	0.70	0.62	0.57	0.55	0.58	0.58	0.56	0.55	0.34	0.31	0.19	0.15	0.69	0.61	0.39	0.29	n/a	n/a	n/a	n/a	
6 (152)	0.66	0.63	0.61	0.60	0.74	0.65	0.59	0.57	0.59	0.58	0.56	0.55	0.39	0.35	0.22	0.17	0.74	0.65	0.44	0.34	0.80	n/a	n/a	n/a	
7 (178)	0.69	0.65	0.62	0.61	0.81	0.71	0.63	0.61	0.60	0.60	0.57	0.56	0.49	0.44	0.28	0.21	0.81	0.71	0.56	0.42	0.64	0.62	n/a	n/a	
8 (203)	0.72	0.67	0.64	0.63	0.89	0.77	0.68	0.65	0.62	0.61	0.58	0.57	0.69	0.54	0.34	0.26	0.89	0.77	0.68	0.52	0.69	0.66	n/a	n/a	
9 (229)	0.74	0.70	0.66	0.65	0.98	0.83	0.73	0.69	0.63	0.62	0.59	0.58	0.72	0.64	0.41	0.31	0.98	0.83	0.73	0.62	0.73	0.70	n/a	n/a	
10 (254)	0.77	0.72	0.68	0.66	1.00	0.90	0.78	0.73	0.65	0.64	0.60	0.58	0.84	0.75	0.45	0.36	1.00	0.90	0.78	0.72	0.77	0.74	0.64	n/a	
11 (279)	0.80	0.74	0.69	0.68	0.96	0.83	0.78	0.78	0.66	0.65	0.61	0.59	0.97	0.86	0.55	0.42	0.96	0.83	0.78	0.72	0.81	0.78	0.67	0.61	
12 (305)	0.82	0.76	0.71	0.69	1.00	0.88	0.83	0.83	0.68	0.66	0.62	0.60	1.00	0.98	0.63	0.48	1.00	0.88	0.83	0.84	0.84	0.81	0.70	0.64	
14 (356)	0.88	0.80	0.75	0.73		0.99	0.92	1.00	0.74	0.72	0.66	0.64			1.00	0.79	0.60		0.99	0.92	0.91	0.88	0.76	0.69	
16 (406)	0.93	0.85	0.78	0.76		1.00	1.00	1.00	0.74	0.72	0.66	0.64			0.97	0.73			1.00	1.00	0.97	0.94	0.81	0.74	
18 (457)	0.99	0.89	0.82	0.79					0.77	0.75	0.68	0.65			1.00	0.87					1.00	0.99	0.86	0.78	
24 (610)	1.00	1.00	0.92	0.89					0.86	0.83	0.74	0.70			1.00						1.00	0.99	0.85	0.78	
30 (762)			1.00	0.98					0.95	0.91	0.81	0.75											1.00	1.00	
36 (914)				1.00					1.00	0.99	0.87	0.80													
> 48 (1219)											1.00	0.99	0.91												

- 1 Linear interpolation not permitted.
- 2 When combining multiple load adjustment factors (e.g. for a 4 anchor pattern in a corner with a thin concrete member) the design can become very conservative. To optimize the design, use Hilti PROFIS Anchor Design software or perform anchor calculation using the design equations from ACI 318 Chapter 17.
- 3 Spacing factor reduction in shear applicable when $c < 3 \cdot h_{ef}$, f_{AV} is applicable when edge distance, $c < 3 \cdot h_{ef}$. If $c \geq 3 \cdot h_{ef}$, then $f_{AV} = f_{AN}$.
- 4 Concrete thickness reduction factor in shear, f_{HV} is applicable when edge distance, $c < 3 \cdot h_{ef}$. If $c \geq 3 \cdot h_{ef}$, then $f_{HV} = 1.0$.

DESIGN DATA IN CONCRETE PER CSA A23.3

CSA A23.3-14 Annex D design

Limit State Design of anchors is described in the provisions of CSA A23.3-14 Annex D for post-installed anchors tested and assessed in accordance with ACI 355.2 for mechanical anchors and ACI 355.4 for adhesive anchors. This section contains the Limit State Design tables with unfactored characteristic loads that are based on the published loads in ICC Evaluation Services ESR-3814 and ELC-3814. These tables are followed by factored resistance tables. The factored resistance tables have characteristic design loads that are prefactored by the applicable reduction factors for a single anchor with no anchor-to-anchor spacing or edge distance adjustments for the convenience of the user of this document. All the figures in the previous ACI 318-14 Chapter 17 design section are applicable to Limit State Design and the tables will reference these figures.

For a detailed explanation of the tables developed in accordance with CSA A23.3-14 Annex D, refer to Section 3.1.8. Technical assistance is available by contacting Hilti Canada at (800) 363-4458 or at www.hilti.com.

HIT-RE 500 V3 adhesive with Deformed Reinforcing Bars (Rebar)



Table 52 - Specifications for CA rebar installed with Hilti HIT-RE 500 V3



Setting information		Symbol	Units	Rebar size				
				10M	15M	20M	25M	30M
Nominal bit diameter		d_o	in.	9/16	3/4	1	1-1/4	1-1/2
Effective embedment	minimum	$h_{ef,min}$	mm	60	80	90	100	120
	maximum	$h_{ef,max}$	mm	226	320	390	504	598
Minimum concrete member thickness		h_{min}	mm	$h_{ef} + 30$	$h_{ef} + 2d_o$			

Note: The installation specifications in table 52 above and the data in tables 53 through 67 pertain to the use of Hilti HIT-RE 500 V3 with rebar designed as a post-installed anchor using the provisions of CSA A23.3-14 Annex D. For the use of Hilti HIT-RE 500 V3 with rebar for typical development calculations according to CSA A23.3-14 Chapter 12, refer to section 3.1.8 for the design method and tables 88 through 92 in section 3.2.4.

Table 53 - Steel factored resistance for CA rebar¹



Rebar size	CSA-G30.18 Grade 400 ²		
	Tensile ³ N_{sar} lb (kN)	Shear ⁴ V_{sar} lb (kN)	Seismic shear ⁵ $V_{sar,eq}$ lb (kN)
10M	7,245 (32.2)	4,035 (17.9)	2,825 (12.6)
15M	14,525 (64.6)	8,090 (36.0)	5,665 (25.2)
20M	21,570 (95.9)	12,020 (53.5)	8,415 (37.4)
25M	36,025 (160.2)	20,070 (89.3)	14,050 (62.5)
30M	50,715 (225.6)	28,255 (125.7)	19,780 (88.0)

- See Section 3.1.8 to convert design strength value to ASD value.
- CSA-G30.18 Grade 400 rebar are considered ductile steel elements.
- Tensile = $A_{se,N} \phi_s f_{uta}$, R as noted in CSA A23.3-14 Annex D
- Shear = $A_{se,V} \phi_s 0.60 f_{uta}$, R as noted in CSA A23.3-14 Annex D.
- Seismic Shear = $\alpha_{seis} V_{sar}$; Reduction factor for seismic shear only. See section 3.1.8 for additional information on seismic applications.

Table 54 - Hilti HIT-RE 500 V3 adhesive design information with CA rebar in hammer drilled holes in accordance with CSA A23.3-14 Annex D^{1,8}

Design parameter	Symbol	Units	Rebar size					Ref A23.3-14	
			10M	15M	20M	25M	30M		
Anchor O.D.	d_a	-	11.3	16.0	19.5	25.2	29.9		
Effective minimum embedment ²	h_{ef}	-	60	80	90	101	120		
Effective maximum embedment ²	h_{ef}	-	226	320	390	504	598		
Min. concrete thickness ²	h_{min}	-	$h_{ef} + 30$	$h_{ef} + 2d_o$					
Critical edge distance	c_{ed}	-	$2h_{ef}$						
Minimum edge distance	c_{min}^3	-	57	80	98	126	150		
Minimum anchor spacing	s_{min}	-	57	80	98	126	150		
Coeff. for factored conc. breakout resistance, uncracked concrete	$k_{c,un-cr}^4$	-	10					D.6.2.2	
Coeff. for factored conc. breakout resistance, cracked concrete	$k_{c,cr}^4$	-	7					D.6.2.2	
Concrete material resistance factor	ϕ_c	-	0.65					8.4.2	
Resistance modification factor for tension and shear, concrete failure modes, Condition B ⁵	R_{conc}	-	1.00					D.5.3(c)	
Dry concrete and water saturated									
Temp. range A ⁶	Characteristic bond stress in cracked concrete ^{7,8}	τ_{cr}	psi (MPa)	1,360 (9.4)	1,390 (9.6)	1,410 (9.7)	1,420 (9.8)	1,380 (9.5)	D.6.5.2
	Characteristic bond stress in uncracked concrete ^{7,8}	τ_{un-cr}	psi (MPa)	1,760 (12.1)	1,720 (11.9)	1,690 (11.7)	1,650 (11.4)	1,610 (11.1)	D.6.5.2
Temp. range B ⁶	Characteristic bond stress in cracked concrete ^{7,8}	τ_{cr}	psi (MPa)	940 (6.5)	960 (6.6)	970 (6.7)	980 (6.8)	950 (6.6)	D.6.5.2
	Characteristic bond stress in uncracked concrete ^{7,8}	τ_{un-cr}	psi (MPa)	1,210 (8.3)	1,190 (8.2)	1,170 (8.1)	1,140 (7.9)	1,110 (7.7)	D.6.5.2
Anchor category, dry concrete		-	-	1	1	1	1	1	D.5.3(c)
Resistance modification factor		R_{dry}	-	1.00	1.00	1.00	1.00	1.00	
Water-filled hole									
Temp. range A ⁶	Characteristic bond stress in cracked concrete ^{7,8}	τ_{cr}	psi (MPa)	1,010 (7.0)	1,040 (7.2)	1,060 (7.3)	1,080 (7.4)	1,060 (7.3)	D.6.5.2
	Characteristic bond stress in uncracked concrete ^{7,8}	τ_{un-cr}	psi (MPa)	1,300 (9.0)	1,280 (8.8)	1,270 (8.8)	1,250 (8.6)	1,240 (8.6)	D.6.5.2
Temp. range B ⁶	Characteristic bond stress in cracked concrete ^{7,8}	τ_{cr}	psi (MPa)	700 (4.8)	720 (5.0)	730 (5.0)	740 (5.1)	730 (5.0)	D.6.5.2
	Characteristic bond stress in uncracked concrete ^{7,8}	τ_{un-cr}	psi (MPa)	900 (6.2)	890 (6.1)	880 (6.1)	860 (5.9)	850 (5.9)	D.6.5.2
Anchor category, water-filled hole		-	-	3	3	3	3	3	D.5.3(c)
Resistance modification factor		R_{wf}	-	0.75	0.75	0.75	0.75	0.75	
Underwater application									
Temp. range A ⁶	Characteristic bond stress in cracked concrete ^{7,8}	τ_{cr}	psi (MPa)	880 (6.1)	920 (6.3)	940 (6.5)	980 (6.8)	960 (6.6)	D.6.5.2
	Characteristic bond stress in uncracked concrete ^{7,8}	τ_{un-cr}	psi (MPa)	1,130 (7.8)	1,140 (7.9)	1,140 (7.9)	1,140 (7.9)	1,130 (7.8)	D.6.5.2
Temp. range B ⁶	Characteristic bond stress in cracked concrete ^{7,8}	τ_{cr}	psi (MPa)	610 (4.2)	630 (4.3)	650 (4.5)	680 (4.7)	660 (4.6)	D.6.5.2
	Characteristic bond stress in uncracked concrete ^{7,8}	τ_{un-cr}	psi (MPa)	780 (5.4)	790 (5.4)	780 (5.4)	780 (5.4)	780 (5.4)	D.6.5.2
Anchor category, underwater		-	-	3	3	3	3	3	D.5.3(c)
Resistance modification factor		R_{uw}	-	0.75	0.75	0.75	0.75	0.75	
Resistance for seismic tension		$\alpha_{N,seis}$	-	0.90	0.90	0.90	0.90	0.90	

1 Design information in this table is taken from ICC-ES ELC-3814, dated April 2018,, table 23 and 24, and converted for use with CSA A23.3-14 Annex D.

2 See figure 2 of section 3.2.4.3.1.

3 Minimum edge distance may be reduced to 45mm provided rebar remains untorqued. See ESR-3814 section 4.1.9.

4 For all design cases, $\psi_{c,N} = 1.0$. The appropriate coefficient for breakout resistance for cracked concrete ($k_{c,cr}$) or uncracked concrete ($k_{c,un-cr}$) must be used.

5 For use with the load combinations of CSA A23.3-14 chapter 8. Condition B applies where supplementary reinforcement in conformance with CSA A23.3-14 section D.5.3 is not provided, or where pullout or pryout strength governs. For cases where the presence of supplementary reinforcement can be verified, the resistance modification factors associated with Condition A may be used.

6 Temperature range A: Max. short term temperature = 130°F (55°C), max. long term temperature = 110°F (43°C).

Temperature range B: Max. short term temperature = 176°F (80°C), max. long term temperature = 110°F (43°C).

Short term elevated concrete temperatures are those that occur over brief intervals, e.g., as a result of diurnal cycling. Long term concrete temperatures are roughly constant over significant periods of time.

7 Bond stress values corresponding to concrete compressive stress $f'_c = 2,500$ psi (17.2 MPa). For concrete compressive strength, f'_c between 2,500 psi (17.2 MPa) and 8,000 psi (55.2 MPa), the tabulated characteristic bond stress may be increased by a factor of $(f'_c / 2,500)^{0.25}$ [for SI: $(f'_c / 17.2)^{0.25}$] for uncracked concrete and $(f'_c / 2,500)^{0.15}$ [for SI: $(f'_c / 17.2)^{0.15}$] for cracked concrete.

8 For structures assigned to Seismic Design Categories C, D, E, or F, bond stress values must be multiplied by $\alpha_{N,seis}$.



Table 55 - Hilti HIT-RE 500 V3 adhesive design information with CA rebar in diamond core drilled holes in accordance with CSA A23.3-14 Annex D¹

Design parameter	Symbol	Units	Rebar size					Ref	
			10M	15M	20M	25M	30M		
Anchor O.D.	d_a	-	11.3	16.0	19.5	25.2	29.9		
Effective minimum embedment ²	h_{ef}	-	60	80	90	101	120		
Effective maximum embedment ²	h_{ef}	-	226	320	390	504	598		
Min. concrete thickness ²	h_{min}	-	$h_{ef} + 30$	$h_{ef} + 2d_b$					
Critical edge distance	c_{ac}	-	$2h_{ef}$						
Minimum edge distance	c_{min}^3	-	57	80	98	126	150		
Minimum anchor spacing	s_{min}	-	57	80	98	126	150		
Coeff. for factored conc. breakout resistance, uncracked concrete	$k_{c,uncr}^4$	-	10					D.6.2.2	
Coeff. for factored conc. breakout resistance, cracked concrete	$k_{c,cr}^4$	-	7					D.6.2.2	
Concrete material resistance factor	ϕ_c	-	0.65					8.4.2	
Resistance modification factor for tension and shear, concrete failure modes, Condition B ⁵	R_{conc}	-	1.00					D.5.3(c)	
Dry concrete and water saturated concrete									
Temp. range A	Characteristic bond stress in cracked concrete ^{7,8}	τ_{uncr}	psi	1,150	1,150	1,150	1,150	1,150	D.6.5.2
			(MPa)	(7.9)	(7.9)	(7.9)	(7.9)	(7.9)	
Temp. range B	Characteristic bond stress in uncracked concrete ^{7,8}	τ_{uncr}	psi	800	800	800	800	800	D.6.5.2
			(MPa)	(5.5)	(5.5)	(5.5)	(5.5)	(5.5)	
Anchor category, dry concrete		-	-	2	3	3	3	3	D.5.3(c)
Resistance modification factor		R_{dry}	-	0.85	0.75	0.75	0.75	0.75	

1 Design information in this table is taken from ELC-3814, dated April 2018, table 23 and 25B, and converted for use with CSA A23.3-14 Annex D.

2 See figure 2 of section 3.2.4.3.1.

3 Minimum edge distance may be reduced to 45mm provided rebar remains untorqued. See ESR-3814 section 4.1.9.

4 For all design cases, $\psi_{c,N} = 1.0$. The appropriate coefficient for breakout resistance for cracked concrete ($k_{c,cr}$) or uncracked concrete ($k_{c,uncr}$) must be used.

5 For use with the load combinations of CSA A23.3-14 chapter 8. Condition B applies where supplementary reinforcement in conformance with CSA A23.3-14 section D.5.3 is not provided, or where pullout or pryout strength governs. For cases where the presence of supplementary reinforcement can be verified, the resistance modification factors associated with Condition A may be used.

6 Temperature range A: Max. short term temperature = 130°F (55°C), max. long term temperature = 110°F (43°C).

Temperature range B: Max. short term temperature = 176°F (80°C), max. long term temperature = 110°F (43°C).

Short term elevated concrete temperatures are those that occur over brief intervals, e.g., as a result of diurnal cycling. Long term concrete temperatures are roughly constant over significant periods of time.

7 Bond stress values correspond to concrete compressive strength $f'_c = 2,500$ psi (17.2 MPa). For concrete compressive strength, f'_c , between 2,500 psi (17.2 MPa) and 8,000 psi (55.2 MPa), the tabulated characteristic bond stress may be increased by a factor of $(f'_c/2,500)^{0.25}$ [for SI: $(f'_c/17.2)^{0.25}$] for uncracked concrete.

3.2.3

Table 56 - Hilti HIT-RE 500 V3 adhesive factored resistance with concrete/bond failure for CA rebar in uncracked concrete^{1,2,3,4,5,6,7,8,9,10,11}



Rebar size	Effective embedment in. (mm)	Tension N_t				Shear V_r			
		$f'_c = 20$ MPa (2,900 psi) lb (kN)	$f'_c = 25$ MPa (3,625 psi) lb (kN)	$f'_c = 30$ MPa (4,350 psi) lb (kN)	$f'_c = 40$ MPa (5,800 psi) lb (kN)	$f'_c = 20$ MPa (2,900 psi) lb (kN)	$f'_c = 25$ MPa (3,625 psi) lb (kN)	$f'_c = 30$ MPa (4,350 psi) lb (kN)	$f'_c = 40$ MPa (5,800 psi) lb (kN)
10M	4-1/2 (115)	7,520 (33.4)	7,950 (35.4)	8,320 (37.0)	8,940 (39.8)	15,040 (66.9)	15,900 (70.7)	16,645 (74.0)	17,885 (79.6)
	7-1/16 (180)	11,770 (52.4)	12,445 (55.4)	13,025 (57.9)	13,995 (62.3)	23,540 (104.7)	24,890 (110.7)	26,050 (115.9)	27,990 (124.5)
	8-7/8 (226)	14,775 (65.7)	15,625 (69.5)	16,355 (72.7)	17,575 (78.2)	29,555 (131.5)	31,250 (139.0)	32,705 (145.5)	35,145 (156.3)
15M ¹⁰	5-11/16 (145)	11,410 (50.8)	12,755 (56.7)	13,975 (62.2)	15,600 (69.4)	22,820 (101.5)	25,515 (113.5)	27,950 (124.3)	31,205 (138.8)
	9-13/16 (250)	22,620 (100.6)	23,915 (106.4)	25,030 (111.3)	26,900 (119.7)	45,240 (201.2)	47,835 (212.8)	50,065 (222.7)	53,800 (239.3)
	12-5/8 (320)	28,950 (128.8)	30,615 (136.2)	32,040 (142.5)	34,430 (153.2)	57,905 (257.6)	61,225 (272.3)	64,080 (285.1)	68,860 (306.3)
20M ¹⁰	7-7/8 (200)	18,485 (82.2)	20,665 (91.9)	22,640 (100.7)	25,770 (114.6)	36,965 (164.4)	41,330 (183.8)	45,275 (201.4)	51,540 (229.3)
	14 (355)	38,460 (171.1)	40,670 (180.9)	42,565 (189.3)	45,740 (203.5)	76,925 (342.2)	81,340 (361.8)	85,130 (378.7)	91,480 (406.9)
	15-3/8 (390)	42,255 (188.0)	44,680 (198.7)	46,760 (208.0)	50,250 (223.5)	84,510 (375.9)	89,355 (397.5)	93,525 (416.0)	100,500 (447.0)
25M	9-1/16 (230)	22,795 (101.4)	25,485 (113.4)	27,920 (124.2)	32,235 (143.4)	45,590 (202.8)	50,970 (226.7)	55,835 (248.4)	64,475 (286.8)
	15-15/16 (405)	53,265 (236.9)	58,540 (260.4)	61,270 (272.5)	65,840 (292.9)	106,525 (473.9)	117,080 (520.8)	122,540 (545.1)	131,680 (585.7)
	19-13/16 (504)	68,895 (306.5)	72,850 (324.1)	76,245 (339.2)	81,935 (364.5)	137,795 (612.9)	145,700 (648.1)	152,495 (678.3)	163,865 (728.9)
30M	10-1/4 (260)	27,395 (121.9)	30,630 (136.3)	33,555 (149.3)	38,745 (172.3)	54,795 (243.7)	61,260 (272.5)	67,110 (298.5)	77,490 (344.7)
	17-15/16 (455)	63,425 (282.1)	70,910 (315.4)	77,680 (345.5)	85,635 (380.9)	126,850 (564.3)	141,825 (630.9)	155,360 (691.1)	171,270 (761.8)
	23-9/16 (598)	94,640 (421.0)	100,070 (445.1)	104,740 (465.9)	112,550 (500.6)	189,285 (842.0)	200,145 (890.3)	209,475 (931.8)	225,100 (1001.3)

- 1 See Section 3.1.8 for explanation on development of load values.
- 2 See Section 3.1.8 to convert design strength value to ASD value.
- 3 Linear interpolation between embedment depths and concrete compressive strengths is not permitted.
- 4 Apply spacing, edge distance, and concrete thickness factors in tables 61-70 as necessary to the above values. Compare to the steel values in table 53. The lesser of the values is to be used for the design.
- 5 Data is for temperature range A: Max. short term temperature = 130°F (55°C), max. long term temperature = 110°F (43°C).
For temperature range B: Max. short term temperature = 176°F (80°C), max. long term temperature = 110°F (43°C) multiply above values by 0.69.
Short term elevated concrete temperatures are those that occur over brief intervals, e.g., as a result of diurnal cycling. Long term concrete temperatures are roughly constant over significant periods of time.
- 6 Tabular values are for dry concrete and water-saturated concrete conditions.
For water-filled drilled holes multiply design strength by 0.51.
For submerged (under water) applications multiply design strength by 0.45.
- 7 Tabular values are for short term loads only. For sustained loads including overhead use, see Section 3.1.8.
- 8 Tabular values are for normal-weight concrete only. For lightweight concrete multiply design strength by λ_a as follows:
For sand-lightweight, $\lambda_a = 0.51$. For all-lightweight, $\lambda_a = 0.45$.
- 9 Tabular values are for holes drilled in concrete with carbide tipped hammer drill bit. For diamond core drilling, except as indicated in note 10, multiply above values by 0.48.
Diamond core drilling is not permitted for the water-filled or under-water (submerged) applications.
- 10 Diamond core drilling with Hilti TE-YRT roughening tool is permitted for 15M and 20M diameter anchors for dry and water-saturated concrete conditions. See Table 59.
- 11 Tabular values are for static loads only. Seismic design is not permitted for uncracked concrete.



Table 57 - Hilti HIT-RE 500 V3 adhesive factored resistance with concrete/bond failure for CA rebar in cracked concrete^{1,2,3,4,5,6,7,8,9,10}

Rebar size	Effective embedment in. (mm)	Tension N_t				Shear V_r			
		$f'_c = 20$ MPa (2,900 psi) lb (kN)	$f'_c = 25$ MPa (3,625 psi) lb (kN)	$f'_c = 30$ MPa (4,350 psi) lb (kN)	$f'_c = 40$ MPa (5,800 psi) lb (kN)	$f'_c = 20$ MPa (2,900 psi) lb (kN)	$f'_c = 25$ MPa (3,625 psi) lb (kN)	$f'_c = 30$ MPa (4,350 psi) lb (kN)	$f'_c = 40$ MPa (5,800 psi) lb (kN)
10M	4-1/2 (115)	5,640 (25.1)	5,920 (26.3)	6,080 (27.1)	6,350 (28.2)	11,285 (50.2)	11,835 (52.7)	12,165 (54.1)	12,700 (56.5)
	7-1/16 (180)	8,960 (39.8)	9,265 (41.2)	9,520 (42.3)	9,940 (44.2)	17,915 (79.7)	18,525 (82.4)	19,040 (84.7)	19,880 (88.4)
	8-7/8 (226)	11,250 (50.0)	11,630 (51.7)	11,955 (53.2)	12,480 (55.5)	22,495 (100.1)	23,260 (103.5)	23,905 (106.3)	24,960 (111.0)
15M ¹⁰	5-11/16 (145)	7,985 (35.5)	8,930 (39.7)	9,780 (43.5)	11,295 (50.2)	15,975 (71.1)	17,860 (79.4)	19,565 (87.0)	22,590 (100.5)
	9-13/16 (250)	18,005 (80.1)	18,620 (82.8)	19,135 (85.1)	19,980 (88.9)	36,010 (160.2)	37,235 (165.6)	38,270 (170.2)	39,955 (177.7)
	12-5/8 (320)	23,045 (102.5)	23,830 (106.0)	24,495 (108.9)	25,575 (113.8)	46,095 (205.0)	47,665 (212.0)	48,985 (217.9)	51,145 (227.5)
20M ¹⁰	7-7/8 (200)	12,940 (57.6)	14,465 (64.3)	15,845 (70.5)	18,300 (81.4)	25,875 (115.1)	28,930 (128.7)	31,695 (141.0)	36,595 (162.8)
	14 (355)	30,595 (136.1)	32,685 (145.4)	33,590 (149.4)	35,075 (156.0)	61,195 (272.2)	65,370 (290.8)	67,185 (298.8)	70,145 (312.0)
	15-3/8 (390)	34,725 (154.5)	35,910 (159.7)	36,905 (164.2)	38,530 (171.4)	69,450 (308.9)	71,815 (319.5)	73,805 (328.3)	77,060 (342.8)
25M	9-1/16 (230)	15,955 (71.0)	17,840 (79.4)	19,540 (86.9)	22,565 (100.4)	31,915 (142.0)	35,680 (158.7)	39,085 (173.9)	45,130 (200.8)
	15-15/16 (405)	37,285 (165.8)	41,685 (185.4)	45,665 (203.1)	52,075 (231.6)	74,570 (331.7)	83,370 (370.8)	91,325 (406.2)	104,150 (463.3)
	19-13/16 (504)	51,760 (230.2)	57,870 (257.4)	62,070 (276.1)	64,805 (288.3)	103,520 (460.5)	115,735 (514.8)	124,135 (552.2)	129,610 (576.5)
30M	10-1/4 (260)	19,180 (85.3)	21,440 (95.4)	23,490 (104.5)	27,120 (120.6)	38,355 (170.6)	42,885 (190.8)	46,975 (209.0)	54,245 (241.3)
	17-15/16 (455)	44,400 (197.5)	49,640 (220.8)	54,375 (241.9)	62,790 (279.3)	88,795 (395.0)	99,275 (441.6)	108,750 (483.7)	125,575 (558.6)
	23-9/16 (598)	66,895 (297.6)	74,790 (332.7)	81,930 (364.4)	88,665 (394.4)	133,790 (595.1)	149,580 (665.4)	163,860 (728.9)	177,325 (788.8)

3.2.3

- See Section 3.1.8 for explanation on development of load values.
- See Section 3.1.8 to convert design strength value to ASD value.
- Linear interpolation between embedment depths and concrete compressive strengths is not permitted.
- Apply spacing, edge distance, and concrete thickness factors in tables 61-70 as necessary to the above values. Compare to the steel values in table 53. The lesser of the values is to be used for the design.
- Data is for temperature range A: Max. short term temperature = 130°F (55°C), max. long term temperature = 110°F (43°C).
For temperature range B: Max. short term temperature = 176°F (80°C), max. long term temperature = 110°F (43°C) multiply above values by 0.69.
Short term elevated concrete temperatures are those that occur over brief intervals, e.g., as a result of diurnal cycling. Long term concrete temperatures are roughly constant over significant periods of time.
- Tabular values are for dry concrete and water-saturated concrete conditions.
For water-filled drilled holes multiply design strength by 0.51.
For submerged (under water) applications multiply design strength by 0.45.
- Tabular values are for short term loads only. For sustained loads including overhead use, see Section 3.1.8.
- Tabular values are for normal-weight concrete only. For lightweight concrete multiply design strength by λ_a as follows:
For sand-lightweight, $\lambda_a = 0.51$. For all-lightweight, $\lambda_a = 0.45$.
- Tabular values are for holes drilled in concrete with carbide tipped hammer drill bit. Diamond core drilling is not permitted in cracked concrete conditions except as indicated in note 10.
- Diamond core drilling with Hilti TE-YRT roughening tool is permitted for 15M and 20M diameter anchors for dry and water-saturated concrete conditions. See Table 60.
- Tabular values are for static loads only. For seismic loads, multiply cracked concrete tabular values by $\alpha_{seis} = 0.68$. See section 3.1.8 for additional information on seismic applications.

Table 58 - Hilti HIT-RE 500 V3 adhesive design information with CA rebar in core drilled holes roughened with the TE-YRT Roughening Tool in accordance with CSA A23.3-14 Annex D^{1,9}

Design parameter	Symbol	Units	Rebar size		Ref A23.3-14	
			15M	20M		
Anchor O.D.	d_a	-	16.0	19.5		
Effective minimum embedment ²	h_{ef}	-	80	90		
Effective maximum embedment ²	h_{ef}	-	320	390		
Min. concrete thickness ²	h_{min}	-	$2h_{ef}$			
Critical edge distance	c_{ac}	-	$h_{ef} + 2d_0$			
Minimum edge distance	c_{min}^3	-	80	98		
Minimum anchor spacing	s_{min}	-	80	98		
Coeff. for factored conc. breakout resistance, uncracked concrete	$k_{c,uncr}^4$	-	10		D.6.2.2	
Coeff. for factored conc. breakout resistance, cracked concrete	$k_{c,cr}^4$	-	7		D.6.2.2	
Concrete material resistance factor	ϕ_c	-	0.65		8.4.2	
Resistance modification factor for tension and shear, concrete failure modes, Condition B ⁵	R_{conc}	-	1.00		D.5.3 (c)	
Dry concrete and water saturated concrete						
Temp. range A ⁶	Characteristic bond stress in cracked concrete ^{6,7}	T_{cr}	psi (MPa)	970 (6.7)	985 (6.8)	D.6.5.2
	Characteristic bond stress in uncracked concrete ^{6,7}	T_{uncr}	psi (MPa)	1,720 (11.9)	1,690 (11.7)	D.6.5.2
Temp. range B ⁶	Characteristic bond stress in cracked concrete ^{6,7}	T_{cr}	psi (MPa)	670 (4.6)	680 (4.7)	D.6.5.2
	Characteristic bond stress in uncracked concrete ^{6,7}	T_{uncr}	psi (MPa)	1,190 (8.2)	1,170 (8.1)	D.6.5.2
Anchor category, dry concrete		-	-	1	1	D.5.3(c)
Resistance modification factor		R_{dry}	-	1.00	1.00	
Reduction for Seismic Tension		$\alpha_{N,seis}$	-	0.90	0.90	

1 Design information in this table is taken from ICC-ES ELC-3814, dated April 2018, table 23 and 25A, and converted for use with CSA A23.3-14 Annex D.

2 See figure 2 of section 3.2.4.3.4.

3 Minimum edge distance may be reduced to 45mm provided rebar remains untorqued. See ESR-3814 section 4.1.9.

4 For all design cases, $\psi_c N = 1.0$. The appropriate coefficient for breakout resistance for cracked concrete ($k_{c,cr}$) or uncracked concrete ($k_{c,uncr}$) must be used.

5 For use with the load combinations of CSA A23.3-14 chapter 8. Condition B applies where supplementary reinforcement in conformance with CSA A23.3-14 section D.5.3 is not provided, or where pullout or pryout strength governs. For cases where the presence of supplementary reinforcement can be verified, the resistance modification factors associated with Condition A may be used.

6 Temperature range A: Max. short term temperature = 130°F (55°C), max. long term temperature = 110°F (43°C). Temperature range B: Max. short term temperature = 176°F (80°C), max. long term temperature = 110°F (43°C). Short term elevated concrete temperatures are those that occur over brief intervals, e.g., as a result of diurnal cycling. Long term concrete temperatures are roughly constant over significant periods of time.

7 Bond stress values correspond to concrete compressive strength in the range 2,500 psi ≤ f'_c ≤ 8,000 psi.

8 For structures assigned to Seismic Design Categories C, D, E, or F, bond stress values must be multiplied by $\alpha_{N,seis}$.



Table 59 - Hilti HIT-RE 500 V3 adhesive factored resistance for core drilled holes roughened with Hilti TE-YRT roughening tool with concrete / bond failure for CA rebar in uncracked concrete^{1,2,3,4,5,6,7,8,9}

Rebar size	Effective embedment in. (mm)	Tension - N_r				Shear - V_r			
		$f'_c = 20$ MPa (2,900psi) lb (kN)	$f'_c = 25$ MPa (3,625 psi) lb (kN)	$f'_c = 30$ MPa (4,350 psi) lb (kN)	$f'_c = 40$ MPa (5,800 psi) lb (kN)	$f'_c = 20$ MPa (2,900 psi) lb (kN)	$f'_c = 25$ MPa (3,625 psi) lb (kN)	$f'_c = 30$ MPa (4,350 psi) lb (kN)	$f'_c = 40$ MPa (5,800 psi) lb (kN)
15M	5-11/16 (145)	11,410 (50.8)	12,635 (56.2)	12,635 (56.2)	12,635 (56.2)	22,820 (101.5)	25,265 (112.4)	25,265 (112.4)	25,265 (112.4)
	9-13/16 (250)	21,780 (96.9)	21,780 (96.9)	21,780 (96.9)	21,780 (96.9)	43,565 (193.8)	43,565 (193.8)	43,565 (193.8)	43,565 (193.8)
	12-5/8 (320)	27,880 (124.0)	27,880 (124.0)	27,880 (124.0)	27,880 (124.0)	55,760 (248.0)	55,760 (248.0)	55,760 (248.0)	55,760 (248.0)
20M	7-7/8 (200)	18,485 (82.2)	20,665 (91.9)	20,865 (92.8)	20,865 (92.8)	36,965 (164.4)	41,330 (183.8)	41,735 (185.6)	41,735 (185.6)
	14 (355)	37,040 (164.8)	37,040 (164.8)	37,040 (164.8)	37,040 (164.8)	74,080 (329.5)	74,080 (329.5)	74,080 (329.5)	74,080 (329.5)
	15-3/8 (390)	40,690 (181.0)	40,690 (181.0)	40,690 (181.0)	40,690 (181.0)	81,380 (362.0)	81,380 (362.0)	81,380 (362.0)	81,380 (362.0)

- See Section 3.1.8 for explanation on development of load values.
- See Section 3.1.8 to convert design strength value to ASD value.
- Linear interpolation between embedment depths and concrete compressive strengths is not permitted.
- Apply spacing, edge distance, and concrete thickness factors in tables 61-70 as necessary to the above values. Compare to the steel values in table 53. The lesser of the values is to be used for the design.
- Data is for temperature range A: Max. short term temperature = 130°F (55°C), max. long term temperature = 110°F (43°C). For temperature range B: Max. short term temperature = 176°F (80°C), max. long term temperature = 110°F (43°C) multiply above values by 0.69. Short term elevated concrete temperatures are those that occur over brief intervals, e.g., as a result of diurnal cycling. Long term concrete temperatures are roughly constant over significant periods of time.
- Tabular values are for dry concrete or water-saturated concrete conditions. Water-filled and submerged (under water) applications are not permitted for this hole preparation method.
- Tabular values are for short term loads only. For sustained loads including overhead use, see Section 3.1.8.
- Tabular values are for normal-weight concrete only. For lightweight concrete multiply design strength by λ_a as follows: For sand-lightweight, $\lambda_a = 0.51$. For all lightweight, $\lambda_a = 0.45$.
- Tabular values are for static loads only. Seismic design is not permitted for uncracked concrete.

3.2.3

Table 60 - Hilti HIT-RE 500 V3 adhesive factored resistance for core drilled holes roughened with Hilti TE-YRT roughening tool with concrete / bond failure for CA rebar in cracked concrete^{1,2,3,4,5,6,7,8,9}



Rebar size	Effective embedment in. (mm)	Tension - N_r				Shear - V_r			
		$f'_c = 20$ MPa (2,900psi) lb (kN)	$f'_c = 25$ MPa (3,625 psi) lb (kN)	$f'_c = 30$ MPa (4,350 psi) lb (kN)	$f'_c = 40$ MPa (5,800 psi) lb (kN)	$f'_c = 20$ MPa (2,900 psi) lb (kN)	$f'_c = 25$ MPa (3,625 psi) lb (kN)	$f'_c = 30$ MPa (4,350 psi) lb (kN)	$f'_c = 40$ MPa (5,800 psi) lb (kN)
15M	5-11/16 (145)	7,125 (31.7)	7,125 (31.7)	7,125 (31.7)	7,125 (31.7)	14,250 (63.4)	14,250 (63.4)	14,250 (63.4)	14,250 (63.4)
	9-13/16 (250)	12,285 (54.6)	12,285 (54.6)	12,285 (54.6)	12,285 (54.6)	24,570 (109.3)	24,570 (109.3)	24,570 (109.3)	24,570 (109.3)
	12-5/8 (320)	15,725 (69.9)	15,725 (69.9)	15,725 (69.9)	15,725 (69.9)	31,445 (139.9)	31,445 (139.9)	31,445 (139.9)	31,445 (139.9)
20M	7-7/8 (200)	12,160 (54.1)	12,160 (54.1)	12,160 (54.1)	12,160 (54.1)	24,325 (108.2)	24,325 (108.2)	24,325 (108.2)	24,325 (108.2)
	14 (355)	21,590 (96.0)	21,590 (96.0)	21,590 (96.0)	21,590 (96.0)	43,175 (192.1)	43,175 (192.1)	43,175 (192.1)	43,175 (192.1)
	15-3/8 (390)	23,715 (105.5)	23,715 (105.5)	23,715 (105.5)	23,715 (105.5)	47,435 (211.0)	47,435 (211.0)	47,435 (211.0)	47,435 (211.0)

- See Section 3.1.8 for explanation on development of load values.
- See Section 3.1.8 to convert design strength value to ASD value.
- Linear interpolation between embedment depths and concrete compressive strengths is not permitted.
- Apply spacing, edge distance, and concrete thickness factors in tables 61-70 as necessary to the above values. Compare to the steel values in table 53. The lesser of the values is to be used for the design.
- Data is for temperature range A: Max. short term temperature = 130°F (55°C), max. long term temperature = 110°F (43°C). For temperature range B: Max. short term temperature = 176°F (80°C), max. long term temperature = 110°F (43°C) multiply above values by 0.69. Short term elevated concrete temperatures are those that occur over brief intervals, e.g., as a result of diurnal cycling. Long term concrete temperatures are roughly constant over significant periods of time.
- Tabular values are for dry concrete or water-saturated concrete conditions. Water-filled and submerged (under water) applications are not permitted for this hole preparation method. Tabular values are for short term loads only. For sustained loads including overhead use, see Section 3.1.8.
- Tabular values are for normal-weight concrete only. For lightweight concrete multiply design strength by λ_a as follows: For sand-lightweight, $\lambda_a = 0.51$. For all-lightweight, $\lambda_a = 0.45$.
- Tabular values are for static loads only. For seismic loads, multiply cracked concrete tabular values by $\alpha_{seis} = 0.675$. See section 3.1.8 for additional information on seismic applications.

Table 61 - Load adjustment factors for 10M rebar in uncracked concrete^{1,2,3}

10M uncracked concrete	Spacing factor in tension f_{AN}			Edge distance factor in tension f_{RN}			Spacing factor in shear ⁴ f_{AV}			Edge distance in shear						Concrete thickness factor in shear ⁵ f_{HV}		
										⊥ Toward edge f_{RV}			∥ To and away from edge f_{RV}					
	Embedment h_{ef} in. (mm)	4-1/2 (115)	7-1/16 (180)	8-7/8 (226)	4-1/2 (115)	7-1/16 (180)	8-7/8 (226)	4-1/2 (115)	7-1/16 (180)	8-8/9 (226)	4-1/2 (115)	7-1/16 (180)	8-7/8 (226)	4-1/2 (115)	7-1/16 (180)	8-7/8 (226)	4-1/2 (115)	7-1/16 (180)
1-3/4 (44)	n/a	n/a	n/a	0.24	0.15	0.12	n/a	n/a	n/a	0.06	0.04	0.03	0.11	0.07	0.06	n/a	n/a	n/a
2-3/16 (55)	0.58	0.55	0.54	0.26	0.16	0.13	0.53	0.52	0.52	0.08	0.05	0.04	0.15	0.10	0.08	n/a	n/a	n/a
3 (76)	0.61	0.57	0.56	0.30	0.19	0.15	0.54	0.53	0.53	0.12	0.08	0.06	0.25	0.16	0.13	n/a	n/a	n/a
4 (102)	0.65	0.59	0.57	0.35	0.22	0.17	0.56	0.54	0.54	0.19	0.12	0.10	0.35	0.22	0.17	n/a	n/a	n/a
5 (127)	0.68	0.62	0.59	0.41	0.25	0.20	0.57	0.55	0.54	0.27	0.17	0.14	0.41	0.25	0.20	n/a	n/a	n/a
5-11/16 (145)	0.71	0.63	0.61	0.45	0.28	0.22	0.58	0.56	0.55	0.33	0.21	0.17	0.45	0.28	0.22	0.56	n/a	n/a
6 (152)	0.72	0.64	0.61	0.47	0.29	0.23	0.58	0.56	0.55	0.35	0.22	0.18	0.47	0.29	0.23	0.58	n/a	n/a
7 (178)	0.76	0.66	0.63	0.54	0.34	0.27	0.60	0.57	0.56	0.44	0.28	0.23	0.54	0.34	0.27	0.62	n/a	n/a
8 (203)	0.79	0.69	0.65	0.62	0.38	0.30	0.61	0.58	0.57	0.54	0.35	0.28	0.62	0.38	0.30	0.67	n/a	n/a
8-1/4 (210)	0.80	0.69	0.65	0.64	0.40	0.31	0.61	0.58	0.57	0.57	0.36	0.29	0.64	0.40	0.31	0.68	0.58	n/a
9 (229)	0.83	0.71	0.67	0.70	0.43	0.34	0.62	0.59	0.58	0.65	0.41	0.33	0.70	0.43	0.34	0.71	0.61	n/a
10-1/16 (256)	0.87	0.74	0.69	0.78	0.48	0.38	0.64	0.60	0.59	0.76	0.49	0.39	0.78	0.48	0.38	0.75	0.64	0.60
11 (279)	0.90	0.76	0.71	0.85	0.53	0.42	0.65	0.61	0.60	0.87	0.56	0.44	0.85	0.53	0.42	0.78	0.67	0.62
12 (305)	0.94	0.78	0.72	0.93	0.58	0.45	0.67	0.62	0.61	0.99	0.63	0.51	0.93	0.58	0.45	0.81	0.70	0.65
14 (356)	1.00	0.83	0.76	1.00	0.67	0.53	0.69	0.64	0.62	1.00	0.80	0.64	1.00	0.67	0.53	0.88	0.76	0.70
16 (406)		0.88	0.80		0.77	0.61	0.72	0.66	0.64		0.98	0.78		0.77	0.61	0.94	0.81	0.75
18 (457)		0.92	0.84		0.87	0.68	0.75	0.68	0.66		1.00	0.93		0.87	0.68	1.00	0.86	0.80
24 (610)		1.00	0.95		1.00	0.91	0.83	0.75	0.71			1.00		1.00	0.91	0.99	0.92	
30 (762)			1.00			1.00	0.91	0.81	0.76					1.00		1.00	1.00	
36 (914)							1.00	0.87	0.82									
> 48 (1219)								0.99	0.92									

Table 62 - Load adjustment factors for 10M rebar in cracked concrete^{1,2,3}

10M cracked concrete	Spacing factor in tension f_{AN}			Edge distance factor in tension f_{RN}			Spacing factor in shear ⁴ f_{AV}			Edge distance in shear						Concrete thickness factor in shear ⁵ f_{HV}		
										⊥ Toward edge f_{RV}			∥ To and away from edge f_{RV}					
	Embedment h_{ef} in. (mm)	4-1/2 (115)	7-1/16 (180)	8-7/8 (226)	4-1/2 (115)	7-1/16 (180)	8-7/8 (226)	4-1/2 (115)	7-1/16 (180)	8-8/9 (226)	4-1/2 (115)	7-1/16 (180)	8-7/8 (226)	4-1/2 (115)	7-1/16 (180)	8-7/8 (226)	4-1/2 (115)	7-1/16 (180)
1-3/4 (44)	n/a	n/a	n/a	0.49	0.44	0.42	n/a	n/a	n/a	0.05	0.03	0.03	0.10	0.07	0.05	n/a	n/a	n/a
2-3/16 (55)	0.58	0.55	0.54	0.52	0.46	0.43	0.53	0.52	0.52	0.07	0.04	0.04	0.14	0.09	0.07	n/a	n/a	n/a
3 (76)	0.61	0.57	0.56	0.60	0.50	0.47	0.54	0.53	0.53	0.11	0.07	0.06	0.23	0.15	0.12	n/a	n/a	n/a
4 (102)	0.65	0.59	0.57	0.70	0.56	0.51	0.55	0.54	0.53	0.18	0.11	0.09	0.35	0.23	0.18	n/a	n/a	n/a
5 (127)	0.68	0.62	0.59	0.80	0.62	0.56	0.57	0.55	0.54	0.25	0.16	0.13	0.49	0.32	0.25	n/a	n/a	n/a
5-11/16 (145)	0.71	0.63	0.61	0.88	0.66	0.59	0.57	0.56	0.55	0.30	0.19	0.15	0.60	0.39	0.31	0.55	n/a	n/a
6 (152)	0.72	0.64	0.61	0.91	0.68	0.61	0.58	0.56	0.55	0.32	0.21	0.17	0.65	0.41	0.33	0.56	n/a	n/a
7 (178)	0.76	0.66	0.63	1.00	0.74	0.65	0.59	0.57	0.56	0.41	0.26	0.21	0.82	0.52	0.42	0.61	n/a	n/a
8 (203)	0.79	0.69	0.65		0.81	0.70	0.60	0.58	0.57	0.50	0.32	0.25	1.00	0.64	0.51	0.65	n/a	n/a
8-1/4 (210)	0.80	0.69	0.65		0.83	0.72	0.61	0.58	0.57	0.53	0.34	0.27		0.67	0.53	0.66	0.57	n/a
9 (229)	0.83	0.71	0.67		0.88	0.76	0.62	0.59	0.58	0.60	0.38	0.30		0.76	0.61	0.69	0.59	n/a
10-1/16 (256)	0.87	0.74	0.69		0.96	0.81	0.63	0.60	0.58	0.71	0.45	0.36		0.90	0.72	0.73	0.63	0.58
11 (279)	0.90	0.76	0.71		1.00	0.86	0.64	0.61	0.59	0.81	0.51	0.41		1.00	0.82	0.76	0.65	0.61
12 (305)	0.94	0.78	0.72			0.92	0.66	0.62	0.60	0.92	0.59	0.47		0.92	0.79	0.79	0.68	0.63
14 (356)	1.00	0.83	0.76		1.00		0.68	0.64	0.62	1.00	0.74	0.59		1.00		0.86	0.74	0.68
16 (406)		0.88	0.80				0.71	0.66	0.63		0.90	0.72				0.92	0.79	0.73
18 (457)		0.92	0.84				0.74	0.68	0.65		1.00	0.86				0.97	0.84	0.78
24 (610)		1.00	0.95				0.81	0.73	0.70			1.00				1.00	0.97	0.90
30 (762)			1.00				0.89	0.79	0.75								1.00	1.00
36 (914)							0.97	0.85	0.80									
> 48 (1219)							1.00	0.97	0.90									

- 1 Linear interpolation not permitted.
- 2 Shaded area with reduced edge distance is permitted provided the rebar has no installation torque.
- 3 When combining multiple load adjustment factors (e.g. for a four-anchor pattern in a corner with thin concrete member) the design can become very conservative. To optimize the design, use Hilti PROFIS Anchor Design software or perform anchor calculation using design equations from CSA A23.3-14 Annex D.
- 4 Spacing factor reduction in shear applicable when $c < 3 \cdot h_{ef}$. f_{AV} is applicable when edge distance, $c < 3 \cdot h_{ef}$. If $c \geq 3 \cdot h_{ef}$, then $f_{AV} = f_{AN}$.
- 5 Concrete thickness reduction factor in shear, f_{HV} , is applicable when edge distance, $c < 3 \cdot h_{ef}$. If $c \geq 3 \cdot h_{ef}$, then $f_{HV} = 1.0$.



Table 63 - Load adjustment factors for 15M rebar in uncracked concrete^{1,2,3}

15M uncracked concrete	Spacing factor in tension			Edge distance factor in tension			Spacing factor in shear ⁴			Edge distance in shear						Concrete thickness factor in shear ⁵		
										⊥ Toward edge			∥ To and away from edge					
	f_{AN}	f_{RN}	f_{AV}	f_{RV}	f_{RV}	f_{RV}	f_{RV}	f_{RV}	f_{RV}	f_{RV}	f_{RV}	f_{RV}	f_{RV}	f_{RV}	f_{RV}	f_{RV}	f_{RV}	f_{RV}
Embedment h_{ef} in. (mm)	5-11/16 (145)	9-13/16 (250)	12-5/8 (320)	5-11/16 (145)	9-13/16 (250)	12-5/8 (320)	5-11/16 (145)	9-13/16 (250)	12-5/8 (320)	5-11/16 (145)	9-13/16 (250)	12-5/8 (320)	5-11/16 (145)	9-13/16 (250)	12-5/8 (320)	5-11/16 (145)	9-13/16 (250)	12-5/8 (320)
1-3/4 (44)	n/a	n/a	n/a	0.24	0.14	0.11	n/a	n/a	n/a	0.04	0.02	0.02	0.08	0.04	0.03	n/a	n/a	n/a
3-1/8 (80)	0.59	0.55	0.54	0.29	0.17	0.13	0.54	0.52	0.52	0.10	0.05	0.04	0.20	0.11	0.08	n/a	n/a	n/a
4 (102)	0.61	0.57	0.55	0.33	0.19	0.14	0.55	0.53	0.53	0.14	0.08	0.06	0.29	0.15	0.12	n/a	n/a	n/a
5 (127)	0.64	0.58	0.57	0.37	0.21	0.16	0.56	0.54	0.53	0.20	0.11	0.08	0.37	0.21	0.16	n/a	n/a	n/a
6 (152)	0.67	0.60	0.58	0.41	0.23	0.18	0.57	0.54	0.54	0.27	0.14	0.11	0.41	0.23	0.18	n/a	n/a	n/a
7 (178)	0.70	0.62	0.59	0.46	0.26	0.20	0.58	0.55	0.54	0.33	0.18	0.14	0.46	0.26	0.20	n/a	n/a	n/a
7-1/4 (184)	0.71	0.62	0.60	0.47	0.26	0.20	0.58	0.55	0.55	0.35	0.18	0.14	0.47	0.26	0.20	0.58	n/a	n/a
8 (203)	0.73	0.64	0.61	0.50	0.28	0.22	0.59	0.56	0.55	0.41	0.21	0.17	0.50	0.28	0.22	0.61	n/a	n/a
9 (229)	0.76	0.65	0.62	0.56	0.31	0.24	0.60	0.57	0.56	0.49	0.26	0.20	0.56	0.31	0.24	0.64	n/a	n/a
10 (254)	0.78	0.67	0.63	0.62	0.35	0.27	0.61	0.57	0.56	0.57	0.30	0.23	0.62	0.35	0.27	0.68	n/a	n/a
11-3/8 (289)	0.82	0.69	0.65	0.71	0.40	0.31	0.63	0.58	0.57	0.69	0.36	0.28	0.71	0.40	0.31	0.72	0.58	n/a
12 (305)	0.84	0.70	0.66	0.74	0.42	0.32	0.64	0.59	0.58	0.75	0.39	0.31	0.74	0.42	0.32	0.74	0.60	n/a
14-1/8 (359)	0.90	0.74	0.69	0.88	0.49	0.38	0.66	0.61	0.59	0.96	0.50	0.39	0.88	0.49	0.38	0.81	0.65	0.60
16 (406)	0.96	0.77	0.71	0.99	0.56	0.43	0.68	0.62	0.60	1.00	0.61	0.47	0.99	0.56	0.43	0.86	0.69	0.64
18 (457)	1.00	0.80	0.74	1.00	0.63	0.48	0.71	0.63	0.61		0.72	0.56	1.00	0.63	0.48	0.91	0.73	0.67
20 (508)		0.84	0.76		0.70	0.54	0.73	0.65	0.63		0.85	0.66		0.70	0.54	0.96	0.77	0.71
22 (559)		0.87	0.79		0.77	0.59	0.75	0.66	0.64		0.98	0.76		0.77	0.59	1.00	0.81	0.75
24 (610)		0.91	0.82		0.83	0.65	0.78	0.68	0.65		1.00	0.87		0.83	0.65		0.85	0.78
30 (762)		1.00	0.90		1.00	0.81	0.84	0.72	0.69			1.00		1.00	0.81		0.95	0.87
36 (914)			0.98			0.97	0.91	0.77	0.73						0.97		1.00	0.95
> 48 (1219)			1.00			1.00	1.00	0.86	0.80						1.00			1.00

3.2.3

Table 64 - Load adjustment factors for 15M rebar in cracked concrete^{1,2,3}



15M cracked concrete	Spacing factor in tension			Edge distance factor in tension			Spacing factor in shear ⁴			Edge distance in shear						Concrete thickness factor in shear ⁵		
										⊥ Toward edge			∥ To and away from edge					
	f_{AN}	f_{RN}	f_{AV}	f_{RV}	f_{RV}	f_{RV}	f_{RV}	f_{RV}	f_{RV}	f_{RV}	f_{RV}	f_{RV}	f_{RV}	f_{RV}	f_{RV}	f_{RV}	f_{RV}	f_{RV}
Embedment h_{ef} in. (mm)	5-11/16 (145)	9-13/16 (250)	12-5/8 (320)	5-11/16 (145)	9-13/16 (250)	12-5/8 (320)	5-11/16 (145)	9-13/16 (250)	12-5/8 (320)	5-11/16 (145)	9-13/16 (250)	12-5/8 (320)	5-11/16 (145)	9-13/16 (250)	12-5/8 (320)	5-11/16 (145)	9-13/16 (250)	12-5/8 (320)
1-3/4 (44)	n/a	n/a	n/a	0.46	0.41	0.40	n/a	n/a	n/a	0.04	0.02	0.02	0.09	0.04	0.03	n/a	n/a	n/a
3-1/8 (80)	0.59	0.55	0.54	0.55	0.46	0.44	0.54	0.52	0.52	0.10	0.05	0.04	0.21	0.09	0.07	n/a	n/a	n/a
4 (102)	0.61	0.57	0.55	0.61	0.50	0.46	0.55	0.53	0.52	0.15	0.07	0.05	0.29	0.13	0.10	n/a	n/a	n/a
5 (127)	0.64	0.58	0.57	0.68	0.54	0.49	0.56	0.53	0.53	0.21	0.09	0.07	0.41	0.19	0.15	n/a	n/a	n/a
6 (152)	0.67	0.60	0.58	0.76	0.58	0.52	0.57	0.54	0.53	0.27	0.12	0.10	0.54	0.25	0.19	n/a	n/a	n/a
7 (178)	0.70	0.62	0.59	0.84	0.62	0.56	0.58	0.55	0.54	0.34	0.15	0.12	0.68	0.31	0.24	n/a	n/a	n/a
7-1/4 (184)	0.71	0.62	0.60	0.86	0.63	0.56	0.58	0.55	0.54	0.36	0.16	0.13	0.72	0.33	0.25	0.58	n/a	n/a
8 (203)	0.73	0.64	0.61	0.93	0.66	0.59	0.59	0.55	0.55	0.42	0.19	0.15	0.83	0.38	0.30	0.61	n/a	n/a
9 (229)	0.76	0.65	0.62	1.00	0.71	0.62	0.60	0.56	0.55	0.50	0.23	0.18	0.99	0.45	0.35	0.65	n/a	n/a
10 (254)	0.78	0.67	0.63		0.76	0.66	0.62	0.57	0.56	0.58	0.26	0.21	1.00	0.53	0.41	0.68	n/a	n/a
11-3/8 (289)	0.82	0.69	0.65		0.82	0.71	0.63	0.58	0.57	0.71	0.32	0.25		0.64	0.50	0.73	0.56	n/a
12 (305)	0.84	0.70	0.66		0.86	0.73	0.64	0.58	0.57	0.77	0.35	0.27		0.69	0.54	0.75	0.57	n/a
14-1/8 (359)	0.90	0.74	0.69		0.97	0.81	0.66	0.60	0.58	0.98	0.44	0.35		0.89	0.69	0.81	0.62	0.57
16 (406)	0.96	0.77	0.71		1.00	0.88	0.69	0.61	0.59	1.00	0.53	0.42		1.00	0.84	0.86	0.66	0.61
18 (457)	1.00	0.80	0.74			0.96	0.71	0.62	0.60		0.64	0.50			0.96	0.91	0.70	0.65
20 (508)		0.84	0.76			1.00	0.73	0.64	0.62		0.75	0.58			1.00	0.96	0.74	0.68
22 (559)		0.87	0.79				0.76	0.65	0.63		0.86	0.67				1.00	0.78	0.72
24 (610)		0.91	0.82				0.78	0.66	0.64		0.98	0.77					0.81	0.75
30 (762)		1.00	0.90				0.85	0.71	0.67		1.00	1.00					0.91	0.84
36 (914)			0.98				0.92	0.75	0.71								0.99	0.92
> 48 (1219)			1.00				1.00	0.83	0.78								1.00	1.00

- Linear interpolation not permitted.
- Shaded area with reduced edge distance is permitted provided the rebar has no installation torque.
- When combining multiple load adjustment factors (e.g. for a four-anchor pattern in a corner with thin concrete member) the design can become very conservative. To optimize the design, use Hilti PROFIS Anchor Design software or perform anchor calculation using design equations from CSA A23.3-14 Annex D.
- Spacing factor reduction in shear applicable when $c < 3 \cdot h_{ef}$. f_{AV} is applicable when edge distance, $c < 3 \cdot h_{ef}$. If $c \geq 3 \cdot h_{ef}$, then $f_{AV} = f_{AN}$.
- Concrete thickness reduction factor in shear, f_{HV} is applicable when edge distance, $c < 3 \cdot h_{ef}$. If $c \geq 3 \cdot h_{ef}$, then $f_{HV} = 1.0$.

Table 65 - Load adjustment factors for 20M rebar in uncracked concrete^{1,2,3}

20M uncracked concrete	Spacing factor in tension f_{AN}			Edge distance factor in tension f_{RN}			Spacing factor in shear ⁴ f_{AV}			Edge distance in shear						Concrete thickness factor in shear ⁵ f_{HV}			
										⊥ Toward edge f_{RV}			∥ To and away from edge f_{RV}						
	Embedment h_{ef} in. (mm)	7-7/8 (200)	14 (355)	15-3/8 (390)	7-7/8 (200)	14 (355)	15-3/8 (390)	7-7/8 (200)	14 (355)	15-3/8 (390)	7-7/8 (200)	14 (355)	15-3/8 (390)	7-7/8 (200)	14 (355)	15-3/8 (390)	7-7/8 (200)	14 (355)	15-3/8 (390)
Spacing (s) / edge distance (c_e) / concrete thickness (h_c) - in. (mm)	1-3/4 (44)	n/a	n/a	n/a	0.21	0.11	0.10	n/a	n/a	n/a	0.03	0.01	0.01	0.06	0.03	0.02	n/a	n/a	n/a
	3-7/8 (98)	0.58	0.55	0.54	0.26	0.14	0.13	0.53	0.52	0.52	0.09	0.04	0.04	0.18	0.09	0.08	n/a	n/a	n/a
	4 (102)	0.58	0.55	0.54	0.27	0.15	0.13	0.53	0.52	0.52	0.10	0.05	0.04	0.19	0.09	0.09	n/a	n/a	n/a
	5 (127)	0.61	0.56	0.55	0.30	0.16	0.15	0.54	0.53	0.53	0.13	0.07	0.06	0.27	0.13	0.12	n/a	n/a	n/a
	6 (152)	0.63	0.57	0.57	0.33	0.18	0.16	0.55	0.53	0.53	0.17	0.09	0.08	0.33	0.17	0.16	n/a	n/a	n/a
	7 (178)	0.65	0.58	0.58	0.36	0.19	0.18	0.56	0.54	0.54	0.22	0.11	0.10	0.36	0.19	0.18	n/a	n/a	n/a
	8 (203)	0.67	0.60	0.59	0.39	0.21	0.19	0.57	0.54	0.54	0.27	0.13	0.12	0.39	0.21	0.19	n/a	n/a	n/a
	9 (229)	0.69	0.61	0.60	0.42	0.23	0.21	0.58	0.55	0.55	0.32	0.16	0.15	0.42	0.23	0.21	n/a	n/a	n/a
	10 (254)	0.71	0.62	0.61	0.46	0.25	0.23	0.59	0.55	0.55	0.38	0.19	0.17	0.46	0.25	0.23	0.59	n/a	n/a
	11 (279)	0.73	0.63	0.62	0.50	0.27	0.25	0.60	0.56	0.56	0.43	0.22	0.20	0.50	0.27	0.25	0.62	n/a	n/a
	12 (305)	0.75	0.64	0.63	0.54	0.30	0.27	0.60	0.57	0.56	0.49	0.25	0.22	0.54	0.30	0.27	0.65	n/a	n/a
	14 (356)	0.80	0.67	0.65	0.63	0.34	0.31	0.62	0.58	0.57	0.62	0.31	0.28	0.63	0.34	0.31	0.70	n/a	n/a
	16 (406)	0.84	0.69	0.67	0.72	0.39	0.36	0.64	0.59	0.58	0.76	0.38	0.34	0.72	0.39	0.36	0.74	0.59	n/a
	18 (457)	0.88	0.71	0.70	0.81	0.44	0.40	0.66	0.60	0.59	0.91	0.45	0.41	0.81	0.44	0.40	0.79	0.63	0.61
	20 (508)	0.92	0.74	0.72	0.90	0.49	0.45	0.67	0.61	0.60	1.00	0.53	0.48	0.90	0.49	0.45	0.83	0.66	0.64
	22 (559)	0.97	0.76	0.74	0.99	0.54	0.49	0.69	0.62	0.61		0.61	0.56	0.99	0.54	0.49	0.87	0.69	0.67
	24 (610)	1.00	0.79	0.76	1.00	0.59	0.54	0.71	0.63	0.62		0.70	0.63	1.00	0.59	0.54	0.91	0.72	0.70
	26 (660)		0.81	0.78		0.64	0.58	0.73	0.64	0.63		0.79	0.72		0.64	0.58	0.95	0.75	0.73
	28 (711)		0.83	0.80		0.69	0.62	0.74	0.65	0.64		0.88	0.80		0.69	0.62	0.99	0.78	0.76
	30 (762)		0.86	0.83		0.74	0.67	0.76	0.66	0.65		0.97	0.89		0.74	0.67	1.00	0.81	0.78
36 (914)		0.93	0.89		0.89	0.80	0.81	0.70	0.68		1.00	1.00		0.89	0.80		0.89	0.86	
> 48 (1219)		1.00	1.00		1.00	1.00	0.92	0.76	0.75					1.00	1.00		1.00	0.99	

Table 66 - Load adjustment factors for 20M rebar in cracked concrete^{1,2,3}

20M cracked concrete	Spacing factor in tension f_{AN}			Edge distance factor in tension f_{RN}			Spacing factor in shear ⁴ f_{AV}			Edge distance in shear						Concrete thickness factor in shear ⁵ f_{HV}			
										⊥ Toward edge f_{RV}			∥ To and away from edge f_{RV}						
	Embedment h_{ef} in. (mm)	7-7/8 (200)	14 (355)	15-3/8 (390)	7-7/8 (200)	14 (355)	15-3/8 (390)	7-7/8 (200)	14 (355)	15-3/8 (390)	7-7/8 (200)	14 (355)	15-3/8 (390)	7-7/8 (200)	14 (355)	15-3/8 (390)	7-7/8 (200)	14 (355)	15-3/8 (390)
Spacing (s) / edge distance (c_e) / concrete thickness (h_c) - in. (mm)	1-3/4 (44)	n/a	n/a	n/a	0.43	0.39	0.39	n/a	n/a	n/a	0.03	0.01	0.01	0.06	0.02	0.02	n/a	n/a	n/a
	3-7/8 (98)	0.58	0.55	0.54	0.53	0.45	0.44	0.53	0.52	0.52	0.09	0.04	0.04	0.18	0.08	0.07	n/a	n/a	n/a
	4 (102)	0.58	0.55	0.54	0.54	0.45	0.44	0.54	0.52	0.52	0.10	0.04	0.04	0.19	0.08	0.07	n/a	n/a	n/a
	5 (127)	0.61	0.56	0.55	0.59	0.48	0.47	0.54	0.52	0.52	0.14	0.06	0.05	0.27	0.11	0.10	n/a	n/a	n/a
	6 (152)	0.63	0.57	0.57	0.64	0.51	0.49	0.55	0.53	0.53	0.18	0.08	0.07	0.36	0.15	0.14	n/a	n/a	n/a
	7 (178)	0.65	0.58	0.58	0.70	0.53	0.52	0.56	0.53	0.53	0.22	0.09	0.09	0.45	0.19	0.17	n/a	n/a	n/a
	8 (203)	0.67	0.60	0.59	0.76	0.56	0.54	0.57	0.54	0.54	0.27	0.12	0.10	0.55	0.23	0.21	n/a	n/a	n/a
	9 (229)	0.69	0.61	0.60	0.82	0.59	0.57	0.58	0.54	0.54	0.33	0.14	0.12	0.65	0.28	0.25	n/a	n/a	n/a
	10 (254)	0.71	0.62	0.61	0.88	0.62	0.60	0.59	0.55	0.55	0.38	0.16	0.15	0.77	0.32	0.29	0.59	n/a	n/a
	11 (279)	0.73	0.63	0.62	0.95	0.65	0.62	0.60	0.55	0.55	0.44	0.19	0.17	0.88	0.37	0.34	0.62	n/a	n/a
	12 (305)	0.75	0.64	0.63	1.00	0.69	0.65	0.61	0.56	0.56	0.50	0.21	0.19	1.00	0.43	0.38	0.65	n/a	n/a
	14 (356)	0.80	0.67	0.65		0.75	0.71	0.62	0.57	0.56	0.64	0.27	0.24		0.54	0.48	0.70	n/a	n/a
	16 (406)	0.84	0.69	0.67		0.82	0.77	0.64	0.58	0.57	0.77	0.33	0.30		0.66	0.59	0.75	0.56	n/a
	18 (457)	0.88	0.71	0.70		0.89	0.83	0.66	0.59	0.58	0.93	0.39	0.35		0.78	0.71	0.80	0.60	0.58
	20 (508)	0.92	0.74	0.72		0.96	0.90	0.68	0.60	0.59	1.00	0.46	0.41		0.92	0.83	0.84	0.63	0.61
	22 (559)	0.97	0.76	0.74		1.00	0.96	0.69	0.61	0.60		0.53	0.48		1.00	0.95	0.88	0.66	0.64
	24 (610)	1.00	0.79	0.76			1.00	0.71	0.62	0.61		0.60	0.54			1.00	0.92	0.69	0.67
	26 (660)		0.81	0.78				0.73	0.63	0.62		0.68	0.61				0.96	0.72	0.69
	28 (711)		0.83	0.80				0.75	0.64	0.63		0.76	0.68				0.99	0.74	0.72
	30 (762)		0.86	0.83				0.76	0.65	0.64		0.84	0.76				1.00	0.77	0.74
36 (914)		0.93	0.89				0.82	0.68	0.67		1.00	1.00					0.84	0.82	
> 48 (1219)		1.00	1.00				0.92	0.74	0.72								0.98	0.94	

- Linear interpolation not permitted.
- Shaded area with reduced edge distance is permitted provided the rebar has no installation torque.
- When combining multiple load adjustment factors (e.g. for a four-anchor pattern in a corner with thin concrete member) the design can become very conservative. To optimize the design, use Hilti PROFIS Anchor Design software or perform anchor calculation using design equations from CSA A23.3-14 Annex D.
- Spacing factor reduction in shear applicable when $c < 3h_{ef}$, f_{AV} is applicable when edge distance, $c < 3h_{ef}$. If $c \geq 3h_{ef}$, then $f_{AV} = f_{AN}$.
- Concrete thickness reduction factor in shear, f_{HV} is applicable when edge distance, $c < 3h_{ef}$. If $c \geq 3h_{ef}$, then $f_{HV} = 1.0$.



Table 67 - Load adjustment factors for 25M rebar in uncracked concrete^{1,2,3}

25M uncracked concrete	Spacing factor in tension			Edge distance factor in tension			Spacing factor in shear ⁴			Edge distance in shear						Concrete thickness factor in shear ⁵		
										⊥ Toward edge			∥ To and away from edge					
	f_{AN}	f_{RN}	f_{AV}	f_{RV}	f_{RV}	f_{RV}	f_{RV}	f_{RV}	f_{RV}	f_{RV}	f_{RV}	f_{RV}	f_{RV}	f_{RV}	f_{RV}	f_{RV}	f_{RV}	f_{RV}
Embedment h_{ef} in. (mm)	9-1/16 (230)	15-15/16 (405)	19-13/16 (504)	9-1/16 (230)	15-15/16 (405)	19-13/16 (504)	9-1/16 (230)	15-15/16 (405)	19-13/16 (504)	9-1/16 (230)	15-15/16 (405)	19-13/16 (504)	9-1/16 (230)	15-15/16 (405)	19-13/16 (504)	9-1/16 (230)	15-15/16 (405)	19-13/16 (504)
1-3/4 (44)	n/a	n/a	n/a	0.24	0.12	0.10	n/a	n/a	n/a	0.02	0.01	0.01	0.04	0.02	0.02	n/a	n/a	n/a
5 (127)	0.59	0.55	0.54	0.32	0.16	0.13	0.54	0.52	0.52	0.11	0.05	0.04	0.22	0.09	0.07	n/a	n/a	n/a
6 (152)	0.61	0.56	0.55	0.34	0.18	0.14	0.55	0.53	0.52	0.14	0.06	0.05	0.28	0.12	0.10	n/a	n/a	n/a
7 (178)	0.63	0.57	0.56	0.37	0.19	0.15	0.55	0.53	0.53	0.18	0.08	0.06	0.36	0.15	0.12	n/a	n/a	n/a
8 (203)	0.65	0.58	0.57	0.40	0.21	0.16	0.56	0.53	0.53	0.22	0.09	0.07	0.40	0.19	0.15	n/a	n/a	n/a
9 (229)	0.67	0.59	0.58	0.43	0.22	0.18	0.57	0.54	0.53	0.26	0.11	0.09	0.43	0.22	0.18	n/a	n/a	n/a
10 (254)	0.68	0.60	0.58	0.46	0.24	0.19	0.58	0.54	0.54	0.30	0.13	0.10	0.46	0.24	0.19	n/a	n/a	n/a
11-9/16 (294)	0.71	0.62	0.60	0.51	0.26	0.21	0.59	0.55	0.54	0.38	0.16	0.13	0.51	0.26	0.21	0.59	n/a	n/a
12 (305)	0.72	0.63	0.60	0.52	0.27	0.21	0.59	0.55	0.54	0.40	0.17	0.14	0.52	0.27	0.21	0.60	n/a	n/a
14 (356)	0.76	0.65	0.62	0.59	0.31	0.24	0.61	0.56	0.55	0.50	0.22	0.17	0.59	0.31	0.24	0.65	n/a	n/a
16 (406)	0.79	0.67	0.63	0.68	0.35	0.28	0.62	0.57	0.56	0.62	0.26	0.21	0.68	0.35	0.28	0.69	n/a	n/a
18 (457)	0.83	0.69	0.65	0.76	0.39	0.31	0.64	0.58	0.57	0.74	0.31	0.25	0.76	0.39	0.31	0.74	n/a	n/a
18-7/16 (469)	0.84	0.69	0.66	0.78	0.40	0.32	0.64	0.58	0.57	0.76	0.33	0.26	0.78	0.40	0.32	0.75	0.56	n/a
20 (508)	0.87	0.71	0.67	0.85	0.44	0.35	0.65	0.59	0.57	0.86	0.37	0.30	0.85	0.44	0.35	0.78	0.59	n/a
22-3/8 (568)	0.91	0.73	0.69	0.95	0.49	0.39	0.67	0.60	0.58	1.00	0.44	0.35	0.95	0.49	0.39	0.82	0.62	0.58
24 (610)	0.94	0.75	0.70	1.00	0.52	0.42	0.68	0.60	0.59		0.48	0.39	1.00	0.52	0.42	0.85	0.64	0.60
26 (660)	0.98	0.77	0.72		0.57	0.45	0.70	0.61	0.60		0.55	0.44		0.57	0.45	0.89	0.67	0.62
28 (711)	1.00	0.79	0.74		0.61	0.49	0.71	0.62	0.60		0.61	0.49		0.61	0.49	0.92	0.69	0.64
30 (762)		0.81	0.75		0.66	0.52	0.73	0.63	0.61		0.68	0.54		0.66	0.52	0.95	0.72	0.67
36 (914)		0.88	0.80		0.79	0.63	0.77	0.65	0.63		0.89	0.71		0.79	0.63	1.00	0.79	0.73
> 48 (1219)		1.00	0.90		1.00	0.84	0.86	0.71	0.68		1.00	1.00		1.00	0.84		0.91	0.84

3.2.3

Table 68 - Load adjustment factors for 25M rebar in cracked concrete^{1,2,3}



25M cracked concrete	Spacing factor in tension			Edge distance factor in tension			Spacing factor in shear ⁴			Edge distance in shear						Concrete thickness factor in shear ⁵		
										⊥ Toward edge			∥ To and away from edge					
	f_{AN}	f_{RN}	f_{AV}	f_{RV}	f_{RV}	f_{RV}	f_{RV}	f_{RV}	f_{RV}	f_{RV}	f_{RV}	f_{RV}	f_{RV}	f_{RV}	f_{RV}	f_{RV}	f_{RV}	f_{RV}
Embedment h_{ef} in. (mm)	9-1/16 (230)	15-15/16 (405)	19-13/16 (504)	9-1/16 (230)	15-15/16 (405)	19-13/16 (504)	9-1/16 (230)	15-15/16 (405)	19-13/16 (504)	9-1/16 (230)	15-15/16 (405)	19-13/16 (504)	9-1/16 (230)	15-15/16 (405)	19-13/16 (504)	9-1/16 (230)	15-15/16 (405)	19-13/16 (504)
1-3/4 (44)	n/a	n/a	n/a	0.42	0.39	0.38	n/a	n/a	n/a	0.02	0.01	0.01	0.05	0.02	0.01	n/a	n/a	n/a
5 (127)	0.59	0.55	0.54	0.55	0.46	0.44	0.54	0.52	0.52	0.11	0.05	0.03	0.22	0.09	0.07	n/a	n/a	n/a
6 (152)	0.61	0.56	0.55	0.60	0.48	0.46	0.55	0.53	0.52	0.14	0.06	0.04	0.29	0.12	0.09	n/a	n/a	n/a
7 (178)	0.63	0.57	0.56	0.65	0.51	0.48	0.55	0.53	0.52	0.18	0.08	0.06	0.36	0.16	0.11	n/a	n/a	n/a
8 (203)	0.65	0.58	0.57	0.70	0.53	0.50	0.56	0.53	0.53	0.22	0.10	0.07	0.44	0.19	0.14	n/a	n/a	n/a
9 (229)	0.67	0.59	0.58	0.75	0.56	0.51	0.57	0.54	0.53	0.27	0.11	0.08	0.53	0.23	0.16	n/a	n/a	n/a
10 (254)	0.68	0.60	0.58	0.80	0.59	0.53	0.58	0.54	0.53	0.31	0.13	0.10	0.62	0.27	0.19	n/a	n/a	n/a
11-9/16 (294)	0.71	0.62	0.60	0.89	0.63	0.57	0.59	0.55	0.54	0.39	0.17	0.12	0.77	0.33	0.24	0.60	n/a	n/a
12 (305)	0.72	0.63	0.60	0.91	0.64	0.58	0.59	0.55	0.54	0.41	0.17	0.13	0.82	0.35	0.25	0.61	n/a	n/a
14 (356)	0.76	0.65	0.62	1.00	0.69	0.62	0.61	0.56	0.55	0.51	0.22	0.16	1.00	0.44	0.32	0.65	n/a	n/a
16 (406)	0.79	0.67	0.63		0.75	0.66	0.62	0.57	0.56	0.63	0.27	0.19		0.54	0.39	0.70	n/a	n/a
18 (457)	0.83	0.69	0.65		0.81	0.71	0.64	0.58	0.56	0.75	0.32	0.23		0.64	0.46	0.74	n/a	n/a
18-7/16 (469)	0.84	0.69	0.66		0.83	0.72	0.64	0.58	0.56	0.78	0.33	0.24		0.67	0.48	0.75	0.57	n/a
20 (508)	0.87	0.71	0.67		0.87	0.75	0.65	0.59	0.57	0.88	0.38	0.27		0.75	0.54	0.78	0.59	n/a
22-3/8 (568)	0.91	0.73	0.69		0.95	0.81	0.67	0.60	0.58	1.00	0.44	0.32		0.89	0.64	0.83	0.62	0.56
24 (610)	0.94	0.75	0.70		1.00	0.85	0.68	0.60	0.58		0.49	0.36		0.99	0.71	0.86	0.65	0.58
26 (660)	0.98	0.77	0.72			0.90	0.70	0.61	0.59		0.56	0.40		1.00	0.80	0.89	0.67	0.60
28 (711)	1.00	0.79	0.74			0.95	0.71	0.62	0.60		0.62	0.45			0.90	0.93	0.70	0.63
30 (762)		0.81	0.75			1.00	0.73	0.63	0.60		0.69	0.50			1.00	0.96	0.72	0.65
36 (914)		0.88	0.80				0.78	0.66	0.63		0.91	0.65				1.00	0.79	0.71
> 48 (1219)		1.00	0.90				0.87	0.71	0.67		1.00	1.00					0.91	0.82

- Linear interpolation not permitted.
- Shaded area with reduced edge distance is permitted provided the rebar has no installation torque.
- When combining multiple load adjustment factors (e.g. for a four-anchor pattern in a corner with thin concrete member) the design can become very conservative. To optimize the design, use Hilti PROFIS Anchor Design software or perform anchor calculation using design equations from CSA A23.3-14 Annex D.
- Spacing factor reduction in shear applicable when $c < 3 \cdot h_{ef}$. f_{AV} is applicable when edge distance, $c < 3 \cdot h_{ef}$. If $c \geq 3 \cdot h_{ef}$, then $f_{AV} = f_{AN}$.
- Concrete thickness reduction factor in shear, f_{HV} is applicable when edge distance, $c < 3 \cdot h_{ef}$. If $c \geq 3 \cdot h_{ef}$, then $f_{HV} = 1.0$.

Table 69 - Load adjustment factors for 30M rebar in uncracked concrete^{1,2,3}

30M uncracked concrete	Spacing factor in tension			Edge distance factor in tension			Spacing factor in shear ⁴			Edge distance in shear						Concrete thickness factor in shear ⁵			
										⊥ Toward edge			∥ To and away from edge						
	f_{AN}	f_{RN}	f_{AV}	f_{RV}	f_{RV}	f_{RV}	f_{RV}	f_{RV}	f_{RV}	f_{RV}	f_{RV}	f_{RV}	f_{RV}	f_{RV}	f_{RV}	f_{RV}	f_{RV}	f_{RV}	
Embedment h_{ef} in. (mm)	10-1/4 (260)	17-15/16 (455)	23-9/16 (598)	10-1/4 (260)	17-15/16 (455)	23-9/16 (598)	10-1/4 (260)	17-15/16 (455)	23-9/16 (598)	10-1/4 (260)	17-15/16 (455)	23-9/16 (598)	10-1/4 (260)	17-15/16 (455)	23-9/16 (598)	10-1/4 (260)	17-15/16 (455)	23-9/16 (598)	
Spacing (s) / edge distance (c_e) / concrete thickness (h_c) - in. (mm)	1-3/4 (44)	n/a	n/a	n/a	0.25	0.13	0.10	n/a	n/a	n/a	0.02	0.01	0.01	0.04	0.02	0.01	n/a	n/a	n/a
	5-7/8 (150)	0.59	0.55	0.54	0.34	0.17	0.13	0.54	0.52	0.52	0.12	0.05	0.03	0.23	0.10	0.07	n/a	n/a	n/a
	6 (152)	0.59	0.56	0.54	0.34	0.18	0.13	0.54	0.52	0.52	0.12	0.05	0.04	0.24	0.10	0.07	n/a	n/a	n/a
	7 (178)	0.61	0.57	0.55	0.37	0.19	0.14	0.55	0.53	0.52	0.15	0.06	0.04	0.30	0.13	0.09	n/a	n/a	n/a
	8 (203)	0.63	0.57	0.56	0.39	0.20	0.15	0.55	0.53	0.52	0.18	0.08	0.05	0.36	0.16	0.11	n/a	n/a	n/a
	9 (229)	0.64	0.58	0.56	0.42	0.21	0.16	0.56	0.53	0.53	0.22	0.09	0.07	0.42	0.19	0.13	n/a	n/a	n/a
	10 (254)	0.66	0.59	0.57	0.45	0.23	0.17	0.57	0.54	0.53	0.25	0.11	0.08	0.45	0.22	0.15	n/a	n/a	n/a
	11 (279)	0.67	0.60	0.58	0.47	0.24	0.18	0.57	0.54	0.53	0.29	0.13	0.09	0.47	0.24	0.18	n/a	n/a	n/a
	12 (305)	0.69	0.61	0.58	0.50	0.25	0.19	0.58	0.55	0.54	0.33	0.14	0.10	0.50	0.25	0.19	n/a	n/a	n/a
	13-1/4 (337)	0.71	0.62	0.59	0.54	0.27	0.21	0.59	0.55	0.54	0.39	0.17	0.12	0.54	0.27	0.21	0.60	n/a	n/a
	14 (356)	0.72	0.63	0.60	0.56	0.28	0.21	0.59	0.55	0.54	0.42	0.18	0.13	0.56	0.28	0.21	0.61	n/a	n/a
	16 (406)	0.75	0.65	0.61	0.63	0.32	0.24	0.61	0.56	0.55	0.51	0.22	0.15	0.63	0.32	0.24	0.65	n/a	n/a
	18 (457)	0.78	0.67	0.63	0.71	0.35	0.27	0.62	0.57	0.55	0.61	0.26	0.18	0.71	0.35	0.27	0.69	n/a	n/a
	20 (508)	0.81	0.69	0.64	0.79	0.39	0.30	0.63	0.58	0.56	0.72	0.31	0.22	0.79	0.39	0.30	0.73	n/a	n/a
	20-7/8 (531)	0.83	0.69	0.65	0.82	0.41	0.31	0.64	0.58	0.56	0.77	0.33	0.23	0.82	0.41	0.31	0.75	n/a	n/a
	22 (559)	0.85	0.70	0.66	0.87	0.43	0.33	0.65	0.58	0.57	0.83	0.36	0.25	0.87	0.43	0.33	0.77	0.58	n/a
	24 (610)	0.88	0.72	0.67	0.94	0.47	0.36	0.66	0.59	0.57	0.94	0.41	0.28	0.94	0.47	0.36	0.80	0.61	n/a
	26-9/16 (675)	0.92	0.75	0.69	1.00	0.52	0.39	0.68	0.60	0.58	1.00	0.47	0.33	1.00	0.52	0.39	0.84	0.64	0.56
	28 (711)	0.94	0.76	0.70		0.55	0.42	0.69	0.61	0.58		0.51	0.36		0.55	0.42	0.86	0.65	0.58
	30 (762)	0.97	0.78	0.71		0.59	0.44	0.70	0.61	0.59		0.57	0.40		0.59	0.44	0.89	0.68	0.60
36 (914)	1.00	0.83	0.75		0.71	0.53	0.74	0.64	0.61		0.75	0.52		0.71	0.53	0.98	0.74	0.66	
> 48 (1219)		0.95	0.84		0.95	0.71	0.82	0.68	0.64		1.00	0.80		0.95	0.71	1.00	0.86	0.76	

Table 70 - Load adjustment factors for 30M rebar in cracked concrete^{1,2,3}

30M cracked concrete	Spacing factor in tension			Edge distance factor in tension			Spacing factor in shear ⁴			Edge distance in shear						Concrete thickness factor in shear ⁵			
										⊥ Toward edge			∥ To and away from edge						
	f_{AN}	f_{RN}	f_{AV}	f_{RV}	f_{RV}	f_{RV}	f_{RV}	f_{RV}	f_{RV}	f_{RV}	f_{RV}	f_{RV}	f_{RV}	f_{RV}	f_{RV}	f_{RV}	f_{RV}	f_{RV}	f_{RV}
Embedment h_{ef} in. (mm)	10-1/4 (260)	17-15/16 (455)	23-9/16 (598)	10-1/4 (260)	17-15/16 (455)	23-9/16 (598)	10-1/4 (260)	17-15/16 (455)	23-9/16 (598)	10-1/4 (260)	17-15/16 (455)	23-9/16 (598)	10-1/4 (260)	17-15/16 (455)	23-9/16 (598)	10-1/4 (260)	17-15/16 (455)	23-9/16 (598)	
Spacing (s) / edge distance (c_e) / concrete thickness (h_c) - in. (mm)	1-3/4 (44)	n/a	n/a	n/a	0.41	0.38	0.38	n/a	n/a	n/a	0.02	0.01	0.01	0.04	0.02	0.01	n/a	n/a	n/a
	5-7/8 (150)	0.59	0.55	0.54	0.56	0.47	0.44	0.54	0.52	0.52	0.12	0.05	0.03	0.23	0.10	0.07	n/a	n/a	n/a
	6 (152)	0.59	0.56	0.54	0.56	0.47	0.44	0.54	0.52	0.52	0.12	0.05	0.03	0.24	0.10	0.07	n/a	n/a	n/a
	7 (178)	0.61	0.57	0.55	0.60	0.49	0.46	0.55	0.53	0.52	0.15	0.07	0.04	0.30	0.13	0.09	n/a	n/a	n/a
	8 (203)	0.63	0.57	0.56	0.64	0.51	0.47	0.55	0.53	0.52	0.19	0.08	0.05	0.37	0.16	0.11	n/a	n/a	n/a
	9 (229)	0.64	0.58	0.56	0.68	0.53	0.49	0.56	0.53	0.53	0.22	0.10	0.06	0.44	0.19	0.13	n/a	n/a	n/a
	10 (254)	0.66	0.59	0.57	0.72	0.56	0.50	0.57	0.54	0.53	0.26	0.11	0.07	0.52	0.22	0.15	n/a	n/a	n/a
	11 (279)	0.67	0.60	0.58	0.77	0.58	0.52	0.57	0.54	0.53	0.30	0.13	0.09	0.60	0.26	0.17	n/a	n/a	n/a
	12 (305)	0.69	0.61	0.58	0.81	0.60	0.54	0.58	0.55	0.54	0.34	0.15	0.10	0.68	0.29	0.19	n/a	n/a	n/a
	13-1/4 (337)	0.71	0.62	0.59	0.87	0.63	0.56	0.59	0.55	0.54	0.40	0.17	0.11	0.79	0.34	0.23	0.60	n/a	n/a
	14 (356)	0.72	0.63	0.60	0.91	0.65	0.57	0.59	0.55	0.54	0.43	0.19	0.12	0.86	0.37	0.25	0.62	n/a	n/a
	16 (406)	0.75	0.65	0.61	1.00	0.70	0.61	0.61	0.56	0.55	0.52	0.23	0.15	1.00	0.45	0.30	0.66	n/a	n/a
	18 (457)	0.78	0.67	0.63		0.75	0.64	0.62	0.57	0.55	0.62	0.27	0.18		0.54	0.36	0.70	n/a	n/a
	20 (508)	0.81	0.69	0.64		0.81	0.68	0.64	0.58	0.56	0.73	0.32	0.21		0.63	0.42	0.74	n/a	n/a
	20-7/8 (531)	0.83	0.69	0.65		0.83	0.70	0.64	0.58	0.56	0.78	0.34	0.22		0.68	0.45	0.75	n/a	n/a
	22 (559)	0.85	0.70	0.66		0.86	0.72	0.65	0.59	0.56	0.84	0.36	0.24		0.73	0.48	0.77	0.58	n/a
	24 (610)	0.88	0.72	0.67		0.92	0.76	0.66	0.59	0.57	0.96	0.42	0.28		0.83	0.55	0.81	0.61	n/a
	26-9/16 (675)	0.92	0.75	0.69		0.99	0.81	0.68	0.60	0.58	1.00	0.48	0.32		0.97	0.64	0.85	0.64	0.56
	28 (711)	0.94	0.76	0.70		1.00	0.84	0.69	0.61	0.58		0.52	0.35		1.00	0.69	0.87	0.66	0.57
	30 (762)	0.97	0.78	0.71			0.88	0.70	0.62	0.59		0.58	0.39			0.77	0.90	0.68	0.59
36 (914)	1.00	0.83	0.75			1.00	0.74	0.64	0.61		0.76	0.51			1.00	0.99	0.75	0.65	
> 48 (1219)		0.95	0.84				0.82	0.69	0.64		1.00	0.78				1.00	0.86	0.75	

- Linear interpolation not permitted.
- Shaded area with reduced edge distance is permitted provided the rebar has no installation torque.
- When combining multiple load adjustment factors (e.g. for a four-anchor pattern in a corner with thin concrete member) the design can become very conservative. To optimize the design, use Hilti PROFIS Anchor Design software or perform anchor calculation using design equations from CSA A23.3-14 Annex D.
- Spacing factor reduction in shear applicable when $c < 3h_{ef}$. f_{AV} is applicable when edge distance, $c < 3h_{ef}$. If $c \geq 3h_{ef}$, then $f_{AV} = f_{AN}$.
- Concrete thickness reduction factor in shear, f_{HV} is applicable when edge distance, $c < 3h_{ef}$. If $c \geq 3h_{ef}$, then $f_{HV} = 1.0$.

HIT-RE 500 V3 adhesive with HAS Threaded Rod



Table 71 - Hilti HIT-RE 500 V3 design information with Hilti HAS threaded rods in hammer drilled holes in accordance with CSA A23.3-14 Annex D^{1,8}



Design parameter	Symbol	Units	Nominal rod diameter (in.)							Ref	
			3/8	1/2	5/8	3/4	7/8	1	1-1/4		
Nominal anchor diameter	d_a	mm	9.5	12.7	15.9	19.1	22.2	25.4	31.8	A23.3-14	
Effective minimum embedment ²	$h_{ef,min}$	mm	60	70	79	89	89	102	127		
Effective maximum embedment ²	$h_{ef,max}$	mm	191	254	318	381	445	508	635		
Min. concrete thickness ²	h_{min}	mm	$h_{ef} + 30$								
Critical edge distance	c_{ac}	-	$2h_{ef}$								
Minimum edge distance	c_{min}^3	mm	48	64	79	95	111	127	159		
Minimum anchor spacing	s_{min}	mm	48	64	79	95	111	127	159		
Coeff. for factored conc. breakout resistance, uncracked concrete	$k_{c,uncr}^4$	-	10							D.6.2.2	
Coeff. for factored conc. breakout resistance, cracked concrete	$k_{c,cr}^4$	-	7							D.6.2.2	
Concrete material resistance factor	ϕ_c	-	0.65							8.4.2	
Resistance modification factor for tension and shear, concrete failure modes, Condition B ⁵	R_{conc}	-	1.00							D.5.3(c)	
Dry and water saturated concrete											
Temp. range A ⁶	Characteristic bond stress in cracked concrete ^{6,7}	τ_{cr}	psi (MPa)	1,280 (8.8)	1,270 (8.8)	1,260 (8.7)	1,250 (8.6)	1,240 (8.6)	1,240 (8.6)	1,180 (8.1)	D.6.5.2
	Characteristic bond stress in uncracked concrete ^{6,7}	τ_{uncr}	psi (MPa)	2,380 (16.4)	2,300 (15.9)	2,210 (15.2)	2,130 (14.7)	2,040 (14.1)	1,960 (13.5)	1,790 (12.3)	D.6.5.2
Temp. range B ⁶	Characteristic bond stress in cracked concrete ^{6,7}	τ_{cr}	psi (MPa)	880 (6.1)	870 (6.0)	870 (6.0)	860 (5.9)	860 (5.9)	850 (5.9)	810 (5.6)	D.6.5.2
	Characteristic bond stress in uncracked concrete ^{6,7}	τ_{uncr}	psi (MPa)	1,640 (11.3)	1,590 (11.0)	1,530 (10.6)	1,470 (10.1)	1,410 (9.7)	1,350 (9.3)	1,240 (8.6)	D.6.5.2
Anchor category, dry concrete		-	-	1	1	1	1	1	1	1	
Resistance modification factor		R_{dry}	-	1.00	1.00	1.00	1.00	1.00	1.00	1.00	
Water-filled hole											
Temp. range A ⁶	Characteristic bond stress in cracked concrete ^{6,7}	τ_{cr}	psi (MPa)	940 (6.5)	940 (6.5)	940 (6.5)	940 (6.5)	940 (6.5)	950 (6.6)	920 (6.3)	D.6.5.2
	Characteristic bond stress in uncracked concrete ^{6,7}	τ_{uncr}	psi (MPa)	1,760 (12.1)	1,700 (11.7)	1,660 (11.4)	1,600 (11.0)	1,550 (10.7)	1,500 (10.3)	1,400 (9.7)	D.6.5.2
Temp. range B ⁶	Characteristic bond stress in cracked concrete ^{6,7}	τ_{cr}	psi (MPa)	650 (4.5)	650 (4.5)	650 (4.5)	650 (4.5)	650 (4.5)	650 (4.5)	640 (4.4)	D.6.5.2
	Characteristic bond stress in uncracked concrete ^{6,7}	τ_{uncr}	psi (MPa)	1,210 (8.3)	1,170 (8.1)	1,140 (7.9)	1,110 (7.7)	1,070 (7.4)	1,040 (7.2)	970 (6.7)	D.6.5.2
Anchor category, water-filled hole		-	-	3	3	3	3	3	3	3	
Resistance modification factor		R_{wf}	-	0.75	0.75	0.75	0.75	0.75	0.75	0.75	
Submerged concrete											
Temp. range A ⁶	Characteristic bond stress in cracked concrete ^{6,7}	τ_{cr}	psi (MPa)	820 (5.7)	830 (5.7)	830 (5.7)	840 (5.8)	850 (5.9)	860 (5.9)	860 (5.9)	D.6.5.2
	Characteristic bond stress in uncracked concrete ^{6,7}	τ_{uncr}	psi (MPa)	1,530 (10.6)	1,500 (10.3)	1,470 (10.1)	1,430 (9.9)	1,400 (9.7)	1,370 (9.4)	1,300 (9.0)	D.6.5.2
Temp. range B ⁶	Characteristic bond stress in cracked concrete ^{6,7}	τ_{cr}	psi (MPa)	570 (3.9)	570 (3.9)	580 (4.0)	580 (4.0)	590 (4.1)	590 (4.1)	590 (4.1)	D.6.5.2
	Characteristic bond stress in uncracked concrete ^{6,7}	τ_{uncr}	psi (MPa)	1,060 (7.3)	1,030 (7.1)	1,010 (7.0)	990 (6.8)	960 (6.6)	940 (6.5)	900 (6.2)	D.6.5.2
Anchor category, underwater		-	-	3	3	3	3	3	3	3	
Resistance modification factor		R_{uw}	-	0.75	0.75	0.75	0.75	0.75	0.75	0.75	
Reduction for seismic tension		$\alpha_{N,seis}$	-	0.92	0.93	0.95	1.00	1.00	1.00	1.00	

3.2.3

- Design information in this table is taken from ICC-ES ELC-3814, dated April 2018, tables 8 and 9, and converted for use with CSA A23.3-14 Annex D.
- See figure 4 of section 3.2.4.3.4.
- Minimum edge distance may be reduced to $45\text{mm} \leq c_{ai} < 5d$ provided T_{inst} is reduced. See ESR-3814 section 4.1.9.
- For all design cases, $\psi_{c,N} = 1.0$. The appropriate coefficient for breakout resistance for cracked concrete ($k_{c,cr}$) or uncracked concrete ($k_{c,uncr}$) must be used.
- For use with the load combinations of CSA A23.3-14 chapter 8. Condition B applies where supplementary reinforcement in conformance with CSA A23.3-14 section D.5.3 is not provided, or where pullout or pryout strength governs. For cases where the presence of supplementary reinforcement can be verified, the resistance modification factors associated with Condition A may be used.
- Temperature range A: Max. short term temperature = 130°F (55°C), max. long term temperature = 110°F (43°C).
Temperature range B: Max. short term temperature = 176°F (80°C), max. long term temperature = 110°F (43°C).
Short term elevated concrete temperatures are those that occur over brief intervals, e.g., as a result of diurnal cycling. Long term concrete temperatures are roughly constant over significant periods of time.
- Bond stress values corresponding to concrete compressive stress $f'_c = 2,500$ psi (17.2 MPa). For concrete compressive strength, f'_c , between 2,500 psi (17.2 MPa) and 8,000 psi (55.2 MPa), the tabulated characteristic bond stress may be increased by a factor of $(f'_c/2,500)^{0.25}$ [for SI: $(f'_c/17.2)^{0.25}$] for uncracked concrete and $(f'_c/2,500)^{0.15}$ [for SI: $(f'_c/17.2)^{0.15}$] for cracked concrete.
- For structures assigned to Seismic Design Categories C, D, E, or F, bond strength values must be multiplied by $\alpha_{N,seis}$.

Table 72 - Hilti HIT-RE 500 V3 design information with Hilti HAS threaded rods in diamond core drilled holes in accordance with CSA A23.3-14 Annex D¹

Design parameter	Symbol	Units	Nominal rod diameter (in.)							Ref A23.3-14	
			3/8	1/2	5/8	3/4	7/8	1	1-1/4		
Nominal anchor diameter	d_a	mm	9.5	12.7	15.9	19.1	22.2	25.4	31.8		
Effective minimum embedment ²	h_{ef}	mm	60	70	79	89	89	102	127		
Effective maximum embedment ²	h_{ef}	mm	191	254	318	381	445	508	635		
Minimum concrete thickness ²	h_{min}	mm	$h_{ef} + 30$		$h_{ef} + 2d_o$						
Critical edge distance	c_{ac}	-	$2h_{ef}$								
Minimum edge distance	c_{min}^3	mm	48	64	79	95	111	127	159		
Minimum anchor spacing	s_{min}	mm	48	64	79	95	111	127	159		
Coeff. for factored concrete breakout resistance, uncracked concrete	$k_{c,uncr}^4$	-	10							D.6.2.2	
Coeff. for factored concrete breakout resistance, cracked concrete	$k_{c,cr}^4$	-	7							D.6.2.2	
Concrete material resistance factor	ϕ_s	-	0.65							8.4.2	
Resistance modification factor for tension and shear, concrete failure modes, Condition B ⁵	R_{conc}	-	1.00							D.5.3(c)	
Dry and water saturated concrete											
Temp. range A ⁶	Characteristic bond stress in uncracked concrete ^{6,7}	τ_{uncr}	psi	1,550	1,550	1,550	1,550	1,550	1,550	1,550	D.6.5.2
			(MPa)	(10.7)	(10.7)	(10.7)	(10.7)	(10.7)	(10.7)	(10.7)	
Temp. range B ⁶	Characteristic bond stress in uncracked concrete ^{6,7}	τ_{uncr}	psi	1,070	1,070	1,070	1,070	1,070	1,070	1,070	D.6.5.2
			psi	(7.4)	(7.4)	(7.4)	(7.4)	(7.4)	(7.4)	(7.4)	
Anchor category, dry concrete		-	-	2	2	3	3	3	3	3	
Resistance modification factor		R_{dry}	-	0.85	0.85	0.75	0.75	0.75	0.75	0.75	

1 Design information in this table is taken from ICC-ES ELC-3814, dated April 2018, tables 8 and 10, and converted for use with CSA A23.3-14 Annex D.

2 See figure 4 of section 3.2.4.3.4.

3 Minimum edge distance may be reduced to $45\text{mm} \leq c_{al} < 5d$ provided T_{inst} is reduced. See ESR-3814 section 4.1.9.

4 For all design cases, $\psi_{c,N} = 1.0$. The appropriate coefficient for breakout resistance for cracked concrete ($k_{c,cr}$) or uncracked concrete ($k_{c,uncr}$) must be used.

5 For use with the load combinations of CSA A23.3-14 chapter 8. Condition B applies where supplementary reinforcement in conformance with CSA A23.3-14 section D.5.3 is not provided, or where pullout or pryout strength governs. For cases where the presence of supplementary reinforcement can be verified, the resistance modification factors associated with Condition A may be used.

6 Temperature range A: Max. short term temperature = 130°F (55°C), max. long term temperature = 110°F (43°C).

Temperature range B: Max. short term temperature = 176°F (80°C), max. long term temperature = 110°F (43°C).

Short term elevated concrete temperatures are those that occur over brief intervals, e.g., as a result of diurnal cycling. Long term concrete temperatures are roughly constant over significant periods of time.

7 Bond stress values corresponding to concrete compressive strength $f'_c = 2,500$ psi (17.2 MPa). For concrete compressive strength, f'_c , between 2,500 psi (17.2 MPa) and 8,000 psi (55.2 MPa), the tabulated characteristic bond stress may be increased by a factor of $(f'_c / 2,500)^{0.25}$ [for SI: $(f'_c / 17.2)^{0.25}$] for uncracked concrete.



Table 73 - Hilti HIT-RE 500 V3 adhesive factored resistance with concrete/bond failure for threaded rod in uncracked concrete^{1,2,3,4,5,6,7,8,9,11}

Nominal anchor diameter in.	Effective embedment in. (mm)	Tension N_t				Shear V_t			
		$f'_c = 20$ MPa (2,900 psi) lb (kN)	$f'_c = 25$ MPa (3,625 psi) lb (kN)	$f'_c = 30$ MPa (4,350 psi) lb (kN)	$f'_c = 40$ MPa (5,800 psi) lb (kN)	$f'_c = 20$ MPa (2,900 psi) lb (kN)	$f'_c = 25$ MPa (3,625 psi) lb (kN)	$f'_c = 30$ MPa (4,350 psi) lb (kN)	$f'_c = 40$ MPa (5,800 psi) lb (kN)
3/8	2-3/8 (60)	3,060 (13.6)	3,425 (15.2)	3,750 (16.7)	4,330 (19.3)	3,060 (13.6)	3,425 (15.2)	3,750 (16.7)	4,330 (19.3)
	3-3/8 (86)	5,185 (23.1)	5,800 (25.8)	6,355 (28.3)	7,335 (32.6)	10,375 (46.1)	11,600 (51.6)	12,705 (56.5)	14,670 (65.3)
	4-1/2 (114)	7,985 (35.5)	8,930 (39.7)	9,430 (41.9)	10,130 (45.1)	15,970 (71.0)	17,855 (79.4)	18,855 (83.9)	20,260 (90.1)
	7-1/2 (191)	14,200 (63.2)	15,010 (66.8)	15,715 (69.9)	16,885 (75.1)	28,395 (126.3)	30,025 (133.6)	31,425 (139.8)	33,770 (150.2)
1/2	2-3/4 (70)	3,815 (17.0)	4,265 (19.0)	4,670 (20.8)	5,395 (24.0)	7,630 (33.9)	8,530 (37.9)	9,345 (41.6)	10,790 (48.0)
	4-1/2 (114)	7,985 (35.5)	8,930 (39.7)	9,780 (43.5)	11,295 (50.2)	15,970 (71.0)	17,855 (79.4)	19,560 (87.0)	22,585 (100.5)
	6 (152)	12,295 (54.7)	13,745 (61.1)	15,060 (67.0)	17,385 (77.3)	24,590 (109.4)	27,490 (122.3)	30,115 (134.0)	34,775 (154.7)
	10 (254)	24,390 (108.5)	25,790 (114.7)	26,995 (120.1)	29,005 (129.0)	48,785 (217.0)	51,585 (229.5)	53,990 (240.2)	58,015 (258.1)
5/8 ¹⁰	3-1/8 (79)	4,620 (20.6)	5,165 (23.0)	5,660 (25.2)	6,535 (29.1)	9,245 (41.1)	10,335 (46.0)	11,320 (50.4)	13,070 (58.1)
	5-5/8 (143)	11,160 (49.6)	12,480 (55.5)	13,670 (60.8)	15,785 (70.2)	22,320 (99.3)	24,955 (111.0)	27,335 (121.6)	31,565 (140.4)
	7-1/2 (191)	17,185 (76.4)	19,210 (85.5)	21,045 (93.6)	24,300 (108.1)	34,365 (152.9)	38,420 (170.9)	42,090 (187.2)	48,600 (216.2)
	12-1/2 (318)	36,620 (162.9)	38,725 (172.2)	40,530 (180.3)	43,550 (193.7)	73,245 (325.8)	77,445 (344.5)	81,055 (360.6)	87,100 (387.4)
3/4 ¹⁰	3-1/2 (89)	5,480 (24.4)	6,125 (27.2)	6,710 (29.8)	7,745 (34.5)	10,955 (48.7)	12,250 (54.5)	13,420 (59.7)	15,495 (68.9)
	6-3/4 (171)	14,670 (65.3)	16,400 (73.0)	17,970 (79.9)	20,745 (92.3)	29,340 (130.5)	32,805 (145.9)	35,935 (159.8)	41,495 (184.6)
	9 (229)	22,585 (100.5)	25,255 (112.3)	27,665 (123.1)	31,945 (142.1)	45,175 (200.9)	50,505 (224.7)	55,325 (246.1)	63,885 (284.2)
	15 (381)	48,600 (216.2)	53,740 (239.1)	56,250 (250.2)	60,445 (268.9)	97,200 (432.4)	107,485 (478.1)	112,495 (500.4)	120,885 (537.7)
7/8 ¹⁰	3-1/2 (89)	5,480 (24.4)	6,125 (27.2)	6,710 (29.8)	7,745 (34.5)	10,955 (48.7)	12,250 (54.5)	13,420 (59.7)	15,495 (68.9)
	7-7/8 (200)	18,485 (82.2)	20,670 (91.9)	22,640 (100.7)	26,145 (116.3)	36,975 (164.5)	41,340 (183.9)	45,285 (201.4)	52,290 (232.6)
	10-1/2 (267)	28,465 (126.6)	31,820 (141.6)	34,860 (155.1)	40,255 (179.1)	56,925 (253.2)	63,645 (283.1)	69,720 (310.1)	80,505 (358.1)
	17-1/2 (445)	61,240 (272.4)	68,470 (304.6)	73,325 (326.2)	78,795 (350.5)	122,485 (544.8)	136,940 (609.1)	146,650 (652.3)	157,585 (701.0)
1 ¹⁰	4 (102)	6,690 (29.8)	7,480 (33.3)	8,195 (36.5)	9,465 (42.1)	13,385 (59.5)	14,965 (66.6)	16,395 (72.9)	18,930 (84.2)
	9 (229)	22,585 (100.5)	25,255 (112.3)	27,665 (123.1)	31,945 (142.1)	45,175 (200.9)	50,505 (224.7)	55,325 (246.1)	63,885 (284.2)
	12 (305)	34,775 (154.7)	38,880 (172.9)	42,590 (189.5)	49,180 (218.8)	69,550 (309.4)	77,760 (345.9)	85,180 (378.9)	98,360 (437.5)
	20 (508)	74,825 (332.8)	83,655 (372.1)	91,640 (407.6)	98,875 (439.8)	149,650 (665.7)	167,310 (744.2)	183,280 (815.3)	197,755 (879.7)
1-1/4 ¹⁰	5 (127)	9,355 (41.6)	10,455 (46.5)	11,455 (51.0)	13,225 (58.8)	18,705 (83.2)	20,915 (93.0)	22,910 (101.9)	26,455 (117.7)
	11-1/4 (286)	31,565 (140.4)	35,290 (157.0)	38,660 (172.0)	44,640 (198.6)	63,135 (280.8)	70,585 (314.0)	77,320 (343.9)	89,285 (397.1)
	15 (381)	48,600 (216.2)	54,335 (241.7)	59,520 (264.8)	68,730 (305.7)	97,200 (432.4)	108,670 (483.4)	119,045 (529.5)	137,460 (611.4)
	25 (635)	104,570 (465.1)	116,910 (520.0)	128,070 (569.7)	141,095 (627.6)	209,140 (930.3)	233,825 (1040.1)	256,140 (1139.4)	282,190 (1255.2)

3.2.3

- See Section 3.1.8 for explanation on development of load values.
- See Section 3.1.8 to convert design strength value to ASD value.
- Linear interpolation between embedment depths and concrete compressive strengths is not permitted.
- Apply spacing, edge distance, and concrete thickness factors in tables 30 - 41 as necessary to the above values. Compare to the steel values in table 29. The lesser of the values is to be used for the design.
- Data is for temperature range A: Max. short term temperature = 130°F (55°C), max. long term temperature = 110°F (43°C).
For temperature range B: Max. short term temperature = 176°F (80°C), max. long term temperature = 110°F (43°C) multiply above values by 0.69.
Short term elevated concrete temperatures are those that occur over brief intervals, e.g., as a result of diurnal cycling. Long term concrete temperatures are roughly constant over significant periods of time.
- Tabular values are for dry concrete or water-saturated concrete conditions.
For water-filled drilled holes multiply design strength by 0.51.
For submerged (under water) applications multiply design strength by 0.44.
- Tabular values are for short term loads only. For sustained loads including overhead use, see Section 3.1.8.
- Tabular values are for normal-weight concrete only. For lightweight concrete multiply design strength by λ_a as follows:
For sand-lightweight, $\lambda_a = 0.51$. For all-lightweight, $\lambda_a = 0.45$.
- Tabular values are for holes drilled in concrete with carbide tipped hammer drill bit. For diamond core drilling, except as indicated in note 10, multiply above values by 0.55.
Diamond core drilling is not permitted for the water-filled or under-water (submerged) applications.
- Diamond core drilling with Hilti TE-YRT roughening tool is permitted for 5/8", 3/4", 7/8", 1", and 1-1/4". See Table 76.
- Tabular values are for static loads only. Seismic design is not permitted for uncracked concrete.

Table 74 - Hilti HIT-RE 500 V3 adhesive factored resistance with concrete/bond failure for threaded rod in cracked concrete^{1,2,3,4,5,6,7,8,9,11}

Nominal anchor diameter in.	Effective embedment in. (mm)	Tension N_t				Shear V_r			
		$f'_c = 20$ MPa (2,900 psi) lb (kN)	$f'_c = 25$ MPa (3,625 psi) lb (kN)	$f'_c = 30$ MPa (4,350 psi) lb (kN)	$f'_c = 40$ MPa (5,800 psi) lb (kN)	$f'_c = 20$ MPa (2,900 psi) lb (kN)	$f'_c = 25$ MPa (3,625 psi) lb (kN)	$f'_c = 30$ MPa (4,350 psi) lb (kN)	$f'_c = 40$ MPa (5,800 psi) lb (kN)
3/8	2-3/8 (60)	2,145 (9.5)	2,395 (10.7)	2,530 (11.3)	2,645 (11.8)	2,145 (9.5)	2,395 (10.7)	2,530 (11.3)	2,645 (11.8)
	3-3/8 (86)	3,385 (15.1)	3,500 (15.6)	3,595 (16.0)	3,755 (16.7)	6,770 (30.1)	7,000 (31.1)	7,195 (32.0)	7,510 (33.4)
	4-1/2 (114)	4,515 (20.1)	4,665 (20.8)	4,795 (21.3)	5,005 (22.3)	9,025 (40.1)	9,335 (41.5)	9,590 (42.7)	10,015 (44.5)
	7-1/2 (191)	7,520 (33.5)	7,780 (34.6)	7,995 (35.6)	8,345 (37.1)	15,045 (66.9)	15,555 (69.2)	15,985 (71.1)	16,690 (74.2)
1/2	2-3/4 (70)	2,670 (11.9)	2,985 (13.3)	3,270 (14.5)	3,775 (16.8)	5,340 (23.8)	5,970 (26.6)	6,540 (29.1)	7,555 (33.6)
	4-1/2 (114)	5,590 (24.9)	6,175 (27.5)	6,345 (28.2)	6,625 (29.5)	11,180 (49.7)	12,345 (54.9)	12,690 (56.4)	13,250 (58.9)
	6 (152)	7,960 (35.4)	8,230 (36.6)	8,460 (37.6)	8,830 (39.3)	15,920 (70.8)	16,460 (73.2)	16,920 (75.3)	17,665 (78.6)
	10 (254)	13,265 (59.0)	13,720 (61.0)	14,100 (62.7)	14,720 (65.5)	26,535 (118.0)	27,435 (122.0)	28,200 (125.4)	29,440 (131.0)
5/8 ¹⁰	3-1/8 (79)	3,235 (14.4)	3,615 (16.1)	3,960 (17.6)	4,575 (20.4)	6,470 (28.8)	7,235 (32.2)	7,925 (35.2)	9,150 (40.7)
	5-5/8 (143)	7,810 (34.8)	8,735 (38.9)	9,570 (42.6)	10,270 (45.7)	15,625 (69.5)	17,470 (77.7)	19,135 (85.1)	20,540 (91.4)
	7-1/2 (191)	12,030 (53.5)	12,760 (56.8)	13,115 (58.3)	13,690 (60.9)	24,055 (107.0)	25,520 (113.5)	26,230 (116.7)	27,385 (121.8)
	12-1/2 (318)	20,565 (91.5)	21,265 (94.6)	21,855 (97.2)	22,820 (101.5)	41,135 (183.0)	42,535 (189.2)	43,715 (194.4)	45,640 (203.0)
3/4 ¹⁰	3-1/2 (89)	3,835 (17.1)	4,285 (19.1)	4,695 (20.9)	5,425 (24.1)	7,670 (34.1)	8,575 (38.1)	9,390 (41.8)	10,845 (48.2)
	6-3/4 (171)	10,270 (45.7)	11,480 (51.1)	12,575 (55.9)	14,525 (64.6)	20,540 (91.4)	22,965 (102.1)	25,155 (111.9)	29,045 (129.2)
	9 (229)	15,810 (70.3)	17,675 (78.6)	18,735 (83.3)	19,560 (87.0)	31,620 (140.7)	35,355 (157.3)	37,470 (166.7)	39,120 (174.0)
	15 (381)	29,380 (130.7)	30,380 (135.1)	31,225 (138.9)	32,600 (145.0)	58,760 (261.4)	60,760 (270.3)	62,445 (277.8)	65,200 (290.0)
7/8 ¹⁰	3-1/2 (89)	3,835 (17.1)	4,285 (19.1)	4,695 (20.9)	5,425 (24.1)	7,670 (34.1)	8,575 (38.1)	9,390 (41.8)	10,845 (48.2)
	7-7/8 (200)	12,940 (57.6)	14,470 (64.4)	15,850 (70.5)	18,300 (81.4)	25,880 (115.1)	28,935 (128.7)	31,700 (141.0)	36,605 (162.8)
	10-1/2 (267)	19,925 (88.6)	22,275 (99.1)	24,400 (108.5)	26,410 (117.5)	39,850 (177.3)	44,550 (198.2)	48,805 (217.1)	52,820 (235.0)
	17-1/2 (445)	39,670 (176.5)	41,020 (182.5)	42,160 (187.5)	44,020 (195.8)	79,340 (352.9)	82,040 (364.9)	84,315 (375.1)	88,035 (391.6)
1 ¹⁰	4 (102)	4,685 (20.8)	5,240 (23.3)	5,740 (25.5)	6,625 (29.5)	9,370 (41.7)	10,475 (46.6)	11,475 (51.0)	13,250 (58.9)
	9 (229)	15,810 (70.3)	17,675 (78.6)	19,365 (86.1)	22,360 (99.5)	31,620 (140.7)	35,355 (157.3)	38,730 (172.3)	44,720 (198.9)
	12 (305)	24,340 (108.3)	27,215 (121.1)	29,815 (132.6)	34,425 (153.1)	48,685 (216.6)	54,430 (242.1)	59,625 (265.2)	68,850 (306.3)
	20 (508)	51,815 (230.5)	53,580 (238.3)	55,065 (244.9)	57,490 (255.7)	103,630 (461.0)	107,155 (476.7)	110,130 (489.9)	114,985 (511.5)
1-1/4 ¹⁰	5 (127)	6,545 (29.1)	7,320 (32.6)	8,020 (35.7)	9,260 (41.2)	13,095 (58.2)	14,640 (65.1)	16,035 (71.3)	18,520 (82.4)
	11-1/4 (286)	22,095 (98.3)	24,705 (109.9)	27,060 (120.4)	31,250 (139.0)	44,195 (196.6)	49,410 (219.8)	54,125 (240.8)	62,500 (278.0)
	15 (381)	34,020 (151.3)	38,035 (169.2)	41,665 (185.3)	48,110 (214.0)	68,040 (302.7)	76,070 (338.4)	83,330 (370.7)	96,220 (428.0)
	25 (635)	73,200 (325.6)	79,665 (354.4)	81,875 (364.2)	85,485 (380.3)	146,395 (651.2)	159,330 (708.7)	163,750 (728.4)	170,970 (760.5)

1 See Section 3.1.8 for explanation on development of load values.
2 See Section 3.1.8 to convert design strength value to ASD value.
3 Linear interpolation between embedment depths and concrete compressive strengths is not permitted.
4 Apply spacing, edge distance, and concrete thickness factors in tables 30-41 as necessary to the above values. Compare to the steel values in table 29 to the above values. The lesser of the values is to be used for the design.
5 Data is for temperature range A: Max. short term temperature = 130°F (55°C), max. long term temperature = 110°F (43°C).
For temperature range B: Max. short term temperature = 176°F (80°C), max. long term temperature = 110°F (43°C) multiply above values by 0.69.
Short term elevated concrete temperatures are those that occur over brief intervals, e.g., as a result of diurnal cycling. Long term concrete temperatures are roughly constant over significant periods of time.
6 Tabular values are for dry or water saturated concrete conditions.
For water-filled drilled holes multiply design strength by 0.51.
For submerged (under water) applications multiply design strength by 0.44.
7 Tabular values are for short term loads only. For sustained loads including overhead use, see Section 3.1.8.
8 Tabular values are for normal-weight concrete only. For lightweight concrete multiply design strength by λ_s as follows:
For sand-lightweight, $\lambda_s = 0.51$. For all-lightweight, $\lambda_s = 0.45$.
9 Tabular values are for holes drilled in concrete with carbide tipped hammer drill bit. Diamond core drilling is not permitted in cracked concrete except as indicated in note 10.
10 Diamond core drilling with Hilti TE-YRT roughening tool is permitted for 5/8", 3/4", 7/8", 1", and 1-1/4". See Table 77.
11 Tabular values are for static loads only. For seismic loads, multiply cracked concrete tabular values by α_{seis} indicated below. See section 3.1.8 for additional information on seismic applications.
3/8-in. diameter - $\alpha_{seis} = 0.69$
1/2-in. diameter - $\alpha_{seis} = 0.70$
5/8-in. diameter - $\alpha_{seis} = 0.71$
3/4-in. diameter and larger - $\alpha_{seis} = 0.75$



Table 75 - Steel factored resistance for Hilti HAS threaded rods for use with CSA A23.3-14 Annex D

Nominal anchor diameter in.	HAS-V-36 / HAS-V-36 HDG ASTM F1554 Gr.36 ^{4,6}			HAS-E-55 / HAS-E-55 HDG ASTM F1554 Gr. 55 ^{4,5,6}			HAS-B-105 / HAS-B-105 HDG ASTM A193 B7 and ASTM F 1554 Gr.105 ^{4,6}			HAS-R stainless steel ASTM F593 (3/8-in to 1-in) ⁵ ASTM A193 (1-1/8-in to 2-in) ⁴		
	Tensile ¹ ΦN _{bar} lb (kN)	Shear ² ΦV _{bar} lb (kN)	Seismic Shear ³ ΦV _{bar,eq} lb (kN)	Tensile ¹ ΦN _{bar} lb (kN)	Shear ² ΦV _{bar} lb (kN)	Seismic Shear ³ ΦV _{bar,eq} lb (kN)	Tensile ¹ ΦN _{bar} lb (kN)	Shear ² ΦV _{bar} lb (kN)	Seismic Shear ³ ΦV _{bar,eq} lb (kN)	Tensile ¹ ΦN _{bar} lb (kN)	Shear ² ΦV _{bar} lb (kN)	Seismic Shear ³ ΦV _{bar,eq} lb (kN)
3/8	3,055 (13.6)	1,720 (7.7)	1,030 (4.6)	3,955 (17.6)	2,225 (9.9)	2,225 (9.9)	6,570 (29.2)	3,695 (16.4)	3,695 (16.4)	4,610 (20.5)	2,570 (11.4)	2,055 (9.1)
1/2	5,595 (24.9)	3,150 (14.0)	1,890 (8.4)	7,240 (32.2)	4,070 (18.1)	4,070 (18.1)	12,035 (53.5)	6,765 (30.1)	6,765 (30.1)	8,445 (37.6)	4,705 (20.9)	3,765 (16.7)
5/8	8,915 (39.7)	5,015 (22.3)	3,010 (13.4)	11,525 (51.3)	6,485 (28.8)	6,485 (28.8)	19,160 (85.2)	10,780 (48.0)	10,780 (48.0)	13,445 (59.8)	7,490 (33.3)	5,990 (26.6)
3/4	13,190 (58.7)	7,420 (33.0)	4,450 (19.8)	17,060 (75.9)	9,600 (42.7)	9,600 (42.7)	28,365 (126.2)	15,955 (71.0)	15,955 (71.0)	16,920 (75.3)	9,425 (41.9)	7,540 (33.5)
7/8	18,210 (81.0)	10,245 (45.6)	6,145 (27.3)	23,550 (104.8)	13,245 (58.9)	13,245 (58.9)	39,150 (174.1)	22,020 (97.9)	22,020 (97.9)	23,350 (103.9)	13,010 (57.9)	10,410 (46.3)
1	23,890 (106.3)	13,440 (59.8)	8,065 (35.9)	30,890 (137.4)	17,380 (77.3)	17,380 (77.3)	51,360 (228.5)	28,890 (128.5)	28,890 (128.5)	30,635 (136.3)	17,065 (75.9)	13,650 (60.7)
1-1/4	38,225 (170.0)	21,500 (95.6)	12,900 (57.4)	49,425 (219.9)	27,800 (123.7)	27,800 (123.7)	82,175 (365.5)	46,220 (205.6)	46,220 (205.6)	37,565 (167.1)	21,130 (94.0)	16,905 (75.2)

- 1 Tensile = $\phi A_{se,N} f_{uta} R$ as noted in CSA A23.3-14 Eq. D.2.
- 2 Shear = $\phi 0.60 A_{se,V} f_{uta} R$ as noted in CSA A23.3-14 Eq. D.31.
- 3 Seismic Shear = $\alpha_{N,seis} V_{bar}$: Reduction factor for seismic shear only. See CSA A23.3 Annex D for additional information on seismic applications. Seismic shear for HIT-RE 500 V3
- 4 HAS-V, HAS-E (3/8-in to 1-1/4-in), HAS-B, and HAS-R (Class 1; 1-1/4-in) threaded rods are considered ductile steel elements (including HDG rods).
- 5 HAS-R (CW1 and CW2; 3/8-in to 1-in) threaded rods are considered brittle steel elements.
- 6 3/8-inch dia. threaded rods are not included in the ASTM F1554 standard. Hilti 3/8-inch dia. HAS-V, HAS-E, and HAS-E-B (incl. HDG) threaded rods meet the chemical composition and mechanical property requirements of ASTM F1554.

Table 75 - Hilti HIT-RE 500-V3 design information with HAS threaded rods in core drilled holes roughened with the TE-YRT Roughening Tool in accordance with CSA A23.3-14 Annex D^{1,8}



3.2.3

Design parameter	Symbol	Units	Nominal rod diameter (in.)					Ref A23.3-14	
			5/8	3/4	7/8	1	1-1/4		
Nominal anchor diameter	d_a	mm	15.9	19.1	22.2	25.4	31.8		
Effective minimum embedment ²	h_{ef}	mm	79	89	89	102	127		
Effective maximum embedment ²	h_{ef}	mm	318	286	445	508	635		
Minimum concrete thickness ²	h_{min}	mm	$h_{ef} + 2d_o$						
Critical edge distance	c_{ec}	-	$2h_{ef}$						
Minimum edge distance	c_{min}^3	mm	79	95	111	127	159		
Minimum anchor spacing	s_{min}	mm	79	95	111	127	159		
Coeff. for factored concrete breakout resistance, uncracked concrete	$k_{c,uncr}^4$	-	10					D.6.2.2	
Coeff. for factored concrete breakout resistance, cracked concrete	$k_{c,cr}^4$	-	7					D.6.2.2	
Concrete material resistance factor	ϕ_s	-	0.65					8.4.2	
Resistance modification factor for tension and shear, concrete failure modes, Condition B ⁵	R_{conc}	-	1.00					D.5.3(c)	
Dry and water saturated concrete									
Temp. range A ⁶	Characteristic bond stress in cracked concrete ^{6,7}	τ_{cr}	psi (MPa)	880 (6.1)	875 (6.0)	870 (6.0)	870 (6.0)	825 (5.7)	D.6.5.2
	Characteristic bond stress in uncracked concrete ^{6,7}	τ_{uncr}	psi (MPa)	2,210 (15.2)	2,130 (14.7)	2,040 (14.1)	1,960 (13.5)	1,790 (12.3)	D.6.5.2
Temp. range B ⁶	Characteristic bond stress in cracked concrete ^{6,7}	τ_{cr}	psi (MPa)	610 (4.2)	605 (4.2)	605 (4.2)	600 (4.1)	570 (3.9)	D.6.5.2
	Characteristic bond stress in uncracked concrete ^{6,7}	τ_{uncr}	psi (MPa)	1,530 (10.6)	1,470 (10.1)	1,410 (9.7)	1,350 (9.3)	1,240 (8.6)	D.6.5.2
Anchor category, dry concrete	-	-	1	1	1	1	1		
Resistance modification factor	R_{dry}	-	1.00	1.00	1.00	1.00	1.00		
Reduction for seismic tension	$\alpha_{N,seis}$	-	0.95	1.00	1.00	1.00	1.00		

- 1 Design information in this table is taken from ICC-ES ELC-3814, dated April 2018, table 11 and 12, and converted for use with CSA A23.3-14 Annex D.
- 2 See figure 8 of section 3.2.4.3.4.
- 3 Minimum edge distance may be reduced to $45\text{mm} \leq c_{gr} < 5d$ provided T_{inst} is reduced. See ESR-3814 section 4.1.9.
- 4 For all design cases, $\psi_{c,N} = 1.0$. The appropriate coefficient for breakout resistance for cracked concrete ($k_{c,cr}$) or uncracked concrete ($k_{c,uncr}$) must be used.
- 5 For use with the load combinations of CSA A23.3-14 chapter 8. Condition B applies where supplementary reinforcement in conformance with CSA A23.3-14 section D.5.3 is not provided, or where pullout or pryout strength governs. For cases where the presence of supplementary reinforcement can be verified, the resistance modification factors associated with Condition A may be used.
- 6 Temperature range A: Max. short term temperature = 130°F (55°C), max. long term temperature = 110°F (43°C).
Temperature range B: Max. short term temperature = 176°F (80°C), max. long term temperature = 110°F (43°C).
Short term elevated concrete temperatures are those that occur over brief intervals, e.g., as a result of diurnal cycling. Long term concrete temperatures are roughly constant over significant periods of time.
- 7 Bond stress values correspond to concrete compressive strength in the range $2,500 \text{ psi} \leq f'_c \leq 8,000 \text{ psi}$.
- 8 For structures assigned to Seismic Design Categories C, D, E, or F, bond stress values must be multiplied by $\alpha_{N,seis}$.

Table 76 - Hilti HIT-RE 500 V3 Core Drilled and roughened with TE-YRT Roughening Tool adhesive factored resistance with concrete / bond failure for threaded rod in uncracked concrete^{1,2,3,4,5,6,7,8,9}

Nominal anchor diameter in.	Effective embedment in. (mm)	Tension N_t				Shear V_r			
		$f'_c = 20$ MPa (2,900 psi) lb (kN)	$f'_c = 25$ MPa (3,625 psi) lb (kN)	$f'_c = 30$ MPa (4,350 psi) lb (kN)	$f'_c = 40$ MPa (5,800 psi) lb (kN)	$f'_c = 20$ MPa (2,900 psi) lb (kN)	$f'_c = 25$ MPa (3,625 psi) lb (kN)	$f'_c = 30$ MPa (4,350 psi) lb (kN)	$f'_c = 40$ MPa (5,800 psi) lb (kN)
5/8	3-1/8 (79)	4,620 (20.6)	5,165 (23.0)	5,660 (25.2)	6,535 (29.1)	9,245 (41.1)	10,335 (46.0)	11,320 (50.4)	13,070 (58.1)
	5-5/8 (143)	11,160 (49.6)	12,480 (55.5)	13,670 (60.8)	15,785 (70.2)	22,320 (99.3)	24,955 (111.0)	27,335 (121.6)	31,565 (140.4)
	7-1/2 (191)	17,185 (76.4)	19,210 (85.5)	21,045 (93.6)	21,160 (94.1)	34,365 (152.9)	38,420 (170.9)	42,090 (187.2)	42,320 (188.2)
	12-1/2 (318)	35,265 (156.9)	35,265 (156.9)	35,265 (156.9)	35,265 (156.9)	70,535 (313.7)	70,535 (313.7)	70,535 (313.7)	70,535 (313.7)
3/4	3-1/2 (89)	5,480 (24.4)	6,125 (27.2)	6,710 (29.8)	7,745 (34.5)	10,955 (48.7)	12,250 (54.5)	13,420 (59.7)	15,495 (68.9)
	6-3/4 (171)	14,670 (65.3)	16,400 (73.0)	17,970 (79.9)	20,745 (92.3)	29,340 (130.5)	32,805 (145.9)	35,935 (159.8)	41,495 (184.6)
	9 (229)	22,585 (100.5)	25,255 (112.3)	27,665 (123.1)	29,365 (130.6)	45,175 (200.9)	50,505 (224.7)	55,325 (246.1)	58,735 (261.3)
	11-1/4 (286)	31,565 (140.4)	35,290 (157.0)	36,710 (163.3)	36,710 (163.3)	63,135 (280.8)	70,585 (314.0)	73,420 (326.6)	73,420 (326.6)
7/8	3-1/2 (89)	5,480 (24.4)	6,125 (27.2)	6,710 (29.8)	7,745 (34.5)	10,955 (48.7)	12,250 (54.5)	13,420 (59.7)	15,495 (68.9)
	7-7/8 (200)	18,485 (82.2)	20,670 (91.9)	22,640 (100.7)	26,145 (116.3)	36,975 (164.5)	41,340 (183.9)	45,285 (201.4)	52,290 (232.6)
	10-1/2 (267)	28,465 (126.6)	31,820 (141.6)	34,860 (155.1)	38,285 (170.3)	56,925 (253.2)	63,645 (283.1)	69,720 (310.1)	76,565 (340.6)
	17-1/2 (445)	61,240 (272.4)	63,805 (283.8)	63,805 (283.8)	63,805 (283.8)	122,485 (544.8)	127,610 (567.6)	127,610 (567.6)	127,610 (567.6)
1	4 (102)	6,690 (29.8)	7,480 (33.3)	8,195 (36.5)	9,465 (42.1)	13,385 (59.5)	14,965 (66.6)	16,395 (72.9)	18,930 (84.2)
	9 (229)	22,585 (100.5)	25,255 (112.3)	27,665 (123.1)	31,945 (142.1)	45,175 (200.9)	50,505 (224.7)	55,325 (246.1)	63,885 (284.2)
	12 (305)	34,775 (154.7)	38,880 (172.9)	42,590 (189.5)	48,040 (213.7)	69,550 (309.4)	77,760 (345.9)	85,180 (378.9)	96,085 (427.4)
	20 (508)	74,825 (332.8)	80,070 (356.2)	80,070 (356.2)	80,070 (356.2)	149,650 (665.7)	160,140 (712.3)	160,140 (712.3)	160,140 (712.3)
1-1/4	5 (127)	9,355 (41.6)	10,455 (46.5)	11,455 (51.0)	13,225 (58.8)	18,705 (83.2)	20,915 (93.0)	22,910 (101.9)	26,455 (117.7)
	11-1/4 (286)	31,565 (140.4)	35,290 (157.0)	38,660 (172.0)	44,640 (198.6)	63,135 (280.8)	70,585 (314.0)	77,320 (343.9)	89,285 (397.1)
	15 (381)	48,600 (216.2)	54,335 (241.7)	59,520 (264.8)	68,555 (304.9)	97,200 (432.4)	108,670 (483.4)	119,045 (529.5)	137,110 (609.9)
	25 (635)	104,570 (465.1)	114,255 (508.2)	114,255 (508.2)	114,255 (508.2)	209,140 (930.3)	228,515 (1016.5)	228,515 (1016.5)	228,515 (1016.5)

- 1 See Section 3.1.8 for explanation on development of load values.
- 2 See Section 3.1.8 to convert design strength value to ASD value.
- 3 Linear interpolation between embedment depths and concrete compressive strengths is not permitted.
- 4 Apply spacing, edge distance, and concrete thickness factors in tables 30 - 41 as necessary to the above values. Compare to the steel values in table 29. The lesser of the values is to be used for the design.
- 5 Data is for temperature range A: Max. short term temperature = 130°F (55°C), max. long term temperature = 110°F (43°C).
For temperature range B: Max. short term temperature = 176°F (80°C), max. long term temperature = 110°F (43°C) multiply above values by 0.69.
Short term elevated concrete temperatures are those that occur over brief intervals, e.g., as a result of diurnal cycling. Long term concrete temperatures are roughly constant over significant periods of time.
- 6 Tabular values are for dry concrete or water-saturated concrete conditions. Water-filled and submerged (under water) applications are not permitted for this hole preparation method.
- 7 Tabular values are for short term loads only. For sustained loads including overhead use, see Section 3.1.8.
- 8 Tabular values are for normal-weight concrete only. For lightweight concrete multiply design strength by λ_a as follows:
For sand-lightweight, $\lambda_a = 0.51$. For all-lightweight, $\lambda_a = 0.45$.
- 9 Tabular values are for static loads only. Seismic design is not permitted for uncracked concrete.



Table 77 - Hilti HIT-RE 500 V3 Core Drilled and roughened with TE-YRT Roughening Tool adhesive factored resistance with concrete / bond failure for threaded rod in cracked concrete^{1,2,3,4,5,6,7,8,9}

Nominal anchor diameter in.	Effective embedment in. (mm)	Tension N_t				Shear V_t			
		$f'_c = 20$ MPa (2,900 psi) lb (kN)	$f'_c = 25$ MPa (3,625 psi) lb (kN)	$f'_c = 30$ MPa (4,350 psi) lb (kN)	$f'_c = 40$ MPa (5,800 psi) lb (kN)	$f'_c = 20$ MPa (2,900 psi) lb (kN)	$f'_c = 25$ MPa (3,625 psi) lb (kN)	$f'_c = 30$ MPa (4,350 psi) lb (kN)	$f'_c = 40$ MPa (5,800 psi) lb (kN)
5/8	3-1/8 (79)	3,235 (14.4)	3,510 (15.6)	3,510 (15.6)	3,510 (15.6)	6,470 (28.8)	7,020 (31.2)	7,020 (31.2)	7,020 (31.2)
	5-5/8 (143)	6,320 (28.1)	6,320 (28.1)	6,320 (28.1)	6,320 (28.1)	12,640 (56.2)	12,640 (56.2)	12,640 (56.2)	12,640 (56.2)
	7-1/2 (191)	8,425 (37.5)	8,425 (37.5)	8,425 (37.5)	8,425 (37.5)	16,850 (75.0)	16,850 (75.0)	16,850 (75.0)	16,850 (75.0)
	12-1/2 (318)	14,045 (62.5)	14,045 (62.5)	14,045 (62.5)	14,045 (62.5)	28,085 (124.9)	28,085 (124.9)	28,085 (124.9)	28,085 (124.9)
3/4	3-1/2 (89)	3,835 (17.1)	4,285 (19.1)	4,690 (20.9)	4,690 (20.9)	7,670 (34.1)	8,575 (38.1)	9,385 (41.7)	9,385 (41.7)
	6-3/4 (171)	9,050 (40.2)	9,050 (40.2)	9,050 (40.2)	9,050 (40.2)	18,095 (80.5)	18,095 (80.5)	18,095 (80.5)	18,095 (80.5)
	9 (229)	12,065 (53.7)	12,065 (53.7)	12,065 (53.7)	12,065 (53.7)	24,130 (107.3)	24,130 (107.3)	24,130 (107.3)	24,130 (107.3)
	11-1/4 (286)	15,080 (67.1)	15,080 (67.1)	15,080 (67.1)	15,080 (67.1)	30,160 (134.2)	30,160 (134.2)	30,160 (134.2)	30,160 (134.2)
7/8	3-1/2 (89)	3,835 (17.1)	4,285 (19.1)	4,695 (20.9)	5,425 (24.1)	7,670 (34.1)	8,575 (38.1)	9,390 (41.8)	10,845 (48.2)
	7-7/8 (200)	12,245 (54.5)	12,245 (54.5)	12,245 (54.5)	12,245 (54.5)	24,490 (108.9)	24,490 (108.9)	24,490 (108.9)	24,490 (108.9)
	10-1/2 (267)	16,325 (72.6)	16,325 (72.6)	16,325 (72.6)	16,325 (72.6)	32,655 (145.2)	32,655 (145.2)	32,655 (145.2)	32,655 (145.2)
	17-1/2 (445)	27,210 (121.0)	27,210 (121.0)	27,210 (121.0)	27,210 (121.0)	54,420 (242.1)	54,420 (242.1)	54,420 (242.1)	54,420 (242.1)
1	4 (102)	4,685 (20.8)	5,240 (23.3)	5,740 (25.5)	6,625 (29.5)	9,370 (41.7)	10,475 (46.6)	11,475 (51.0)	13,250 (58.9)
	9 (229)	15,810 (70.3)	15,995 (71.1)	15,995 (71.1)	15,995 (71.1)	31,620 (140.7)	31,985 (142.3)	31,985 (142.3)	31,985 (142.3)
	12 (305)	21,325 (94.9)	21,325 (94.9)	21,325 (94.9)	21,325 (94.9)	42,650 (189.7)	42,650 (189.7)	42,650 (189.7)	42,650 (189.7)
	20 (508)	35,540 (158.1)	35,540 (158.1)	35,540 (158.1)	35,540 (158.1)	71,080 (316.2)	71,080 (316.2)	71,080 (316.2)	71,080 (316.2)
1-1/4	5 (127)	6,545 (29.1)	7,320 (32.6)	8,020 (35.7)	9,260 (41.2)	13,095 (58.2)	14,640 (65.1)	16,035 (71.3)	18,520 (82.4)
	11-1/4 (286)	22,095 (98.3)	23,695 (105.4)	23,695 (105.4)	23,695 (105.4)	44,195 (196.6)	47,395 (210.8)	47,395 (210.8)	47,395 (210.8)
	15 (381)	31,595 (140.5)	31,595 (140.5)	31,595 (140.5)	31,595 (140.5)	63,190 (281.1)	63,190 (281.1)	63,190 (281.1)	63,190 (281.1)
	25 (635)	52,660 (234.2)	52,660 (234.2)	52,660 (234.2)	52,660 (234.2)	105,320 (468.5)	105,320 (468.5)	105,320 (468.5)	105,320 (468.5)

3.2.3

- See Section 3.1.8 for explanation on development of load values.
- See Section 3.1.8 to convert design strength value to ASD value.
- Linear interpolation between embedment depths and concrete compressive strengths is not permitted.
- Apply spacing, edge distance, and concrete thickness factors in tables 30 - 41 as necessary to the above values. Compare to the steel values in table 29. The lesser of the values is to be used for the design.
- Data is for temperature range A: Max. short term temperature = 130°F (55°C), max. long term temperature = 110°F (43°C).
For temperature range B: Max. short term temperature = 176°F (80°C), max. long term temperature = 110°F (43°C) multiply above values by 0.69. Short term elevated concrete temperatures are those that occur over brief intervals, e.g., as a result of diurnal cycling. Long term concrete temperatures are roughly constant over significant periods of time.
- Tabular values are for dry concrete or water-saturated concrete conditions. Water-filled and submerged (under water) applications are not permitted for this hole preparation method.
Tabular values are for short term loads only. For sustained loads including overhead use, see Section 3.1.8.
- Tabular values are for normal-weight concrete only. For lightweight concrete multiply design strength by λ_a as follows:
For sand-lightweight, $\lambda_a = 0.51$. For all-lightweight, $\lambda_a = 0.45$.
- Tabular values are for static loads only. For seismic loads, multiply cracked concrete tabular values by α_{seis} indicated below. See section 3.1.8 for additional information on seismic applications.
5/8-in. diameter $\alpha_{seis} = 0.71$
3/4-in. diameter and larger - $\alpha_{seis} = 0.75$

HIT-RE 500 V3 adhesive with HIS-(R)N Inserts



Table 78 - Hilti HIT-RE 500 V3 design information with Hilti HIS-N and HIS-RN internally threaded inserts in hammer drilled holes in accordance with CSA A23.3-14 Annex D^{1,7}



Design parameter	Symbol	Units	Nominal bolt/cap screw diameter (in.)				Ref	
			3/8	1/2	5/8	3/4		
HIS insert outside diameter	D	mm	16.5	20.5	25.4	27.6	A23.3-14	
Effective embedment ²	h_{ef}	mm	110	125	170	205		
Min. concrete thickness ²	h_{min}	mm	150	170	230	270		
Critical edge distance	c_{ac}	-	$2h_{ef}$					
Minimum edge distance	c_{min}	mm	83	102	127	140		
Minimum anchor spacing	s_{min}	mm	83	102	127	140		
Coeff. for factored conc. breakout resistance, uncracked concrete	$k_{c,uncr}$ ³	-	10				D.6.2.2	
Coeff. for factored conc. breakout resistance, cracked concrete	$k_{c,cr}$ ³	-	7				D.6.2.2	
Concrete material resistance factor	ϕ_c	-	0.65				8.4.2	
Resistance modification factor for tension and shear, concrete failure modes, Condition B ⁵	R_{conc}	-	1.00				D.5.3(c)	
Dry and water saturated concrete								
Temp. range A ⁵	Characteristic bond stress in cracked concrete ^{6,7}	τ_{cr}	psi (MPa)	1,070 (7.4)	1,070 (7.4)	1,070 (7.4)	1,070 (7.4)	D.6.5.2
	Characteristic bond stress in uncracked concrete ^{6,7}	τ_{uncr}	psi (MPa)	1,790 (12.3)	1,790 (12.3)	1,790 (12.3)	1,790 (12.3)	D.6.5.2
Temp. range B ⁵	Characteristic bond stress in cracked concrete ^{6,7}	τ_{cr}	psi (MPa)	740 (5.1)	740 (5.1)	740 (5.1)	740 (5.1)	D.6.5.2
	Characteristic bond stress in uncracked concrete ^{6,7}	τ_{uncr}	psi (MPa)	1,240 (8.6)	1,240 (8.6)	1,240 (8.6)	1,240 (8.6)	D.6.5.2
Anchor category, dry concrete		-	-	1	1	1	1	
Resistance modification factor		R_{dry}	-	1.00	1.00	1.00	1.00	
Water-filled hole								
Temp. range A ⁵	Characteristic bond stress in cracked concrete ^{6,7}	τ_{cr}	psi (MPa)	800 (5.5)	810 (5.6)	820 (5.7)	820 (5.7)	D.6.5.2
	Characteristic bond stress in uncracked concrete ^{6,7}	τ_{uncr}	psi (MPa)	1,340 (9.2)	1,350 (9.3)	1,370 (9.4)	1,380 (9.5)	D.6.5.2
Temp. range B ⁵	Characteristic bond stress in cracked concrete ^{6,7}	τ_{cr}	psi (MPa)	550 (3.8)	560 (3.9)	570 (3.9)	570 (3.9)	D.6.5.2
	Characteristic bond stress in uncracked concrete ^{6,7}	τ_{uncr}	psi (MPa)	920 (6.3)	930 (6.4)	950 (6.6)	950 (6.6)	D.6.5.2
Anchor category, water-filled hole		-	-	3	3	3	3	
Resistance modification factor		R_{wf}	-	0.75	0.75	0.75	0.75	
Underwater applications								
Temp. range A ⁵	Characteristic bond stress in cracked concrete ^{6,7}	τ_{cr}	psi (MPa)	710 (4.9)	720 (5.0)	750 (5.2)	750 (5.2)	D.6.5.2
	Characteristic bond stress in uncracked concrete ^{6,7}	τ_{uncr}	psi (MPa)	1,190 (8.2)	1,210 (8.3)	1,250 (8.6)	1,260 (8.7)	D.6.5.2
Temp. range B ⁵	Characteristic bond stress in cracked concrete ^{6,7}	τ_{cr}	psi (MPa)	490 (3.4)	500 (3.4)	510 (3.5)	520 (3.6)	D.6.5.2
	Characteristic bond stress in uncracked concrete ^{6,7}	τ_{uncr}	psi (MPa)	820 (5.7)	840 (5.8)	860 (5.9)	870 (6.0)	D.6.5.2
Anchor category, underwater		-	-	3	3	3	3	
Resistance modification factor		R_{uw}	-	0.75	0.75	0.75	0.75	
Reduction for seismic tension		$\alpha_{N,seis}$	-	1.00	1.00	1.00	1.00	

- Design information in this table is taken from ICC-ES ELC-3814, dated April 2018, tables 16 and 17, and converted for use with CSA A23.3-14 Annex D.
- See figure 3 of this section.
- For all design cases, $\psi_{c,N} = 1.0$. The appropriate coefficient for breakout resistance for cracked concrete ($k_{c,cr}$) or uncracked concrete ($k_{c,uncr}$) must be used.
- For use with the load combinations of CSA A23.3-14 chapter 8. Condition B applies where supplementary reinforcement in conformance with CSA A23.3-14 section D.5.3 is not provided, or where pullout or pryout strength governs. For cases where the presence of supplementary reinforcement can be verified, the resistance modification factors associated with Condition A may be used.
- Temperature range A: Max. short term temperature = 130°F (55°C), max. long term temperature = 110°F (43°C).
Temperature range B: Max. short term temperature = 176°F (80°C), max. long term temperature = 110°F (43°C).
Short term elevated concrete temperatures are those that occur over brief intervals, e.g., as a result of diurnal cycling. Long term concrete temperatures are roughly constant over significant periods of time.
- Bond stress values corresponding to concrete compressive strength $f'_c = 2,500$ psi (17.2 MPa). For concrete compressive strength, f'_c between 2,500 psi (17.2 MPa) and 8,000 psi (55.2 MPa), the tabulated characteristic bond stress may be increased by a factor of $(f'_c/2,500)^{0.25}$ [for SI: $(f'_c/17.2)^{0.25}$]. for uncracked concrete and $(f'_c/2,500)^{0.15}$ [for SI: $(f'_c/17.2)^{0.15}$] for cracked concrete
- For structures assigned to Seismic Design Categories C, D, E, or F, bond stress values must be multiplied by $\alpha_{N,seis}$.



Table 79 - Hilti HIT-RE 500 V3 design information with Hilti HIS-N and HIS-RN internally threaded inserts in diamond core drilled holes in accordance with CSA A23.3-14 Annex D¹

Design parameter	Symbol	Units	Nominal bolt/cap screw diameter (in.)				Ref	
			3/8	1/2	5/8	3/4		
HIS insert outside diameter	D	mm	16.5	20.5	25.4	27.6	A23.3-14	
Effective embedment ²	h_{ef}	mm	110	125	170	205		
Min. concrete thickness ²	h_{min}	mm	150	170	230	270		
Critical edge distance	c_{ac}	-	$2h_{ef}$					
Minimum edge distance	c_{min}	mm	83	102	127	140		
Minimum anchor spacing	s_{min}	mm	83	102	127	140		
Coeff. for factored conc. breakout resistance, uncracked concrete	$k_{c,unscr}^3$	-	10				D.6.2.2	
Coeff. for factored conc. breakout resistance, cracked concrete	$k_{c,scr}^3$	-	7				D.6.2.2	
Concrete material resistance factor	ϕ_c	-	0.65				8.4.2	
Resistance modification factor for tension and shear, concrete failure modes, Condition B ⁵	R_{conc}	-	1.00				D.5.3(c)	
Dry concrete								
Temp. range A ⁶	Characteristic bond stress in uncracked concrete ^{6,7}	τ_{cr}	psi (MPa)	1,200 (8.3)	1,200 (8.3)	1,200 (8.3)	1,200 (8.3)	D.6.5.2
Temp. range B ⁶	Characteristic bond stress in uncracked concrete ^{6,7}	τ_{cr}	psi (MPa)	830 (5.7)	830 (5.7)	830 (5.7)	830 (5.7)	D.6.5.2
Anchor category, dry concrete			-	3	3	3	3	
Resistance modification factor			R_{dry}	0.75	0.75	0.75	0.75	
Water saturated hole								
Temp. range A ⁶	Characteristic bond stress in uncracked concrete ^{6,7}	τ_{cr}	psi (MPa)	1,200 (8.3)	1,200 (8.3)	1,200 (8.3)	1,200 (8.3)	D.6.5.2
Temp. range B ⁶	Characteristic bond stress in uncracked concrete ^{6,7}	τ_{cr}	psi (MPa)	830 (5.7)	830 (5.7)	830 (5.7)	830 (5.7)	D.6.5.2
Anchor category, water-saturated conc.			-	3	3	3	3	
Resistance modification factor			R_{wet}	0.75	0.75	0.75	0.75	

- Design information in this table is taken from ICC-ES ELC-3814, dated April 2018, tables 16 and 17, and converted for use with CSA A23.3-14 Annex D.
- See figure 8 of section 3.2.4.3.6.
- For all design cases, $\psi_{e,N} = 1.0$. The appropriate coefficient for breakout resistance for cracked concrete ($k_{c,scr}$) or uncracked concrete ($k_{c,unscr}$) must be used.
- For use with the load combinations of CSA A23.3-14 chapter 8. Condition B applies where supplementary reinforcement in conformance with CSA A23.3-14 section D.5.3 is not provided, or where pullout or pryout strength governs. For cases where the presence of supplementary reinforcement can be verified, the resistance modification factors associated with Condition A may be used.
- Temperature range A: Max. short term temperature = 130°F (55°C), max. long term temperature = 110°F (43°C).
Temperature range B: Max. short term temperature = 176°F (80°C), max. long term temperature = 110°F (43°C).
Short term elevated concrete temperatures are those that occur over brief intervals, e.g., as a result of diurnal cycling. Long term concrete temperatures are roughly constant over significant periods of time.
- Bond stress values corresponding to concrete compressive strength $f'_c = 2,500$ psi (17.2 MPa). For concrete compressive strength, f'_c between 2,500 psi (17.2 MPa) and 8,000 psi (55.2 MPa), the tabulated characteristic bond stress may be increased by a factor of $(f'_c/2,500)^{0.25}$ [for SI: $(f'_c/17.2)^{0.25}$] for uncracked concrete.

3.2.3

Table 80 - Hilti HIT-RE 500 V3 adhesive factored resistance with concrete / bond failure for Hilti HIS-N and HIS-RN internally threaded inserts in uncracked concrete^{1,2,3,4,5,6,7,8,9,11}



Thread size	Effective embedment in. (mm)	Tension N_t				Shear V_r			
		$f'_c = 20$ MPa (2,900 psi) lb (kN)	$f'_c = 25$ MPa (3,625 psi) lb (kN)	$f'_c = 30$ MPa (4,350 psi) lb (kN)	$f'_c = 40$ MPa (5,800 psi) lb (kN)	$f'_c = 20$ MPa (2,900 psi) lb (kN)	$f'_c = 25$ MPa (3,625 psi) lb (kN)	$f'_c = 30$ MPa (4,350 psi) lb (kN)	$f'_c = 40$ MPa (5,800 psi) lb (kN)
3/8-16 UNC	4-3/8 (110)	7,540 (33.5)	8,430 (37.5)	9,235 (41.1)	10,660 (47.4)	15,080 (67.1)	16,860 (75.0)	18,470 (82.1)	21,325 (94.9)
1/2-13 UNC ¹⁰	5 (125)	9,135 (40.6)	10,210 (45.4)	11,185 (49.8)	12,915 (57.5)	18,265 (81.3)	20,420 (90.8)	22,370 (99.5)	25,830 (114.9)
5/8-11 UNC ¹⁰	6-3/4 (170)	14,485 (64.4)	16,195 (72.0)	17,740 (78.9)	20,485 (91.1)	28,970 (128.9)	32,390 (144.1)	35,480 (157.8)	40,970 (182.2)
3/4-10 UNC ¹⁰	8-1/8 (205)	19,180 (85.3)	21,445 (95.4)	23,490 (104.5)	27,125 (120.7)	38,360 (170.6)	42,890 (190.8)	46,985 (209.0)	54,255 (241.3)

- See Section 3.1.8 for explanation on development of load values.
- See Section 3.1.8 to convert design strength value to ASD value.
- Linear interpolation between embedment depths and concrete compressive strengths is not permitted.
- Apply spacing, edge distance, and concrete thickness factors in tables 50 - 51 as necessary to the above values. Compare to the steel values in table 49. The lesser of the values is to be used for the design.
- Data is for temperature range A: Max. short term temperature = 130°F (55°C), max. long term temperature = 110°F (43°C). For temperature range B: Max. short term temperature = 176°F (80°C), max. long term temperature = 110°F (43°C) multiply above values by 0.69.
- Tabular values are for dry concrete or water-saturated concrete conditions. For water-filled drilled holes multiply design strength by 0.52. For submerged (under water) applications multiply design strength by 0.46.
- Tabular values are for short term loads only. For sustained loads including overhead use, see Section 3.1.8.
- Tabular values are for normal-weight concrete only. For lightweight concrete multiply design strength (factored resistance) by λ_a as follows: For sand-lightweight, $\lambda_a = 0.51$. For all-lightweight, $\lambda_a = 0.45$.
- Tabular values are for holes drilled in concrete with carbide tipped hammer drill bit. For diamond core drilling, except as indicated in note 10, multiply uncracked concrete tabular values by 0.57. Diamond core drilling is not permitted for the water-filled or under-water (submerged) applications.
- Diamond core drilling with Hilti TE-YRT roughening tool is permitted for 1/2-13 UNC, 5/8-11 UNC, and 3/4-10 UNC anchors in dry and water-saturated concrete. See Table 83.
- Tabular values are for static loads only. Seismic design is not permitted for uncracked concrete.

Table 81 - Hilti HIT-RE 500 V3 adhesive factored resistance with concrete / bond failure for Hilti HIS-N and HIS-RN internally threaded inserts in cracked concrete^{1,2,3,4,5,6,7,8,9,11}



Thread size	Effective embedment in. (mm)	Tension N_t				Shear V_r			
		$f'_c = 20$ MPa (2,900 psi) lb (kN)	$f'_c = 25$ MPa (3,625 psi) lb (kN)	$f'_c = 30$ MPa (4,350 psi) lb (kN)	$f'_c = 40$ MPa (5,800 psi) lb (kN)	$f'_c = 20$ MPa (2,900 psi) lb (kN)	$f'_c = 25$ MPa (3,625 psi) lb (kN)	$f'_c = 30$ MPa (4,350 psi) lb (kN)	$f'_c = 40$ MPa (5,800 psi) lb (kN)
3/8-16 UNC	4-3/8 (110)	5,280 (23.5)	5,900 (26.2)	6,465 (28.8)	6,985 (31.1)	10,555 (47.0)	11,800 (52.5)	12,925 (57.5)	13,965 (62.1)
1/2-13 UNC ¹⁰	5 (125)	6,395 (28.4)	7,150 (31.8)	7,830 (34.8)	9,040 (40.2)	12,785 (56.9)	14,295 (63.6)	15,660 (69.7)	18,080 (80.4)
5/8-11 UNC ¹⁰	6-3/4 (170)	10,140 (45.1)	11,335 (50.4)	12,420 (55.2)	14,340 (63.8)	20,280 (90.2)	22,675 (100.9)	24,835 (110.5)	28,680 (127.6)
3/4-10 UNC ¹⁰	8-1/8 (205)	13,425 (59.7)	15,010 (66.8)	16,445 (73.1)	18,990 (84.5)	26,855 (119.5)	30,025 (133.5)	32,890 (146.3)	37,975 (168.9)

- See Section 3.1.8 for explanation on development of load values.
- See Section 3.1.8 to convert design strength value to ASD value.
- Linear interpolation between embedment depths and concrete compressive strengths is not permitted.
- Apply spacing, edge distance, and concrete thickness factors in tables 50-51 as necessary to the above values. Compare to the steel values in table 49. The lesser of the values is to be used for the design.
- Data is for temperature range A: Max. short term temperature = 130 (55°C), max. long term temperature = 110°F (43°C). For temperature range B: Max. short term temperature = 176°F (80°C), max. long term temperature = 110°F (43°C) multiply above values by 0.69. Short term elevated concrete temperatures are those that occur over brief intervals, e.g., as a result of diurnal cycling. Long term concrete temperatures are roughly constant over significant periods of time.
- Tabular values are for dry concrete or water-saturated concrete conditions. For water-filled drilled holes multiply design strength by 0.52. For submerged (under water) applications multiply design strength by 0.46.
- Tabular values are for short term loads only. For sustained loads including overhead use, see Section 3.1.8.
- Tabular values are for normal-weight concrete only. For lightweight concrete multiply design strength (factored resistance) by λ_a as follows: For sand-lightweight, $\lambda_a = 0.51$. For all-lightweight, $\lambda_a = 0.45$.
- Tabular values are for holes drilled in concrete with carbide tipped hammer drill bit. Diamond core drilling is not permitted in cracked concrete except as indicated in note 10.
- Diamond core drilling is permitted in cracked concrete with use of the Hilti TE-YRT roughening tool for 1/2-13 UNC, 5/8-11 UNC, and 3/4-10 UNC anchors in dry and water-saturated concrete. See Table 84.
- Tabular values are for static loads only. For seismic loads, multiply cracked concrete tabular values by $\alpha_{seis} = 0.75$. See section 3.1.8 for additional information on seismic applications.



Table 82 - Hilti HIT-RE 500 V3 design information with Hilti HIS-N and HIS-RN internally threaded inserts in core drilled holes roughened with the TE-YRT Roughening Tool in accordance with CSA A23.3-14 Annex D¹

Design parameter	Symbol	Units	Nominal bolt/cap screw diameter (in.)			Ref A23.3-14	
			1/2	5/8	3/4		
HIS insert outside diameter	D	mm	20.5	25.4	27.6		
Effective embedment ²	h_{ef}	mm	125	170	205		
Min. concrete thickness ²	h_{min}	mm	170	230	270		
Critical edge distance	c_{ac}	-	2 h_{ef}				
Minimum edge distance	c_{min}	mm	102	127	140		
Minimum anchor spacing	s_{min}	mm	102	127	140		
Coeff. for factored conc. breakout resistance, uncracked concrete	$k_{c,unscr}^3$	-	10			D.6.2.2	
Coeff. for factored conc. breakout resistance, cracked concrete	$k_{c,scr}^3$	-	7			D.6.2.2	
Concrete material resistance factor	ϕ_c	-	0.65			8.4.2	
Resistance modification factor for tension and shear, concrete failure modes, Condition B ⁵	R_{conc}	-	1.00			D.5.3(c)	
Dry and water saturated concrete							
Temp. range A ⁵	Characteristic bond stress in cracked concrete ^{6,7}	τ_{cr}	psi (MPa)	750 (5.2)	750 (5.2)	750 (5.2)	D.6.5.2
	Characteristic bond stress in uncracked concrete ^{6,7}	τ_{unscr}	psi (MPa)	1,790 (12.3)	1,790 (12.3)	1,790 (12.3)	D.6.5.2
Temp. range B ⁵	Characteristic bond stress in cracked concrete ^{6,7}	τ_{cr}	psi (MPa)	515 (3.6)	515 (3.6)	515 (3.6)	D.6.5.2
	Characteristic bond stress in uncracked concrete ^{6,7}	τ_{unscr}	psi (MPa)	1,240 (8.6)	1,240 (8.6)	1,240 (8.6)	D.6.5.2
Anchor category, dry concrete		-	-	1	1	1	
Resistance modification factor		R_{dry}	-	1.00	1.00	1.00	
Reduction for seismic tension		$\alpha_{N,seis}$	-	1.00	1.00	1.00	

1 Design information in this table is taken from ICC-ES ELC-3814, dated April 2018,, table 29, and converted for use with CSA A23.3-14 Annex D.

2 See figure 8 of section 3.2.4.3.6.

3 For all design cases, $\psi_{c,N} = 1.0$. The appropriate coefficient for breakout resistance for cracked concrete ($k_{c,scr}$) or uncracked concrete ($k_{c,unscr}$) must be used.

4 For use with the load combinations of CSA A23.3-14 chapter 8. Condition B applies where supplementary reinforcement in conformance with CSA A23.3-14 section D.5.3 is not provided, or where pullout or pryout strength governs. For cases where the presence of supplementary reinforcement can be verified, the resistance modification factors associated with Condition A may be used.

5 Temperature range A: Max. short term temperature = 130°F (55°C), max. long term temperature = 110°F (43°C).

Temperature range B: Max. short term temperature = 176°F (80°C), max. long term temperature = 110°F (43°C).

Short term elevated concrete temperatures are those that occur over brief intervals, e.g., as a result of diurnal cycling. Long term concrete temperatures are roughly constant over significant periods of time.

6 Bond stress values correspond to concrete compressive strength in the range 2,500 psi $\leq f'_c \leq$ 8,000 psi.

7 For structures assigned to Seismic Design Categories C, D, E, or F, bond stress values must be multiplied by $\alpha_{N,seis}$.

3.2.3

Table 83 - Hilti HIT-RE 500-V3 adhesive core drilled and roughened with TE-YRT Roughening Tool factored resistance with concrete / bond failure for Hilti HIS-N and HIS-RN internally threaded inserts in uncracked concrete^{1,2,3,4,5,6,7,8}

Thread size	Effective embedment in. (mm)	Tension N_t				Shear V_r			
		$f'_c = 20$ MPa (2,900 psi) lb (kN)	$f'_c = 25$ MPa (3,625 psi) lb (kN)	$f'_c = 30$ MPa (4,350 psi) lb (kN)	$f'_c = 40$ MPa (5,800 psi) lb (kN)	$f'_c = 20$ MPa (2,900 psi) lb (kN)	$f'_c = 25$ MPa (3,625 psi) lb (kN)	$f'_c = 30$ MPa (4,350 psi) lb (kN)	$f'_c = 40$ MPa (5,800 psi) lb (kN)
1/2-13 UNC	5 (125)	9,135 (40.6)	10,210 (45.4)	11,185 (49.8)	12,915 (57.5)	18,265 (81.3)	20,420 (90.8)	22,370 (99.5)	25,830 (114.9)
5/8-11 UNC	6-3/4 (170)	14,485 (64.4)	16,195 (72.0)	17,740 (78.9)	20,485 (91.1)	28,970 (128.9)	32,390 (144.1)	35,480 (157.8)	40,970 (182.2)
3/4-10 UNC	8-1/8 (205)	19,180 (85.3)	21,445 (95.4)	23,490 (104.5)	27,125 (120.7)	38,360 (170.6)	42,890 (190.8)	46,985 (209.0)	54,255 (241.3)

Table 84 - Hilti HIT-RE 500 V3 adhesive core drilled and roughened with TE-YRT Roughening Tool factored resistance with concrete / bond failure for Hilti HIS-N and HIS-RN internally threaded inserts in cracked concrete^{1,2,3,4,5,6,7,8,9}

Thread size	Effective embedment in. (mm)	Tension N_t				Shear V_r			
		$f'_c = 20$ MPa (2,900 psi) lb (kN)	$f'_c = 25$ MPa (3,625 psi) lb (kN)	$f'_c = 30$ MPa (4,350 psi) lb (kN)	$f'_c = 40$ MPa (5,800 psi) lb (kN)	$f'_c = 20$ MPa (2,900 psi) lb (kN)	$f'_c = 25$ MPa (3,625 psi) lb (kN)	$f'_c = 30$ MPa (4,350 psi) lb (kN)	$f'_c = 40$ MPa (5,800 psi) lb (kN)
1/2-13 UNC	5 (125)	6,105 (27.2)	6,105 (27.2)	6,105 (27.2)	6,105 (27.2)	12,215 (54.3)	12,215 (54.3)	12,215 (54.3)	12,215 (54.3)
5/8-11 UNC	6-3/4 (170)	10,140 (45.1)	10,255 (45.6)	10,255 (45.6)	10,255 (45.6)	20,280 (90.2)	20,505 (91.2)	20,505 (91.2)	20,505 (91.2)
3/4-10 UNC	8-1/8 (205)	13,425 (59.7)	13,475 (59.9)	13,475 (59.9)	13,475 (59.9)	26,855 (119.5)	26,955 (119.9)	26,955 (119.9)	26,955 (119.9)

- See Section 3.1.8 for explanation on development of load values.
- See Section 3.1.8 to convert design strength value to ASD value.
- Linear interpolation between embedment depths and concrete compressive strengths is not permitted.
- Apply spacing, edge distance, and concrete thickness factors in tables 50 - 51 as necessary to the above values. Compare to the steel values in table 49. The lesser of the values is to be used for the design.
- Data is for temperature range A: Max. short term temperature = 130°F (55°C), max. long term temperature = 110°F (43°C).
For temperature range B: Max. short term temperature = 176°F (80°C), max. long term temperature = 110°F (43°C) multiply above values by 0.69.
Short term elevated concrete temperatures are those that occur over brief intervals, e.g., as a result of diurnal cycling. Long term concrete temperatures are roughly constant over significant periods of time.
- Tabular values are for dry concrete or water-saturated concrete conditions. Water-filled and submerged (under water) applications are not permitted for this hole preparation method.
- Tabular values are for short term loads only. For sustained loads including overhead use, see Section 3.1.8.
- Tabular values are for normal-weight concrete only. For lightweight concrete multiply design strength (factored resistance) by λ_a as follows:
For sand-lightweight, $\lambda_a = 0.51$. For all-lightweight, $\lambda_a = 0.45$.
- Tabular values are for static loads only. For seismic loads, multiply cracked concrete tabular values by $\alpha_{seis} = 0.75$. See section 3.1.8 for additional information on seismic applications.

Table 85 - Steel factored resistance for steel bolt/cap screw for Hilti HIS-N and HIS-RN internally threaded inserts^{1,2,3}

Thread size	ASTM A193 B7			ASTM A193 Grade B8M Stainless Steel		
	Tensile ⁴ N_{sar} lb (kN)	Shear ⁵ V_{sar} lb (kN)	Seismic Shear ⁶ $V_{sar,eq}$ lb (kN)	Tensile ⁴ N_{sar} lb (kN)	Shear ⁵ V_{sar} lb (kN)	Seismic Shear ⁶ $V_{sar,eq}$ lb (kN)
3/8-16 UNC	5,765 (25.6)	3,215 (14.3)	2,250 (10.0)	5,070 (22.6)	2,825 (12.6)	1,975 (8.8)
1/2-13 UNC	9,635 (42.9)	5,880 (26.2)	4,115 (18.3)	9,290 (41.3)	5,175 (23.0)	3,620 (16.1)
5/8-11 UNC	16,020 (71.3)	9,365 (41.7)	6,555 (29.2)	14,790 (65.8)	8,240 (36.7)	5,770 (25.7)
3/4-10 UNC	16,280 (72.4)	13,860 (61.7)	9,700 (43.1)	21,895 (97.4)	12,195 (54.2)	8,535 (38.0)

- See Section 3.1.8 to convert design strength value to ASD value.
- Hilti HIS-N and HIS-RN inserts with steel bolts are considered brittle steel elements.
- Table values are the lesser of steel failure in the HIS-N insert or inserted steel bolt.
- Tensile = $A_{se,N} \phi_s f_{uta} R$ as noted in CSA A23.3-14 Annex D
- Shear = $A_{se,V} \phi_s 0.60 f_{uta} R$ as noted in CSA A23.3-14 Annex D. For 3/8-in diameter insert, shear = $A_{se,V} \phi_s 0.50 f_{uta} R$.
- Seismic Shear = $\alpha_{seis} V_{sar}$: Reduction factor for seismic shear only. See section 3.1.8 for additional information on seismic applications.

POST-INSTALLED REBAR DESIGN IN CONCRETE PER ACI 318



3.2.4.3.8 Development and splicing of post-installed reinforcement

Calculations for post-installed rebar for typical development lengths may be done according to ACI 318-14 Chapter 25 (formerly ACI 318-11 Chapter 12) and CSA A23.3-14 Chapter 12 for adhesive anchors tested and approved in accordance with AC 308. This section contains tables for the data provided in ICC Evaluation Services ESR-3814. Refer to section 3.1.14 and the Hilti North America Post-Installed Reinforcing Bar Guide for the design method.

Table 86 - Calculated tension development and Class B Splice lengths for Grade 60 bars in walls, slabs, columns, and footings per ACI 318-14 Chapter 25 for Hilti HIT-RE 500 V3

Rebar size	$\frac{c_b + K_{tr}}{d_b}$	min. edge dist. in. ¹	min. spacing in. ²	$f'_c = 2,500$ psi		$f'_c = 3,000$ psi		$f'_c = 4,000$ psi		$f'_c = 6,000$ psi	
				ℓ_d in.	Class B splice in.	ℓ_d in.	Class B splice in.	ℓ_d in.	Class B splice in.	ℓ_d in.	Class B splice in.
#3	2.5	2-1/4	2	12	14	12	13	12	12	12	12
#4		2-3/4	2-1/2	14	19	13	17	12	15	12	12
#5		3	3-1/4	18	23	16	21	14	18	12	15
#6		3-3/4	3-3/4	22	28	20	26	17	22	14	18
#7		4-1/2	4-1/2	32	41	29	37	25	32	20	26
#8		5	5	36	47	33	43	28	37	23	30
#9		5-1/4	5-3/4	41	53	37	48	32	42	26	34
#10		5-3/4	6-1/2	46	59	42	54	36	47	30	38

- Edge distances are determined using the minimum cover specified by ESR-3814 with an additional 6% of the development length per suggestions for drilling without an aid per Hilti Post-Installed Reinforcing Bar Guide Section 3.3. Smaller edge distances may be possible, for which development and splice lengths may need to be recalculated. For further information on required cover see ACI 318-14, Sec. 20.6.1.3.1; see Sec. 2.2 for determination of c_b .
- Spacing values represent those producing $c_b = 5 d_b$ rounded up to the nearest 1/4 in. Smaller spacing values may be possible, for which development and splice lengths may need to be recalculated. For further information on required spacing see ACI 318-14 Sec. 25.2; see Sec. 2.2 for determination of c_b .
- $\psi_t = 1.0$ See ACI 318-14, Sec. 25.4.2.4.
- $\psi_s = 1.0$ for non-epoxy coated bars. See ACI 318-14, Sec. 25.4.2.4.
- $\psi_s = 0.8$ for #6 bars and smaller bars, 1.0 for #7 and larger bars. See ACI 318-14, Sec. 25.4.2.4.
- Values are for normal weight concrete. For sand-lightweight concrete, multiply development and splice lengths by 1.18, for all-lightweight concrete multiply development and splice lengths by 1.33. See ACI 318-14 Sec. 19.2.4.
- Development and splice length values are for static design. Seismic design development and splice lengths can be found in ACI 318-14 18.8.5 for special moment frames and ACI 318-14 18.10.2.3 for special structural walls. For further information about reinforcement in seismic design, see ACI 318-14 Ch. 18.
- Refer to the Hilti North America Post-Installed Reinforcing Bar Guide for further explanation, background information, and design examples.

3.2.3

Table 87 - Suggested embedment, edge distance, and spacing (see figure below) to develop 125% of f_y in Grade 60 bars based on ACI 318-14 Chapter 17 - SDC A and B only^{1,2,3,4,5,6,7}

Rebar size	$f'_c = 2,500$ psi				$f'_c = 3,000$ psi				$f'_c = 4,000$ psi				$f'_c = 6,000$ psi			
	Effective embed. h_{ef} in.	Minimum edge dist $c_{a,min}$ in.		Min. spacing s_{min} in.	Effective embed. h_{ef} in.	Minimum edge dist $c_{a,min}$ in.		Min. spacing s_{min} in.	Effective embed. h_{ef} in.	Minimum edge dist $c_{a,min}$ in.		Min. spacing s_{min} in.	Effective embed. h_{ef} in.	Minimum edge dist $c_{a,min}$ in.		Min. spacing s_{min} in.
		Cond. I	Cond. II			Cond. I	Cond. II			Cond. I	Cond. II			Cond. I	Cond. II	
#3	7	17	8	15	6	16	7	14	6	16	7	13	5	15	6	11
#4	9	23	11	22	9	23	11	21	8	22	10	19	7	20	9	17
#5	11	29	15	29	11	28	14	28	10	27	13	25	9	25	11	22
#6	13	35	19	37	13	34	18	35	12	32	16	32	11	30	14	28
#7	16	41	23	45	15	40	22	43	14	38	20	39	13	36	17	34
#8	18	48	27	54	17	46	26	51	16	44	24	47	15	42	21	41
#9	21	56	32	63	20	54	30	60	18	50	27	54	17	47	24	48
#10	25	65	37	74	24	63	35	70	22	58	32	64	19	54	28	56

- 1 For additional information see May-June 2013 issue of the ACI Structural Journal, "Recommended Procedures for Development and Splicing of Post-Installed Bonded Reinforcing Bars in Concrete Structures" by Charney, Pal and Silva.
- 2 h_{ef} is the calculated bar embedment based on uncracked bond and concrete breakout strengths using equations in section 3.1.14 to develop 125% of nominal bar yield. Bond stresses apply for sustained and non-sustained load conditions. Additional reductions per ACI 318-14, 17.3.1.2 are not included, however, and as such these embedments are not intended for sustained tension load applications. The particular assumptions used for the application of anchor theory to bar development (e.g., bar yield and bond strength values) are a matter of engineering judgment and will in part depend on the specific circumstances of the design. For embedments corresponding to nominal yield (i.e., no overstrength) multiply the unbolded and bolded tabulated h_{ef} values by 0.80 and 0.86, respectively. Reduction factors for non-sustained loading and no bar overstrength may be combined.
- 3 c_a and s are the minimum edge distance and bar spacing (from bar centerline) associated with the tabulated embedments. Refer to sec. 3.1.14 for applicability of edge distance "Condition I" and "Condition II."
- 4 Applicable for hammer-drilled holes. For rock-drilled and core-drilled holes, contact Hilti.
- 5 Values determined with bond stresses, k-factors and strength reduction factors taken from ESR-3814 Tables 12 and 13 assuming dry, uncracked concrete conditions where concrete temperatures will not exceed a maximum short-term temperature of 130°F (55°C) and long-term temperature of 110°F (43°C). Bond stresses are for static (non-seismic) loading conditions.
- 6 Values are for normal weight concrete. For lightweight concrete contact Hilti.
- 7 Refer to the Hilti North America Post-Installed Reinforcing Bar Guide for further explanation, background information, and design examples. See Hilti Instructions for Use (IFU) for specific installation requirements.

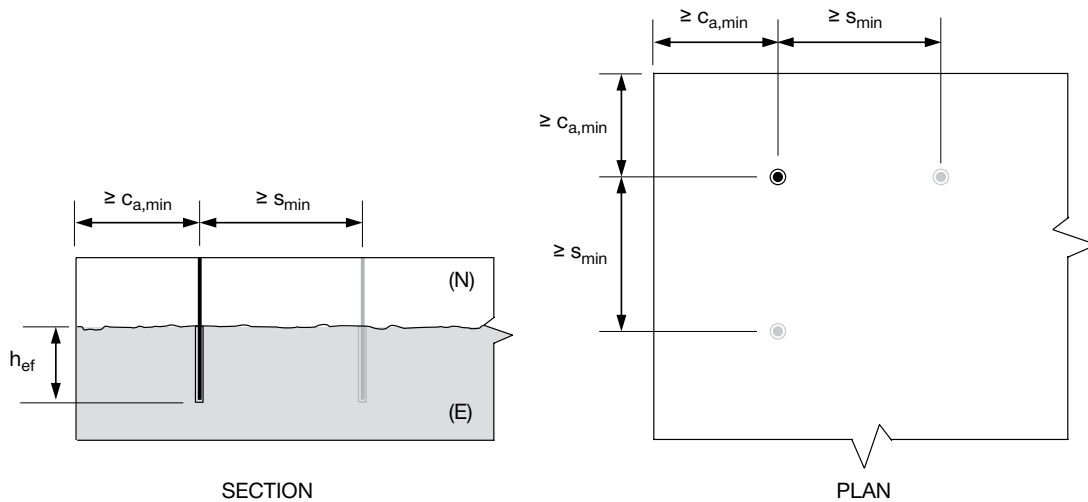

Illustration of Table 84 dimensions

Table 88 - Suggested embedment and edge distance (see figure below) based on ACI 318-14 Chapter 17 to develop 125% of f_y in Grade 60 wall/column starter bars in a linear array with bar spacing = 24 inches - SDC A and B only^{1,2,3,4,5,6}

Rebar size	Linear spacing s in.	$f'_c = 2,500$ psi			$f'_c = 3,000$ psi			$f'_c = 4,000$ psi			$f'_c = 6,000$ psi		
		Effective embed. h_{ef} in.	Minimum edge dist $c_{a,min}$ in.		Effective embed. h_{ef} in.	Minimum edge dist $c_{a,min}$ in.		Effective embed. h_{ef} in.	Minimum edge dist $c_{a,min}$ in.		Effective embed. h_{ef} in.	Minimum edge dist $c_{a,min}$ in.	
			Cond. I	Cond. II		Cond. I	Cond. II		Cond. I	Cond. II		Cond. I	Cond. II
#3	24	7	17	8	6	16	7	6	16	7	5	15	6
#4		9	23	11	9	23	11	8	22	10	7	20	9
#5		13	34	19	11	30	17	10	27	13	9	25	11
#6		21	57	32	19	51	28	15	43	23	11	32	17
#7		-	-	-	-	-	-	24	66	35	18	52	27

- h_{ef} is the calculated bar embedment based on uncracked bond and concrete breakout strengths using equations in section 3.1.14.4 to develop 125% of nominal bar yield. Shaded embedment values exceed 20 bar diameters. For non-tabulated rebar sizes, design per development length provisions is recommended. The particular assumptions used for the application of anchor theory to bar development (e.g., bar yield and bond strength values) are a matter of engineering judgment and will in part depend on the specific circumstances of the design. For embedments corresponding to nominal yield (i.e., no overstrength) multiply the tabulated h_{ef} values by 0.86.
- c_a is the minimum edge distance (from bar centerline) associated with the tabulated embedments and $s = 24$ in. Refer to sec. 3.1.14.3 for applicability of edge distance "Condition I" and "Condition II."
- Applicable for hammer-drilled holes. For rock-drilled and core-drilled holes, contact Hilti.
- Values determined with bond stresses, k-factors and strength reduction factors taken from ESR-3814 Tables 12 and 13 assuming dry concrete conditions where concrete temperatures will not exceed a maximum short-term temperature of 130°F (55°C) and long-term temperature of 110°F (43°C). Bond stresses are for static (non-seismic) loading conditions.
- Values are for normal weight concrete. For lightweight concrete contact Hilti.
- Refer to the Hilti North America Post-Installed Reinforcing Bar Guide for detailed explanation, background information, and design examples. See Hilti Instructions for Use (IFU) for specific installation requirements.

3.2.3

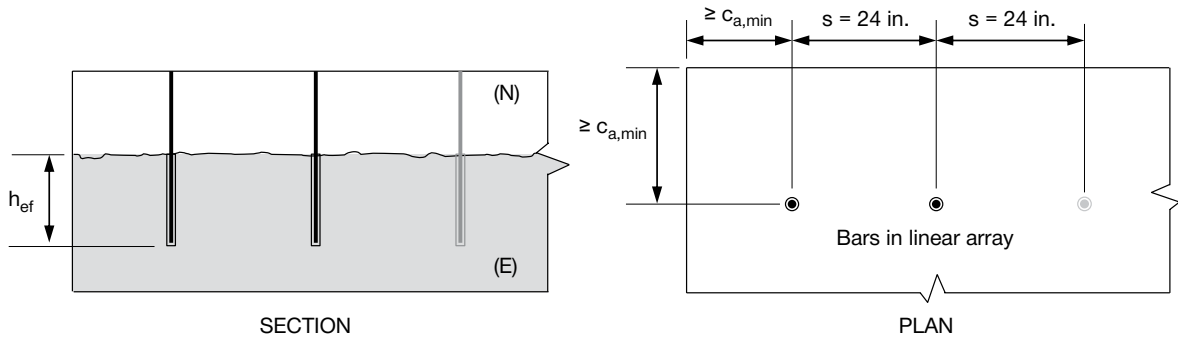

Illustration of Table 85 dimensions

Table 89 - Suggested embedment and edge distance (see figure below) based on ACI 318-14 Chapter 17 to develop 125% of fy in Grade 60 wall/column starter bars in a linear array with bar spacing = 18 inches - SDC A and B only^{1,2,3,4,5,6}

Rebar size	Linear spacing s in.	$f'_c = 2,500$ psi			$f'_c = 3,000$ psi			$f'_c = 4,000$ psi			$f'_c = 6,000$ psi		
		Effective embed. h_{ef} in.	Minimum edge dist $c_{a,min}$ in.		Effective embed. h_{ef} in.	Minimum edge dist $c_{a,min}$ in.		Effective embed. h_{ef} in.	Minimum edge dist $c_{a,min}$ in.		Effective embed. h_{ef} in.	Minimum edge dist $c_{a,min}$ in.	
			Cond. I	Cond. II		Cond. I	Cond. II		Cond. I	Cond. II		Cond. I	Cond. II
#3	18	7	17	8	6	16	7	6	16	7	5	15	6
#4		10	26	14	9	23	13	8	22	10	7	20	9
#5		-	-	-	-	-	-	-	13	36	19	10	28

- h_{ef} is the calculated bar embedment based on uncracked bond and concrete breakout strengths using equations in section 3.1.14.4 to develop 125% of nominal bar yield. Shaded embedment values exceed 20 bar diameters. For non-tabulated rebar sizes, design per development length provisions is recommended. The particular assumptions used for the application of anchor theory to bar development (e.g., bar yield and bond strength values) are a matter of engineering judgment and will in part depend on the specific circumstances of the design. For embedments corresponding to nominal yield (i.e., no overstrength) multiply the tabulated h_{ef} values by 0.86.
- c_a is the minimum edge distance (from bar centerline) associated with the tabulated embedments and $s = 18$ in. Refer to sec. 3.1.14.3 for applicability of edge distance "Condition I" and "Condition II."
- Applicable for hammer-drilled holes. For rock-drilled and core-drilled holes, contact Hilti.
- Values determined with bond stresses, k-factors and strength reduction factors taken from ESR-3814 Tables 12 and 13 assuming dry concrete conditions where concrete temperatures will not exceed a maximum short-term temperature of 130°F (55°C) and long-term temperature of 110°F (43°C). Bond stresses are for static (non-seismic) loading conditions.
- Values are for normal weight concrete. For lightweight concrete contact Hilti.
- Refer to the Hilti North America Post-Installed Reinforcing Bar Guide for detailed explanation, background information, and design examples. See Hilti Instructions for Use (IFU) for specific installation requirements.

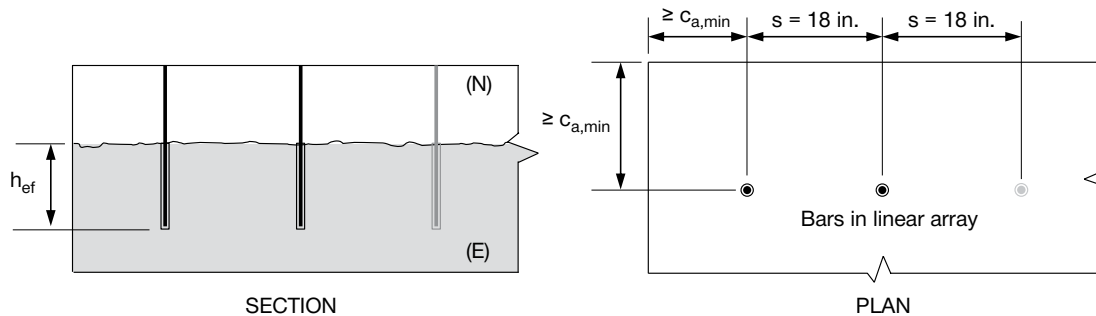

Illustration of Table 86 dimensions

Table 90 - Suggested embedment and edge distance (see figure below) based on ACI 318-14 Chapter 17 to develop 125% of f_y in Grade 60 wall/column starter bars in a linear array with bar spacing = 12 inches - SDC A and B only^{1,2,3,4,5,6}

Rebar size	Linear spacing s in.	$f'_c = 2,500$ psi			$f'_c = 3,000$ psi			$f'_c = 4,000$ psi			$f'_c = 6,000$ psi		
		Effective embed. h_{ef} in.	Minimum edge dist $c_{a,min}$ in.		Effective embed. h_{ef} in.	Minimum edge dist $c_{a,min}$ in.		Effective embed. h_{ef} in.	Minimum edge dist $c_{a,min}$ in.		Effective embed. h_{ef} in.	Minimum edge dist $c_{a,min}$ in.	
			Cond. I	Cond. II		Cond. I	Cond. II		Cond. I	Cond. II		Cond. I	Cond. II
#3	12	7	17	10	6	16	9	6	16	7	5	15	6
#4		-	-	-	-	-	-	11	31	16	8	24	12

- h_{ef} is the calculated bar embedment based on uncracked bond and concrete breakout strengths using equations in section 3.1.14.4 to develop 125% of nominal bar yield. Shaded embedment values exceed 20 bar diameters. For non-tabulated rebar sizes, design per development length provisions is recommended. The particular assumptions used for the application of anchor theory to bar development (e.g., bar yield and bond strength values) are a matter of engineering judgment and will in part depend on the specific circumstances of the design. For embedments corresponding to nominal yield (i.e., no overstrength) multiply the tabulated h_{ef} values by 0.86.
- c_a is the minimum edge distance (from bar centerline) associated with the tabulated embedments and $s = 12$ in. Refer to sec. 3.1.14.3 for applicability of edge distance "Condition I" and "Condition II."
- Applicable for hammer-drilled holes. For rock-drilled and core-drilled holes, contact Hilti.
- Values determined with bond stresses, k-factors and strength reduction factors taken from ESR-3814 Tables 12 and 13 assuming dry concrete conditions where concrete temperatures will not exceed a maximum short-term temperature of 130°F (55°C) and long-term temperature of 110°F (43°C). Bond stresses are for static (non-seismic) loading conditions.
- Values are for normal weight concrete. For lightweight concrete contact Hilti.
- Refer to the Hilti North America Post-Installed Reinforcing Bar Guide for detailed explanation, background information, and design examples. See Hilti Instructions for Use (IFU) for specific installation requirements.

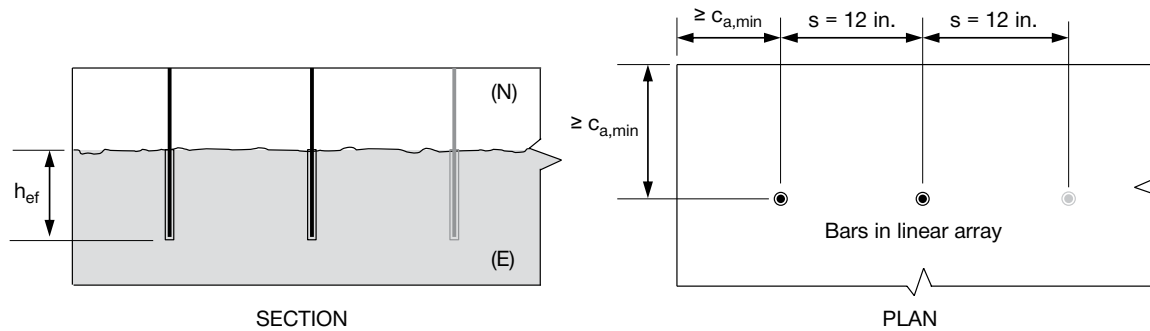

Illustration of Table 87 dimensions

3.2.3

Table 91 - Calculated tension development and Class B Splice lengths for Canadian 400 MPa bars in walls, slabs, columns, and footings per CSA 23.3-14 for Hilti HIT-RE 500 V3 - non-seismic design only^{3,4,5,6,7,8}

Rebar size	$d_{cs} + K_{tr}$	min. edge dist. mm ¹	min. spacing mm ²	$f'_c = 20$ MPa		$f'_c = 25$ MPa		$f'_c = 30$ MPa		$f'_c = 40$ MPa	
				l_d mm	Class B splice mm	l_d mm	Class B splice mm	l_d mm	Class B splice mm	l_d mm	Class B splice mm
10M	2.5 d_b	60	50	300	380	300	340	300	310	300	300
15M		70	75	410	540	370	480	340	440	300	380
20M		80	100	510	660	450	490	410	540	360	460
25M		120	125	820	1,060	730	950	670	870	580	750
30M		130	150	960	1,250	860	1,120	790	1,020	680	890

- 1 Edge distances are determined using the minimum cover specified by ESR-3184 with an additional 6% of the development length per suggestions for drilling without an aid per Hilti Post-Installed Reinforcing Bar Guide Section 3.3. Smaller edge distances may be possible, for which development and splice lengths may need to be recalculated. For further information on required cover see CSA A23.1-14 Table 17; see Sec. 3.2 for determination of d_{cs} .
- 2 Spacing values represent those producing $d_{cs} = 5d_b$. Smaller spacing values may be possible, for which development and splice lengths may need to be recalculated. For further information on required spacing see CSA A23.1 Sec. 6.6.5.2; see Sec. 3.2 for determination of d_{cs} .
- 3 k_1 and k_2 as defined by CSA A23.3-14 12.2.4 (a) and (b), are taken as 1.0 for post-installed reinforcing bars. For additional information see May-June 2013 issue of the ACI Structural Journal, "Recommended Procedures for Development and Splicing of Post-Installed Bonded Reinforcing Bars in Concrete Structures" by Charney, Pal and Silva.
- 4 $k_3 = 0.8$ for 20M bars and smaller bars, 1.0 for 25M and larger bars. See CSA A23.3-14 12.2.4 (d).
- 5 K_{tr} is assumed to equal zero.
- 6 Values are for normal weight concrete. For lightweight concrete, multiply development and splice lengths by 1.3.
- 7 Development and splice length values are for static design. For tension development and splice lengths of bars in joints, see CSA A23.3-14 21.3.3.5. For further information about reinforcement in seismic design, see CSA A23.3-14 Ch. 21.
- 8 Refer to the Hilti North America Post-Installed Reinforcing Bar Guide for further explanation, background information, and design examples.

Table 92 - Suggested embedment, edge distance, and spacing (see figure below) to develop 125% of f_y in Canadian 400 MPa bars based on CSA 23.3-14 Annex D - non-seismic design only^{1,2,3,4,5,6,7}



Rebar size	$f'_c = 20$ MPa				$f'_c = 25$ MPa				$f'_c = 30$ MPa				$f'_c = 40$ MPa			
	Effective embed. h_{ef} mm	Minimum edge dist $C_{a,min}$ in.		Min. spacing s_{min} mm	Effective embed. h_{ef} mm	Minimum edge dist $C_{a,min}$ in.		Min. spacing s_{min} mm	Effective embed. h_{ef} mm	Minimum edge dist $C_{a,min}$ in.		Min. spacing s_{min} mm	Effective embed. h_{ef} mm	Minimum edge dist $C_{a,min}$ in.		Min. spacing s_{min} mm
		Cond. I	Cond. II			Cond. I	Cond. II			Cond. I	Cond. II			Cond. I	Cond. II	
10M	180	480	220	440	170	470	200	400	160	450	190	380	150	430	180	350
15M	260	690	350	690	240	670	320	640	230	650	300	600	220	620	280	550
20M	310	850	450	900	300	820	420	840	280	800	400	790	270	760	360	720
25M	420	1,140	630	1,260	400	1,080	590	1,170	380	1,050	560	1,110	350	1,000	500	1,000
30M	530	1,420	790	1,580	490	1,340	740	1,470	460	1,280	690	1,380	420	1,200	630	1,260

- For additional information see May-June 2013 issue of the ACI Structural Journal, "Recommended Procedures for Development and Splicing of Post-Installed Bonded Reinforcing Bars in Concrete Structures" by Charney, Pal and Silva.
- h_{ef} is the calculated bar embedment based on uncracked bond and concrete breakout strengths using equations in section 3.1.14.3 to develop 125% of nominal bar yield. Bond stresses apply for sustained and non-sustained load conditions. Additional reductions per ACI 318-14, 17.3.1.2 are not included, however, and as such these embedments are not intended for sustained tension load applications. The particular assumptions used for the application of anchor theory to bar development (e.g., bar yield and bond strength values) are a matter of engineering judgment and will in part depend on the specific circumstances of the design. For embedments corresponding to nominal yield (i.e., no overstrength) multiply the unbolded and bolded tabulated h_{ef} values by 0.80 and 0.86, respectively. Reduction factors for non-sustained loading and no bar overstrength may be combined.
- c_a and s are the minimum edge distance and bar spacing (from bar centerline) associated with the tabulated embedments. Refer to sec. 3.1.14.3 for applicability of edge distance "Condition I" and "Condition II."
- Applicable for hammer-drilled holes. For rock-drilled and core-drilled holes, contact Hilti.
- Values determined with bond stresses, k-factors and strength reduction factors taken from ESR-3814 Tables 12 and 13 assuming dry, uncracked concrete conditions where concrete temperatures will not exceed a maximum short-term temperature of 130°F (55°C) and long-term temperature of 110°F (43°C). Bond stresses are for static (non-seismic) loading conditions.
- Values are for normal weight concrete. For lightweight concrete contact Hilti.
- Refer to the Hilti North America Post-Installed Reinforcing Bar Guide for further explanation, background information, and design examples. See Hilti Instructions for Use (IFU) for specific installation requirements.

3.2.3

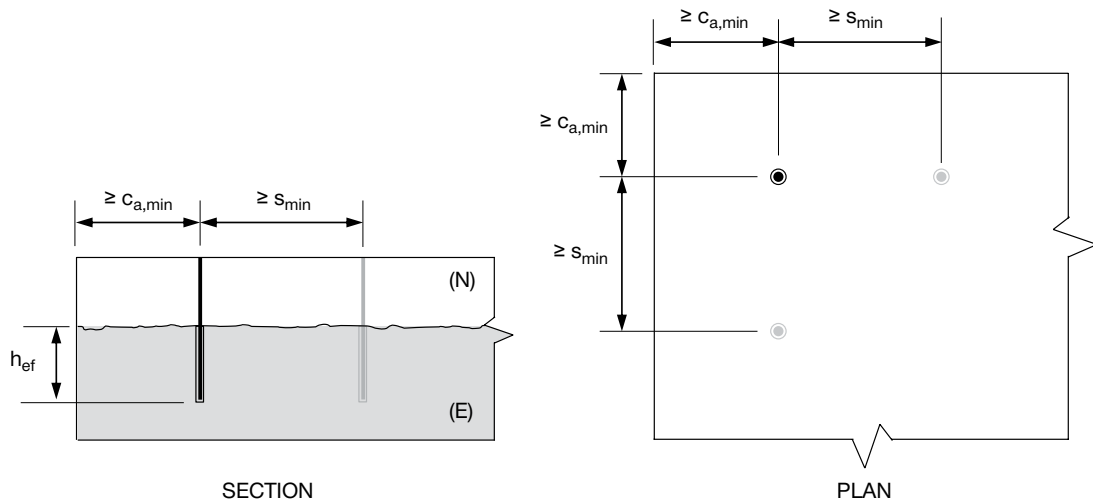

Illustration of Table 89 dimensions

Table 93 - Suggested embedment and edge distance (see figure below) based on CSA 23.3 Annex D to develop 125% of f_y in Canadian 400 MPa wall/column starter bars in a linear array with bar spacing = 600 mm - non-seismic only^{1,2,3,4,5,6}

Rebar size	Linear spacing s mm	$f'_c = 20$ MPa			$f'_c = 25$ MPa			$f'_c = 30$ MPa			$f'_c = 40$ MPa		
		Effective embed. h_{ef} mm	Minimum edge dist $c_{a,min}$ mm		Effective embed. h_{ef} mm	Minimum edge dist $c_{a,min}$ mm		Effective embed. h_{ef} mm	Minimum edge dist $c_{a,min}$ mm		Effective embed. h_{ef} mm	Minimum edge dist $c_{a,min}$ mm	
			Cond. I	Cond. II		Cond. I	Cond. II		Cond. I	Cond. II		Cond. I	Cond. II
10M	600	180	480	220	170	470	200	160	450	190	150	430	180
15M		280	760	420	240	670	350	230	650	300	220	620	280
20M		-	-	-	430	1,220	650	380	1,080	570	310	890	460

- h_{ef} is the calculated bar embedment based on uncracked bond and concrete breakout strengths using equations in section 3.1.14.4 to develop 125% of nominal bar yield. Shaded embedment values exceed 20 bar diameters. For non-tabulated rebar sizes, design per development length provisions is recommended. The particular assumptions used for the application of anchor theory to bar development (e.g., bar yield and bond strength values) are a matter of engineering judgment and will in part depend on the specific circumstances of the design. For embedments corresponding to nominal yield (i.e., no overstrength) multiply the tabulated h_{ef} values by 0.86.
- c_a is the minimum edge distance (from bar centerline) associated with the tabulated embedments and $s = 600$ mm. Refer to sec. 3.1.14.3 for applicability of edge distance "Condition I" and "Condition II."
- Values determined with bond stresses, k-factors and strength reduction factors taken from ESR-3814, Tables 12 and 13 assuming dry, uncracked concrete conditions where concrete temperatures will not exceed a maximum short-term temperature of 130°F (55°C) and long-term temperature of 110°F (43°C). Bond stresses are for static (non-seismic) loading conditions.
- Values are for normal weight concrete. For lightweight concrete contact Hilti.
- Refer to the Hilti North America Post-Installed Reinforcing Bar Guide for further explanation, background information, and design examples. See Hilti Instructions for Use (IFU) for specific installation requirements.

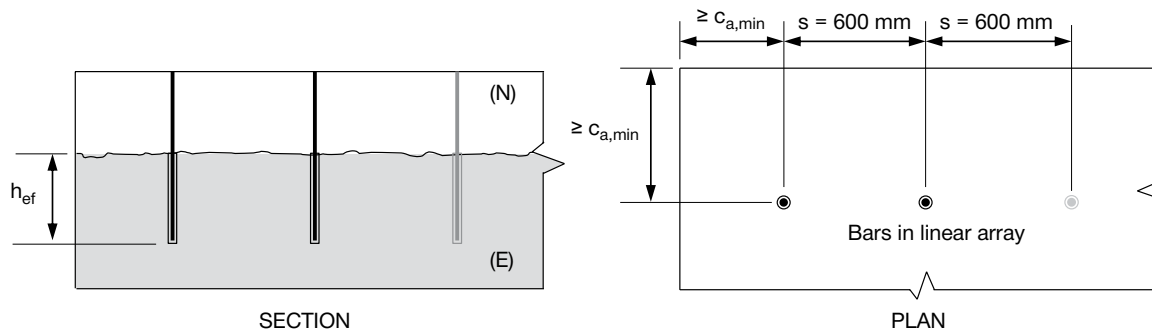

Illustration of Table 90 dimensions

Table 94 - Suggested embedment and edge distance (see figure below) based on CSA 23.3 Annex D to develop 125% f_y in Canadian 400 MPa wall/column starter bars in a linear array with bar spacing = 450 mm - non-seismic only^{1,2,3,4,5,6}

Rebar size	Linear spacing s mm	$f'_c = 20$ MPa			$f'_c = 25$ MPa			$f'_c = 30$ MPa			$f'_c = 40$ MPa		
		Effective embed. h_{ef} mm	Minimum edge dist $c_{a,min}$ mm		Effective embed. h_{ef} mm	Minimum edge dist $c_{a,min}$ mm		Effective embed. h_{ef} mm	Minimum edge dist $c_{a,min}$ mm		Effective embed. h_{ef} mm	Minimum edge dist $c_{a,min}$ mm	
			Cond. I	Cond. II		Cond. I	Cond. II		Cond. I	Cond. II		Cond. I	Cond. II
10M	450	180	480	220	170	470	200	160	450	190	150	430	180
15M		400	1,090	590	340	950	510	300	840	440	240	690	360

- h_{ef} is the calculated bar embedment based on uncracked bond and concrete breakout strengths using equations in section 3.1.14.4 to develop 125% of nominal bar yield. Shaded embedment values exceed 20 bar diameters. For non-tabulated rebar sizes, design per development length provisions is recommended. The particular assumptions used for the application of anchor theory to bar development (e.g., bar yield and bond strength values) are a matter of engineering judgment and will in part depend on the specific circumstances of the design. For embedments corresponding to nominal yield (i.e., no overstrength) multiply the tabulated h_{ef} values by 0.86.
- c_a is the minimum edge distance (from bar centerline) associated with the tabulated embedments and $s = 450$ mm. Refer to sec. 3.1.14.3 for applicability of edge distance "Condition I" and "Condition II."
- Values determined with bond stresses, k-factors and strength reduction factors taken from ESR-3814, Tables 12 and 13 assuming dry, uncracked concrete conditions where concrete temperatures will not exceed a maximum short-term temperature of 130°F (55°C) and long-term temperature of 110°F (43°C). Bond stresses are for static (non-seismic) loading conditions.
- Values are for normal weight concrete. For lightweight concrete contact Hilti.
- Refer to the Hilti North America Post-Installed Reinforcing Bar Guide for further explanation, background information, and design examples. See Hilti Instructions for Use (IFU) for specific installation requirements.

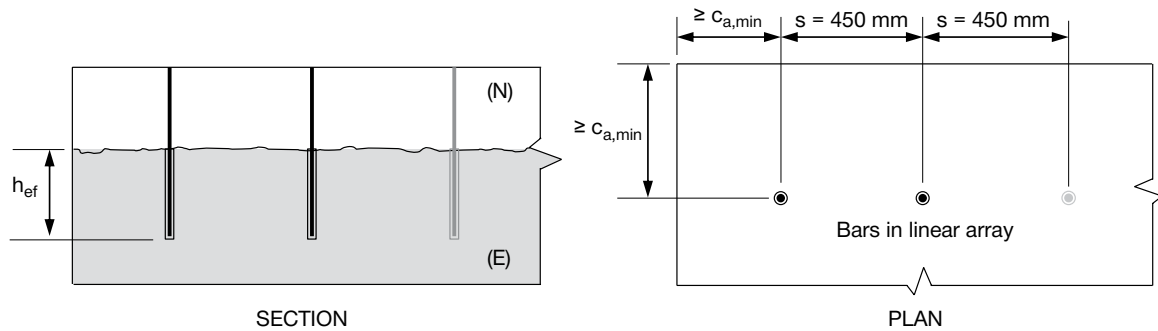

Illustration of Table 91 dimensions

3.2.3

Table 95 - Suggested embedment and edge distance (see figure below) based on CSA 23.3 Annex D to develop 125% of f_y in Canadian 400 MPa wall/column starter bars in a linear array with bar spacing = 300 mm - non-seismic only^{1,2,3,4,5,6}

Rebar size	Linear spacing s mm	$f'_c = 20$ MPa				$f'_c = 25$ MPa				$f'_c = 30$ MPa				$f'_c = 40$ MPa			
		Effective embed. h_{ef} mm	Minimum edge dist $c_{a,min}$ mm		Effective embed. h_{ef} mm	Minimum edge dist $c_{a,min}$ mm		Effective embed. h_{ef} mm	Minimum edge dist $c_{a,min}$ mm		Effective embed. h_{ef} mm	Minimum edge dist $c_{a,min}$ mm		Effective embed. h_{ef} mm	Minimum edge dist $c_{a,min}$ mm		
			Cond. I	Cond. II		Cond. I	Cond. II		Cond. I	Cond. II		Cond. I	Cond. II		Cond. I	Cond. II	
10M	300	240	650	350	200	560	300	180	500	260	160	450	210				

- 1 h_{ef} is the calculated bar embedment based on uncracked bond and concrete breakout strengths using equations in section 3.1.14.4 to develop 125% of nominal bar yield. Shaded embedment values exceed 20 bar diameters. For non-tabulated rebar sizes, design per development length provisions is recommended. The particular assumptions used for the application of anchor theory to bar development (e.g., bar yield and bond strength values) are a matter of engineering judgment and will in part depend on the specific circumstances of the design. For embedments corresponding to nominal yield (i.e., no overstrength) multiply the tabulated h_{ef} values by 0.86.
- 2 c_a is the minimum edge distance (from bar centerline) associated with the tabulated embedments and $s = 300$ mm. Refer to sec. 3.1.14.3 for applicability of edge distance "Condition I" and "Condition II."
- 4 Values determined with bond stresses, k-factors and strength reduction factors taken from ESR-3814, Tables 12 and 13 assuming dry, uncracked concrete conditions where concrete temperatures will not exceed a maximum short-term temperature of 130°F (55°C) and long-term temperature of 110°F (43°C). Bond stresses are for static (non-seismic) loading conditions.
- 5 Values are for normal weight concrete. For lightweight concrete contact Hilti.
- 6 Refer to the Hilti North America Post-Installed Reinforcing Bar Guide for further explanation, background information, and design examples. See Hilti Instructions for Use (IFU) for specific installation requirements.

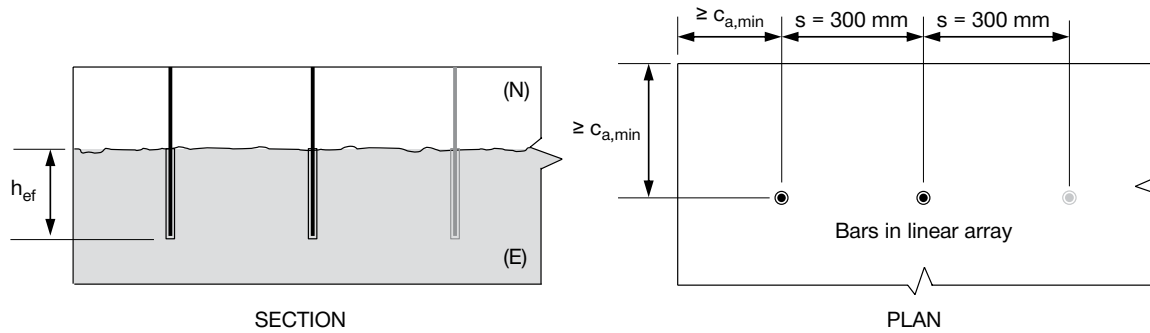



Illustration of Table 92 dimensions

INSTALLATION INSTRUCTIONS

Installation Instructions For Use (IFU) are included with each product package. They can also be viewed or downloaded online at www.hilti.com. Because of the possibility of changes, always verify that downloaded IFU are current when used. Proper installation is critical to achieve full performance. Training is available on request. Contact Hilti Technical Services for applications and conditions not addressed in the IFU.

MATERIAL SPECIFICATIONS

Figure 9 - Hilti HIT-RE 500 V3 adhesive cure and working time (approx.)

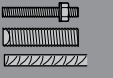
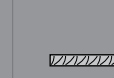
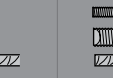
					
	[°F]	[°C]	t _{work}	t _{cure, ini}	t _{cure, full}
	23	-5	2 h	48 h	168 h
	32	0	2 h	24 h	36 h
	40	4	2 h	16 h	24 h
	50	10	1.5 h	12 h	16 h
	60	16	1 h	8 h	16 h
	72	22	25 min	4 h	6.5 h
	85	29	15 min	2.5 h	5 h
	95	35	12 min	2 h	4.5 h
	105	41	10 min	2 h	4 h



 ≥ +5 °C / 41 °F  = 2x t_{cure}

Table 96 - Resistance of cured Hilti HIT-RE 500 V3 to chemicals

Chemicals tested	Content (%)	Resistance
toluene	47.5	+
iso-octane	30.4	
heptane	17.1	
methanol	3	
butanol	2	+
toluene	60	
xylene	30	
methylnaphthalene	10	
diesel	100	+
petrol	100	+
methanol	100	-
dichloromethane	100	-
mono-chlorobenzene	100	●
ethylacetat	50	+
methylisobutylketone	50	
salicylic acid-methylester	50	+
mcetophenon	50	
acetic acid	50	-
propionic acid	50	-
sulfuric acid	100	-
nitric acid	100	-
hydochloric acid	36	-
potassium hydroxide	100	-
sodium hydroxide 20%	100	-
triethanolamine	50	-
butylamine	50	
benzyl alcohol	100	-
ethanol	100	
ethyl acetate	100	
methyl ethly ketone (MEK)	100	
trichlorethylene	100	
lutensit TC KLC 50	3	
marlophen NP 9,5	2	+
water	95	
tetrahydrofurane	100	-
demineralized water	100	+
salt water	saturated	+
salt spray testing	-	+
SO ₂	-	+
environment/weather	-	+
oil for formwork (forming oil)	100	+
concrete plasticizer	-	+
concrete drilling mud	-	+
concrete potash solution	-	+
saturated suspension of bore-hole cuttings	-	+

- + Resistant
- Partially resistant
- Not resistant

3.2.3

ORDERING INFORMATION



HIT-RE 500 V3

Description	Package contents	Qty
HIT-RE 500 V3 (11.1 fl oz/330 ml)	Includes (1) foil pack with (1) mixer and 3/8 filler tube per pack	1
HIT-RE 500 V3 Master Carton (11.1 fl oz/330 ml)	Includes (1) master carton containing (25) foil packs with (1) mixer and 3/8 filler tube per pack	25
HIT-RE 500 V3 Combo (11.1 fl oz/330 ml)	Includes (1) master carton containing (25) foil packs with (1) mixer and 3/8 filler tube per pack and (1) HDM 500 Manual Dispenser	25
HIT-RE 500 V3 Master Carton (16.9 fl oz/500 ml)	Includes (1) master carton containing (20) foil packs with (1) mixer and 3/8 filler tube per pack	20
HIT-RE 500 V3 Combo (16.9 fl oz/500 ml)	Includes (2) master cartons containing (20) foil packs each with (1) mixer and 3/8 filler tube per pack and (1) HDM 500 Manual Dispenser	40
HIT-RE 500 V3 (47.3 fl oz/1400 ml)	Includes (4) foil packs with (1) mixer and 3/8 filler tube per pack	4
HIT-RE 500 V3 Pallet (47.3 fl oz/1400 ml)	Includes (64) foil packs with (1) mixer and 3/8 filler tube per pack and (1) P800 Pneumatic Dispenser	64
HIT-RE 500 V3 TE-CD Starter Package	Includes foil packs, dispensers, vacuum, hammer drill and various drill bit sizes. Contact Hilti for exact package contents.	40
HIT-RE 500 V3 TE-YD Starter Package	Includes foil packs, dispensers, vacuum, hammer drill and various drill bit sizes. Contact Hilti for exact package contents.	40
HIT-RE-M Static Mixer For use with HIT-RE 500 V3 cartridges		1



TE-YRT Roughening Tool

Order description	Description	Length
TE-YRT 7/8" x 15"	Roughening tool for use with 3/4" diameter threaded rod in core drilled holes	15"
TE-YRT 1-1/8" x 20"	Roughening tool for use with 1" diameter threaded rod in core drilled holes	20"
TE-YRT 1-3/8" x 25"	Roughening tool for use with 1-1/4" diameter threaded rod in core drilled holes	25"
RTG 7/8"	Roughening tool gauge for TE-YRT 7/8"	
RTG 1-1/8"	Roughening tool gauge for TE-YRT 1-1/8"	
RTG 1-3/8"	Roughening tool gauge for TE-YRT 1-3/8"	



TE-CD Hollow Drill Bits

Order description	Working length
Hollow Drill Bit TE-CD 1/2" x 13"	8"
Hollow Drill Bit TE-CD 9/16" x 14"	9-1/2"
Hollow Drill Bit TE-CD 5/8" x 14"	9-1/2"
Hollow Drill Bit TE-CD 3/4" x 14"	9-1/2"



TE-YD Hollow Drill Bits

Order description	Working length
Hollow drill bit TE-YD 5/8" x 24"	15-3/4"
Hollow drill bit TE-YD 3/4" x 24"	15-3/4"
Hollow drill bit TE-YD 7/8" x 24"	15-3/4"
Hollow drill bit TE-YD 1" x 24"	15-3/4"
Hollow drill bit TE-YD 1-1/8" x 24"	15-3/4"
Hollow drill bit TE-YD 5/8" x 35"	26"
Hollow drill bit TE-YD 3/4" x 35"	26"
Hollow drill bit TE-YD 7/8" x 35"	26"
Hollow drill bit TE-YD 1" x 35"	26"
Hollow drill bit TE-YD 1-1/8" x 47"	39"